



**THE DATASHEET OF
CLS4D11-150**



Type: CLS4D11

Product Description

- 4.9 × 4.9mm Max.(L × W), 1.2mm Max. Height.
- 4 Terminal pins' type gives a flexible design as inductors or transformers (SEPIC,ZETA circuit).
- Custom design is available.

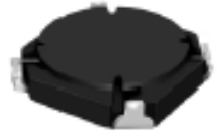

Feature

- Max. Operating frequency 1MHz, Max.
- Ideally used in portable devices such as Mobilephone,DSC/DVC,MP3,PDA, etc as DC-DC Converter inductors, specially suitable for White LED drive.
- It is possible to output high voltage and get sufficient accuracy which is hard to obtain with an ordinary inductor.
- RoHS Compliance

Dimensions (mm)

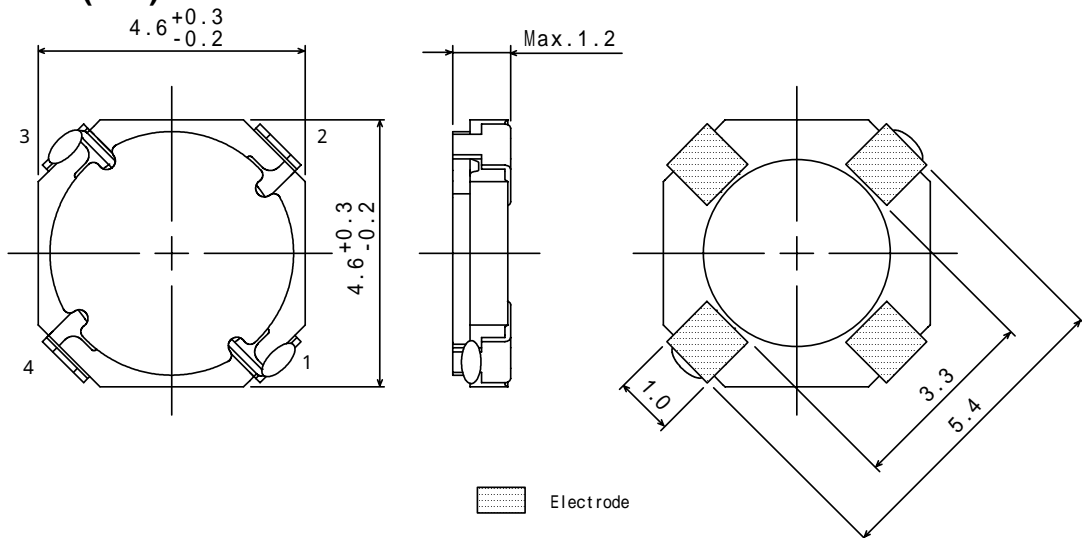

Land Pattern (mm)

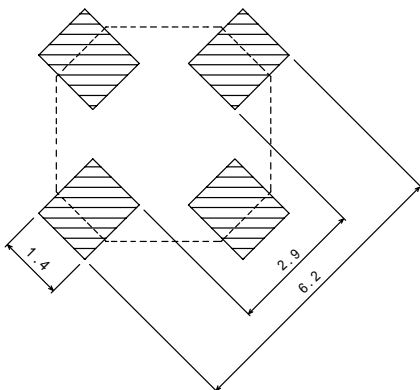

Schematics (Bottom)

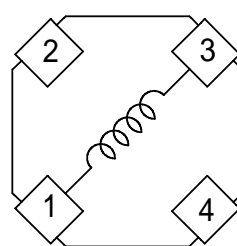

For Inductor

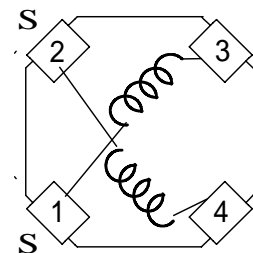

For 2 in 1 Transformer

Type: CLS4D11
Specification (For Inductor)

Part No.	Stamp	Inductance [within] (at 100kHz)	D.C.R.(m Ω) Max.(Typ.) (at 20 $^{\circ}$ C)	Rated current (mA) 1
CLS4D11 - 3R3N	3R3	3.3 μ H \pm 30%	120(95)	1000
CLS4D11 - 4R7N	4R7	4.7 μ H \pm 30%	180(140)	800
CLS4D11 - 6R8N	6R8	6.8 μ H \pm 30%	220(170)	700
CLS4D11 - 10 \emptyset N	100	10 μ H \pm 30%	310(240)	600
CLS4D11 - 15 \emptyset N	150	15 μ H \pm 30%	480(370)	500
CLS4D11 - 22 \emptyset N	220	22 μ H \pm 30%	710(550)	400
CLS4D11 - 33 \emptyset N	330	33 μ H \pm 30%	1100(870)	300

Description of part name

CLS4D11 - 3R3N

	B	Box
	C	Carrier Tape

1. Rated current: The D.C. current at which the inductance decreases to 65% of it's nominal value or when $t=40^{\circ}$ C, whichever is lower($T_a=20^{\circ}$ C).



Specification (For 2 in 1 Transformer)

Sample No.	Inductance (at 100kHz)	D.C.R.(m Ω) Max. (at 20 $^{\circ}$ C)	Rated current (mA)
5365-T007	4.7 μ H \pm 30%	380	500

Rated current: The DC current at which the inductance decreases to 90 % of it's initial value or when $t=40^{\circ}$ C, whichever is lower($T_a=20^{\circ}$ C).

Looking for pricing, stock, or lifecycle information?

Click below to explore more details on WIN SOURCE:

-  [View CLS4D11-150 on WIN SOURCE](#)
-  [Sumida America Components Inc. Information](#)

Optimize Your Supply Chain with WIN SOURCE Solutions

-  Global Sourcing Solution
-  Obsolete Management
-  Cost Control Management
-  Shortage Management
-  Alternative Solution
-  Excess Inventory Management