



**THE DATASHEET OF
VS-31DQ05**





Schottky Rectifier, 3.3 A

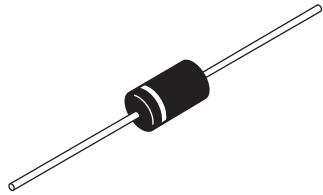

C-16



FEATURES

- Low profile, axial leaded outline
- High frequency operation
- Very low forward voltage drop
- High purity, high temperature epoxy encapsulation for enhanced mechanical strength and moisture resistance
- Guard ring for enhanced ruggedness and long term reliability
- Compliant to RoHS Directive 2002/95/EC
- Designed and qualified for commercial level
- Halogen-free according to IEC 61249-2-21 definition (-M3 only)



| PRODUCT SUMMARY | |
|-----------------|----------------------|
| Package | DO-201AD (C-16) |
| $I_{F(AV)}$ | 3.3 A |
| V_R | 50 V, 60 V |
| V_F at I_F | See Electrical table |
| I_{RM} max. | 15 mA at 125 °C |
| T_J max. | 150 °C |
| Diode variation | Single die |
| E_{AS} | 5.0 mJ |

DESCRIPTION

The VS-31DQ... axial leaded Schottky rectifier has been optimized for very low forward voltage drop, with moderate leakage. Typical applications are in switching power supplies, converters, freewheeling diodes, and reverse battery protection

| MAJOR RATINGS AND CHARACTERISTICS | | | |
|-----------------------------------|--|-------------|-------|
| SYMBOL | CHARACTERISTICS | VALUES | UNITS |
| $I_{F(AV)}$ | Rectangular waveform | 3.3 | A |
| V_{RRM} | | 50/60 | V |
| I_{FSM} | $t_p = 5 \mu s$ sine | 340 | A |
| V_F | 3 Apk, $T_J = 25 \text{ }^\circ\text{C}$ | 0.62 | V |
| T_J | | - 40 to 150 | °C |

| VOLTAGE RATINGS | | | | | | |
|--------------------------------------|-----------|-----------|--------------|-----------|--------------|-------|
| PARAMETER | SYMBOL | VS-31DQ05 | VS-31DQ05-M3 | VS-31DQ06 | VS-31DQ06-M3 | UNITS |
| Maximum DC reverse voltage | V_R | 50 | 50 | 60 | 60 | V |
| Maximum working peak reverse voltage | V_{RWM} | | | | | |

| ABSOLUTE MAXIMUM RATINGS | | | | | |
|---|-------------|---|---|--------|-------|
| PARAMETER | SYMBOL | TEST CONDITIONS | | VALUES | UNITS |
| Maximum average forward current See fig. 4 | $I_{F(AV)}$ | 50 % duty cycle at $T_L = 105 \text{ }^\circ\text{C}$, rectangular waveform | | 3.3 | A |
| Maximum peak one cycle non-repetitive surge current See fig. 6 | I_{FSM} | 5 μs sine or 3 μs rect. pulse | Following any rated load condition and with rated V_{RRM} applied | 340 | |
| | | 10 ms sine or 6 ms rect. pulse | | 55 | |
| Non-repetitive avalanche energy | E_{AS} | $T_J = 25 \text{ }^\circ\text{C}$, $I_{AS} = 1 \text{ A}$, $L = 10 \text{ mH}$ | | 5.0 | mJ |
| Repetitive avalanche current | I_{AR} | Current decaying linearly to zero in 1 μs Frequency limited by T_J maximum $V_A = 1.5 \times V_R$ typical | | 1.0 | A |



| ELECTRICAL SPECIFICATIONS | | | | | |
|---|----------------|--|-----------------------------------|--------|------------|
| PARAMETER | SYMBOL | TEST CONDITIONS | | VALUES | UNITS |
| Maximum forward voltage drop See fig. 1 | $V_{FM}^{(1)}$ | 3 A | $T_J = 25\text{ }^\circ\text{C}$ | 0.62 | V |
| | | 6 A | | 0.78 | |
| | | 3 A | $T_J = 125\text{ }^\circ\text{C}$ | 0.54 | |
| | | 6 A | | 0.65 | |
| Maximum reverse leakage current See fig. 4 | $I_{RM}^{(1)}$ | $T_J = 25\text{ }^\circ\text{C}$ | $V_R = \text{Rated } V_R$ | 2 | mA |
| | | $T_J = 125\text{ }^\circ\text{C}$ | | 15 | |
| Typical junction capacitance | C_T | $V_R = 5 V_{DC}$ (test signal range 100 kHz to 1 MHz) $25\text{ }^\circ\text{C}$ | | 160 | pF |
| Typical series inductance | L_S | Measured lead to lead 5 mm from package body | | 9.0 | nH |
| Maximum voltage rate of charge | dV/dt | Rated V_R | | 10 000 | V/ μ s |

Note(1) Pulse width < 300 μ s, duty cycle < 2 %

| THERMAL - MECHANICAL SPECIFICATIONS | | | | | |
|---|----------------------|-------------------------------------|--|-------------|--------------------|
| PARAMETER | SYMBOL | TEST CONDITIONS | | VALUES | UNITS |
| Maximum junction and storage temperature range | $T_J^{(1)}, T_{Stg}$ | | | - 40 to 150 | $^\circ\text{C}$ |
| Maximum thermal resistance, junction to ambient | R_{thJA} | DC operation Without cooling fin | | 80 | $^\circ\text{C/W}$ |
| Typical thermal resistance, junction to lead | R_{thJL} | DC operation | | 15 | |
| Approximate weight | | | | 1.2 | g |
| | | | | 0.042 | oz. |
| Marking device | | Case style C-16 | | 31DQ05 | |
| | | | | 31DQ06 | |

Note(1) $\frac{dP_{tot}}{dT_J} < \frac{1}{R_{thJA}}$ thermal runaway condition for a diode on its own heatsink

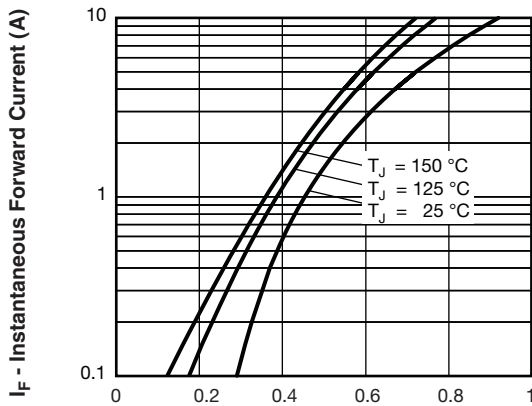

93320_01 **V_{FM} - Forward Voltage Drop (V)**
Fig. 1 - Maximum Forward Voltage Drop Characteristics

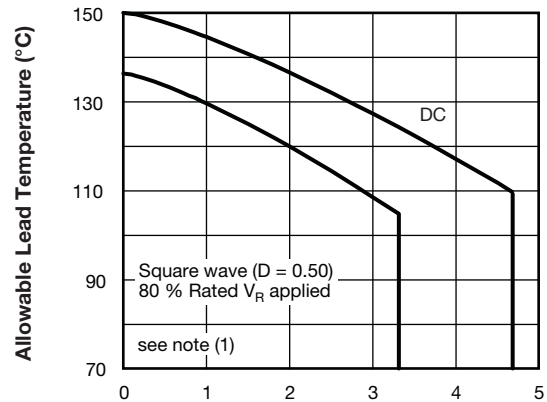

93320_04 **I_{F(AV)} - Average Forward Current (A)**
Fig. 4 - Maximum Allowable Lead Temperature vs. Average Forward Current

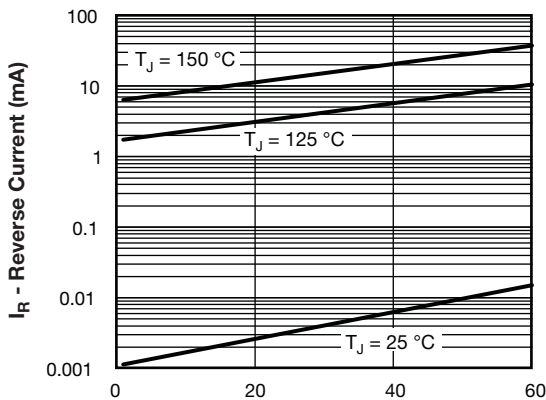

93320_02 **V_R - Reverse Voltage (V)**
Fig. 2 - Typical Values of Reverse Current vs. Reverse Voltage

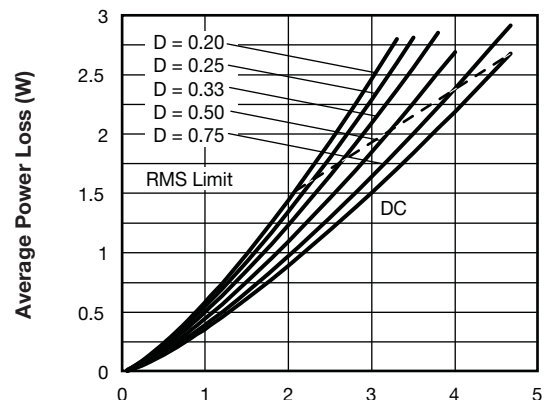

93320_05 **Average Forward Current - I_{F(AV)} (A)**
Fig. 5 - Forward Power Loss Characteristics

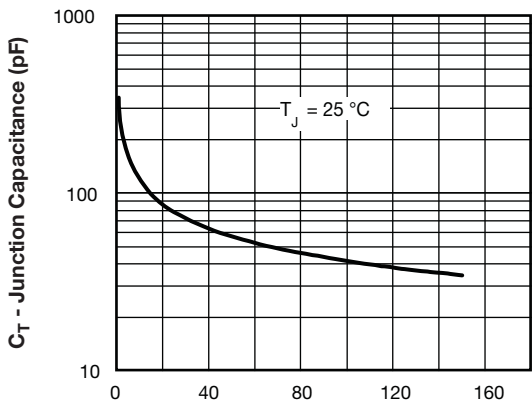

93320_03 **V_R - Reverse Voltage (V)**
Fig. 3 - Typical Junction Capacitance vs. Reverse Voltage

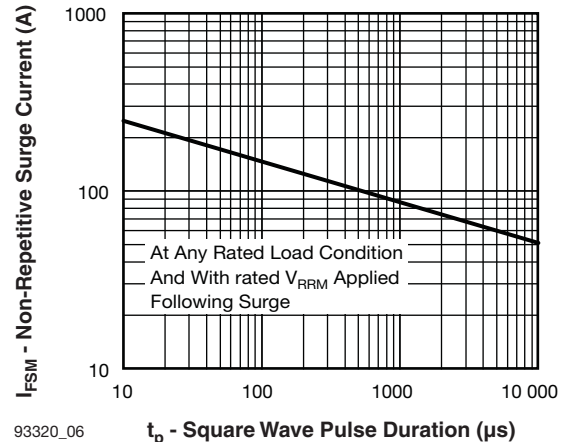

93320_06 **t_p - Square Wave Pulse Duration (μs)**
Fig. 6 - Maximum Non-Repetitive Surge Current

Note

(1) Formula used: $T_C = T_J - (Pd + Pd_{REV}) \times R_{thJC}$;
Pd = Forward power loss = $I_{F(AV)} \times V_{FM}$ at $(I_{F(AV)}/D)$ (see fig. 6); Pd_{REV} = Inverse power loss = $V_{R1} \times I_R (1 - D)$; I_R at V_{R1} = 80 % rated V_R



ORDERING INFORMATION TABLE

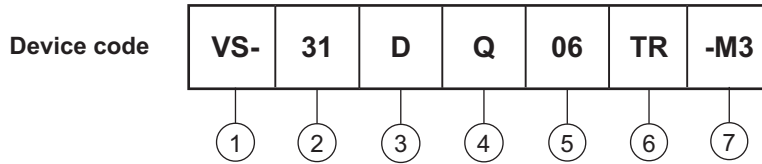

- 1** - Vishay Semiconductors product
- 2** - 31 = Current Rating, 3.3 A
- 3** - D = DO-201 package
- 4** - Q = Schottky Q.. series
- 5** - 06 = Voltage ratings 05 = 50 V
06 = 60 V
- 6** -
 - TR = Tape and reel package
 - None = Bulk package
- 7** - Environmental digit
 - None = Lead (Pb)-free and RoHS compliant
 - -M3 = Halogen-free, RoHS compliant, and terminations lead (Pb)-free

| ORDERING INFORMATION (Example) | | | |
|--------------------------------|------------------|------------------------|-----------------------|
| PREFERRED P/N | QUANTITY PER T/R | MINIMUM ORDER QUANTITY | PACKAGING DESCRIPTION |
| VS-31DQ05 | 500 | 500 | Bulk |
| VS-31DQ05TR | 1200 | 1200 | Tape and reel |
| VS-31DQ05-M3 | 500 | 500 | Bulk |
| VS-31DQ05TR-M3 | 1200 | 1200 | Tape and reel |
| VS-31DQ06 | 500 | 500 | Bulk |
| VS-31DQ06TR | 1200 | 1200 | Tape and reel |
| VS-31DQ06-M3 | 500 | 500 | Bulk |
| VS-31DQ06TR-M3 | 1200 | 1200 | Tape and reel |

| LINKS TO RELATED DOCUMENTS | |
|----------------------------|--|
| Dimensions | www.vishay.com/doc?95242 |
| Part marking information | www.vishay.com/doc?95304 |
| Packaging information | www.vishay.com/doc?95338 |



Axial DO-201AD (C-16)

DIMENSIONS in millimeters (inches)

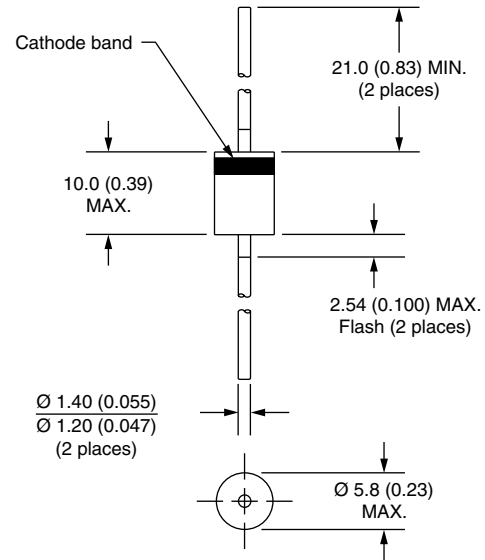
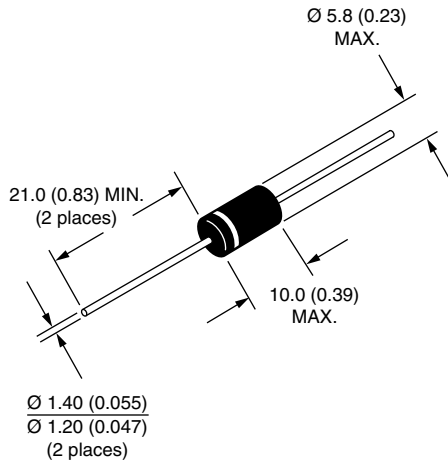



Disclaimer

ALL PRODUCT, PRODUCT SPECIFICATIONS AND DATA ARE SUBJECT TO CHANGE WITHOUT NOTICE TO IMPROVE RELIABILITY, FUNCTION OR DESIGN OR OTHERWISE.

Vishay Intertechnology, Inc., its affiliates, agents, and employees, and all persons acting on its or their behalf (collectively, "Vishay"), disclaim any and all liability for any errors, inaccuracies or incompleteness contained in any datasheet or in any other disclosure relating to any product.

Vishay makes no warranty, representation or guarantee regarding the suitability of the products for any particular purpose or the continuing production of any product. To the maximum extent permitted by applicable law, Vishay disclaims (i) any and all liability arising out of the application or use of any product, (ii) any and all liability, including without limitation special, consequential or incidental damages, and (iii) any and all implied warranties, including warranties of fitness for particular purpose, non-infringement and merchantability.

Statements regarding the suitability of products for certain types of applications are based on Vishay's knowledge of typical requirements that are often placed on Vishay products in generic applications. Such statements are not binding statements about the suitability of products for a particular application. It is the customer's responsibility to validate that a particular product with the properties described in the product specification is suitable for use in a particular application. Parameters provided in datasheets and/or specifications may vary in different applications and performance may vary over time. All operating parameters, including typical parameters, must be validated for each customer application by the customer's technical experts. Product specifications do not expand or otherwise modify Vishay's terms and conditions of purchase, including but not limited to the warranty expressed therein.

Except as expressly indicated in writing, Vishay products are not designed for use in medical, life-saving, or life-sustaining applications or for any other application in which the failure of the Vishay product could result in personal injury or death. Customers using or selling Vishay products not expressly indicated for use in such applications do so at their own risk. Please contact authorized Vishay personnel to obtain written terms and conditions regarding products designed for such applications.

No license, express or implied, by estoppel or otherwise, to any intellectual property rights is granted by this document or by any conduct of Vishay. Product names and markings noted herein may be trademarks of their respective owners.

Material Category Policy

Vishay Intertechnology, Inc. hereby certifies that all its products that are identified as RoHS-Compliant fulfill the definitions and restrictions defined under Directive 2011/65/EU of The European Parliament and of the Council of June 8, 2011 on the restriction of the use of certain hazardous substances in electrical and electronic equipment (EEE) - recast, unless otherwise specified as non-compliant.

Please note that some Vishay documentation may still make reference to RoHS Directive 2002/95/EC. We confirm that all the products identified as being compliant to Directive 2002/95/EC conform to Directive 2011/65/EU.

Vishay Intertechnology, Inc. hereby certifies that all its products that are identified as Halogen-Free follow Halogen-Free requirements as per JEDEC JS709A standards. Please note that some Vishay documentation may still make reference to the IEC 61249-2-21 definition. We confirm that all the products identified as being compliant to IEC 61249-2-21 conform to JEDEC JS709A standards.

Looking for pricing, stock, or lifecycle information?

Click below to explore more details on WIN SOURCE:

 [View VS-31DQ05 on WIN SOURCE](#)

 [Vishay Information](#)

Optimize Your Supply Chain with WIN SOURCE Solutions

-  Global Sourcing Solution
-  Obsolete Management
-  Cost Control Management
-  Shortage Management
-  Alternative Solution
-  Excess Inventory Management