



THE DATASHEET OF SS520B-HF



SS54B-HF Thru. SS520B-HF

Reverse Voltage: 40 to 200 Volts

Forward Current: 5.0 Amp

RoHS Device

Halogen Free

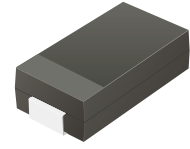

Features

- Metal silicon junction, majority carrier conduction.
- For surface mounted applications.
- Low power loss, high efficiency.
- High forward surge current capability.
- For use in low voltage, high frequency inverters, free wheeling, and polarity protection applications.

Mechanical data

- Case: SMB
- Terminals: Solderable per MIL-STD-750, method 2026.

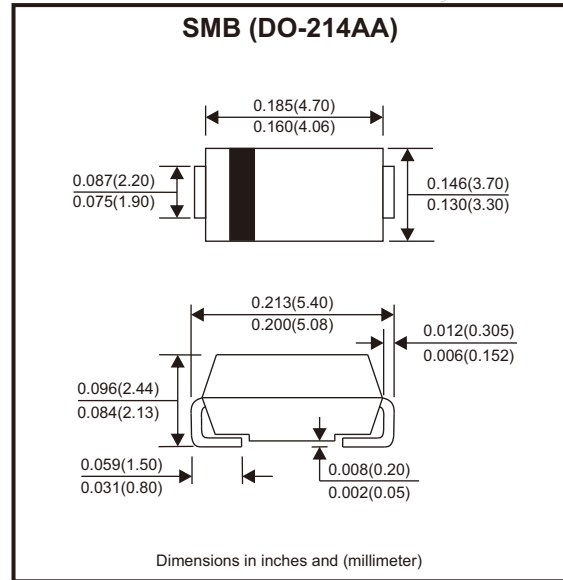

Circuit Diagram



Maximum Ratings and Electrical Characteristics

Ratings at 25°C ambient temperature unless otherwise specified.
Single phase, half wave, 60Hz resistive or inductive load, for capacitive load, derate by 20%

Parameter	Symbols	SS54B-HF	SS56B-HF	SS510B-HF	SS515B-HF	SS520B-HF	Units
Maximum repetitive peak reverse voltage	V_{RRM}	40	60	100	150	200	V
Maximum RMS voltage	V_{RMS}	28	42	70	105	140	V
Maximum DC blocking voltage	V_{DC}	40	60	100	150	200	V
Maximum average forward rectified current	$I_{F(AV)}$	5					A
Peak forward surge current, 8.3ms single half sine-wave superimposed on rated load (JEDEC method)	I_{FSM}	150					A
Max instantaneous forward voltage at 5A	V_F	0.55	0.70	0.85			V
Maximum DC reverse current $T_j = 25^\circ\text{C}$ at rated DC reverse voltage $T_j = 100^\circ\text{C}$	I_R	1.0 50	0.3 25				mA
Typical junction capacitance (Note 1)	C_j	500	300				pF
Typical thermal resistance (Note 2)	$R_{\theta JA}$	50					$^\circ\text{C/W}$
Operating junction temperature range	T_j	-55 ~ +150					$^\circ\text{C}$
Storage temperature range	T_{stg}	-55 ~ +150					$^\circ\text{C}$

Notes: 1. Measured at 1 MHz and applied reverse voltage of 4 V D.C
2. P.C.B. mounted with 2.0" X 2.0" (5 X 5 cm) copper pad areas.

Company reserves the right to improve product design , functions and reliability without notice.

REV:A

Rating and Characteristic Curves (SS54B-HF Thru. SS520B-HF)

Fig.1 - Forward Current Derating Curve

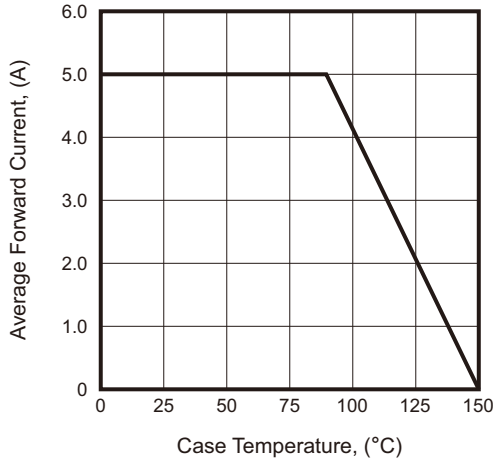

Fig.2 - Typical Reverse Characteristics

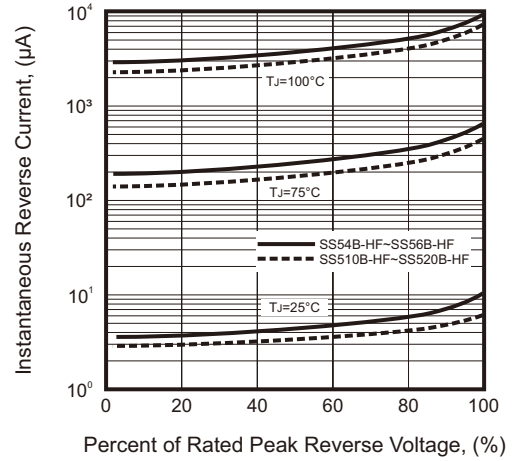

Fig.3 - Typical Forward Characteristic

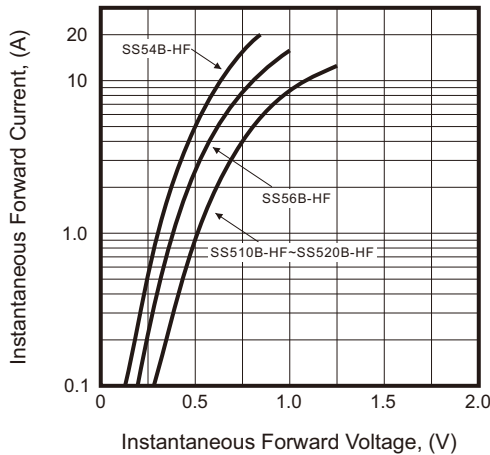

Fig.4 - Typical Junction Capacitance

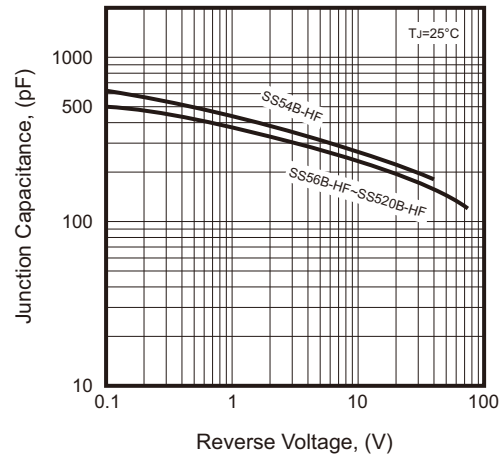

Fig.5 - Maximum Non-Repetitive Peak Forward Surge Current

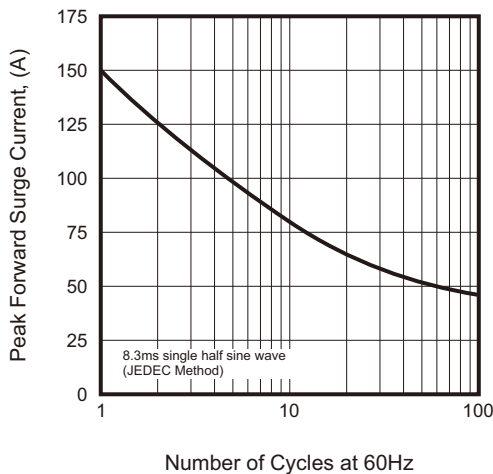
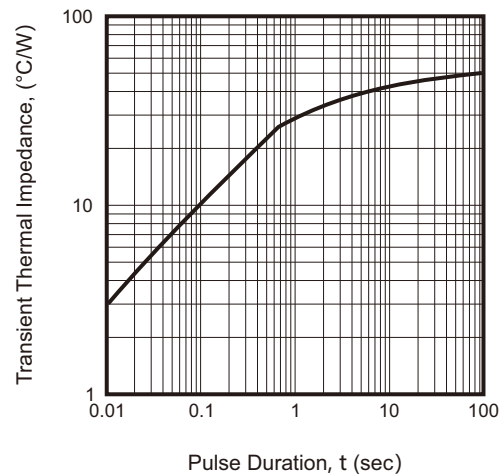
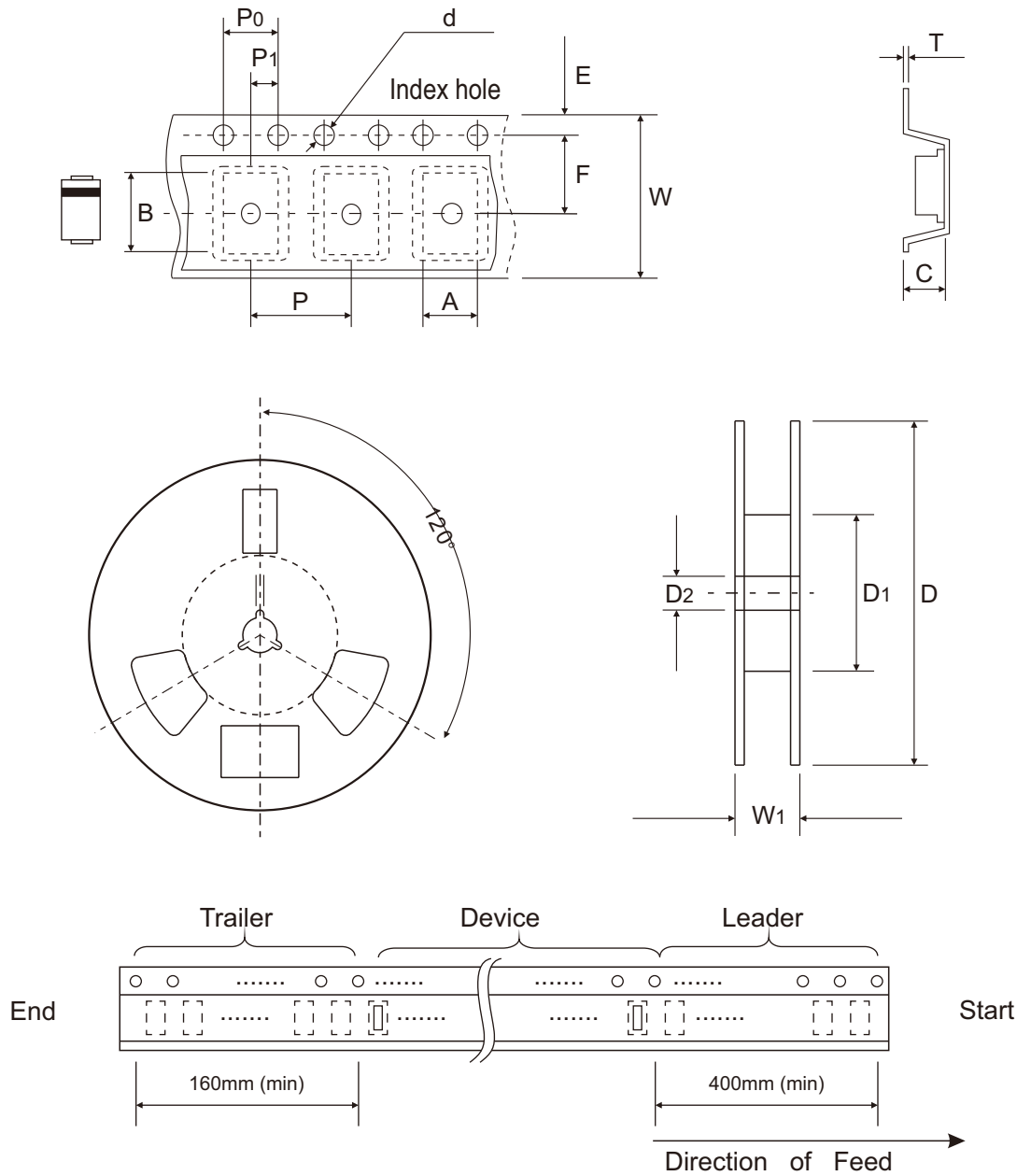

Fig.6 - Typical Transient Thermal Impedance



Company reserves the right to improve product design, functions and reliability without notice.

Reel Taping Specification



DO-214AA (SMB)	SYMBOL	A	B	C	d	D	D1	D2
	(mm)	3.80 ± 0.10	5.50 + 0.05 - 0.10	2.45 ± 0.05	1.55 ± 0.05	330 ± 2.00	100 ± 1.00	13.00 ± 0.20
	(inch)	0.150 ± 0.004	0.217 + 0.002 - 0.004	0.096 ± 0.002	0.061 ± 0.002	12.992 ± 0.079	3.937 ± 0.039	0.512 ± 0.008

DO-214AA (SMB)	SYMBOL	E	F	P	P0	P1	T	W	W1
	(mm)	1.75 ± 0.10	5.50 ± 0.05	8.00 ± 0.10	4.00 ± 0.10	2.00 ± 0.05	0.25 ± 0.05	12.00 ± 0.15	18.00 + 2.00 - 1.00
	(inch)	0.069 ± 0.004	0.217 ± 0.002	0.315 ± 0.004	0.157 ± 0.004	0.079 ± 0.002	0.010 ± 0.002	0.472 ± 0.006	0.709 + 0.079 - 0.039

Company reserves the right to improve product design , functions and reliability without notice.

REV:A

Marking Code

Part Number	Marking Code
SS54B-HF	SS54
SS56B-HF	SS56
SS510B-HF	SS510
SS515B-HF	SS515
SS520B-HF	SS520

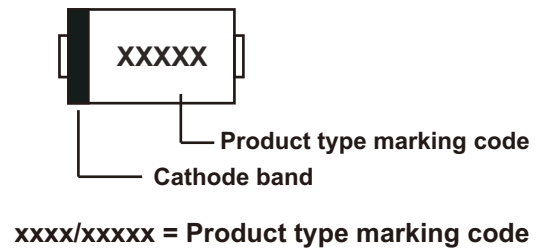

Suggested PAD Layout

SIZE	DO-214AA (SMB)	
	(mm)	(inch)
A	2.20	0.087
B	2.40	0.094
C	2.80	0.110
D	7.00	0.276

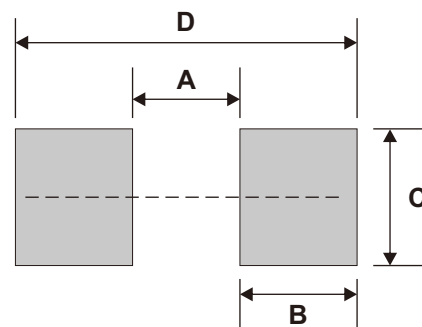

Note: 1. The pad layout is for reference purpose only.

Standard Packaging

Case Type	REEL PACK	
	REEL (pcs)	Reel Size (inch)
DO-214AA (SMB)	3,000	13

Looking for pricing, stock, or lifecycle information?

Click below to explore more details on WIN SOURCE:

- [View SS520B-HF on WIN SOURCE](#)
- [Comchip Technology Information](#)

Optimize Your Supply Chain with WIN SOURCE Solutions

- ✓ Global Sourcing Solution
- ✓ Obsolete Management
- ✓ Cost Control Management
- ✓ Shortage Management
- ✓ Alternative Solution
- ✓ Excess Inventory Management