



**THE DATASHEET OF  
MA310.A.LB.001**





# TAOGLAS®



## Datasheet

MA310.A.LB.001

**Description:**

Magnet Mount GPS/GLONASS 4G LTE/Cellular

**Features:**

1\*LTE Antenna

1\*Active GNSS Antenna - GPS L1 and GLONASS L1

Magnet Mount

IP67 Enclosure

Dimension:  $\phi$ 77mm x 23mm

LTE: 3M RG-174 Cable and SMA(M)ST Connector

GNSS: 3M RG-174 Cable and SMA(M)ST Connector

Custom Cables and Connectors Available

RoHS & REACH Compliant

1. Introduction	3
2. Specifications	4
3. Antenna Characteristics	6
4. Antenna Radiation Patterns	13
5. Mechanical Drawing	24
6. Packaging	25
7. Application Note	26

Taoglas makes no warranties based on the accuracy or completeness of the contents of this document and reserves the right to make changes to specifications and product descriptions at any time without notice. Taoglas reserves all rights to this document and the information contained herein.

Reproduction, use or disclosure to third parties without express permission is strictly prohibited.

Copyright © Taoglas Ltd.



# 1. Introduction



The MA310 antenna is a combination small form factor high performance GPS/GLONASS and Penta-band Cellular (GSM/GPRS/CDMA/ PCS/DCS/ WCDMA/UMTS) antenna to simplify AVL or Fleet management antenna systems worldwide.

It comes with magnetic mount as standard. An internal O-ring meets stringent IP-67 waterproof standards. With the strongest GPS/GLONASS and Cellular antenna design team in the industry and rigorous testing Taoglas offers guaranteed performance with your system and your environment.

The standard version comes with 3 metres RG174 cable and SMA(M) connectors for both GPS/GLONASS and Cellular feeds. Cables and connectors are customizable upon requests.

## Features

### GPS/GLONASS

- High LNA Gain up to 31 dB
- Antenna Gain  $28 \pm 2$  dB
- Miniaturized to 56.2 x 16.8 mm
- Low Noise Figure 2.8 dB typ. for GPS
- 3.2 dB typ. for GLONASS
- Ultra-Low Power Consumption 7~10mA typ. (at 3.3V DC)

### Cellular

- Advanced penta-band cellular antenna (GSM/GPRS/CDMA/PCS/DCS/WCDMA/UMTS/HSPA)
- GSM850: 824~896MHz,
- GSM900: 880~960MHz,
- DCS: 1710~1880MHz, DCS: 1850~1990MHz
- UMTS/WCDMA/HSPA:

### Other

- IP67 Water Resistant due to Internal O-Ring Structure
- Quality textured covert design.
- Low profile.
- ABS housing
- Optional cables and connectors
- ROHS Compliant

## 2. Specifications

LTE Antenna								
Frequency (MHz)		LTE700	GSM850	GSM900	DCS	PCS	UMTS1	LTE2600
		698~824	824~894	880~960	1710~1880	1850~1990	1920~2170	2490~2690
Efficiency (%)								
Free Space	0.3M	24.29	62.29	65.14	47.76	56.03	55.32	38.15
	1M	21.55	54.25	56.74	39.16	46.00	44.96	30.14
	2M	17.96	45.04	46.51	29.53	34.36	33.28	21.48
	3M	14.98	37.11	38.26	22.39	25.60	24.67	15.46
On 30x30cm Ground Plane	0.3M	35.33	52.72	40.18	58.35	54.95	50.97	45.37
	1M	31.36	45.92	34.99	47.80	45.13	41.43	35.49
	2M	26.16	38.14	28.71	36.08	33.71	30.68	25.28
	3M	21.84	31.47	23.61	27.36	25.12	22.74	17.94
Average Gain (dB)								
Free Space	0.3M	-6.15	-2.06	-1.86	-3.21	-2.52	-2.57	-4.19
	1M	-6.67	-2.66	-2.46	-4.07	-3.37	-3.47	-5.21
	2M	-7.46	-3.46	-3.32	-5.30	-4.64	-4.78	-6.68
	3M	-8.24	-4.30	-4.17	-6.50	-5.92	-6.08	-8.11
On 30x30cm Ground Plane	0.3M	-4.52	-2.78	-3.96	-2.34	-2.60	-2.93	-3.43
	1M	-5.04	-3.38	-4.56	-3.21	-3.46	-3.83	-4.50
	2M	-5.82	-4.19	-5.42	-4.43	-4.72	-5.13	-5.97
	3M	-6.61	-5.02	-6.27	-5.63	-6.00	-6.43	-7.46
Peak Gain (dBi)								
Free Space	0.3M	-4.11	-1.24	-1.41	-2.63	-2.01	-2.01	-2.89
	1M	-4.71	-1.84	-2.01	-3.43	-2.91	-2.91	-3.89
	2M	-5.51	-2.64	-2.81	-4.73	-4.21	-4.21	-5.29
	3M	-6.31	-3.54	-3.71	-5.93	-5.51	-5.51	-6.69
On 30x30cm Ground Plane	0.3M	-3.23	-2.53	-2.91	-1.92	-2.40	-2.40	-3.06
	1M	-3.83	-3.13	-3.51	-2.72	-3.30	-3.30	-4.06
	2M	-4.63	-3.93	-4.31	-3.92	-4.60	-4.60	-5.56
	3M	-5.43	-4.76	-5.21	-5.22	-5.81	-5.90	-7.06
Impedance	50 $\Omega$							
Return loss	< -3 dB							
Polarization	Vertical							

## GNSS Electrical

Frequency	GPS L1: 1575.42 MHz $\pm$ 1.023 MHz GLONASS L1: 1602 MHz $\pm$ 1.023 MHz		
Bandwidth - Return Loss <-10 dB	6 MHz min		
Return loss (GPS L1 GLONASS L1)	< -10 dB		
Passive Gain at Zenith (GPS L1 and GLONASS L1)	+1.0 dBic typ.		
Polarization	RHCP		
Impedance	50 $\Omega$		
LNA Out-band Attenuation	fo = 1575.42MHz fo $\pm$ 30 MHz 5dB Min. fo $\pm$ 50 MHz 20dB Min. fo $\pm$ 100 MHz 25dB Min.		
Input Voltage	Min:1.8V	Typ. 3.0V	Max: 5.5V
Total Gain @ Zenith	25dBic	27dBic	29dBic
Current Consumption	6mA	12mA	30mA
Noise Figure	3.5dB	3.5dB	3.7dB

## Mechanical

Dimensions	$\Phi$ 77*23mm		
Cable	LTE: 3000mm RG-174 GNSS: 3000mm RG-174		
Connector	LTE: SMA(M) GNSS: SMA(M)		
Casing	PC+ABS		
Adhesive	3M 9448HK + CR4305		
Sealant	Glue		
Weight	122g		

## Environmental

IP Rating	IP67		
Temperature Range	-40°C to +85°C		
Cable Pull	8 Kgf		
Magnetic Pull Force (Vertical)	1.5kgf/cm <sup>2</sup>		

## 3. Antenna Characteristics

### 3.1 LTE Antennas

#### 3.1.1. Return Loss – LTE

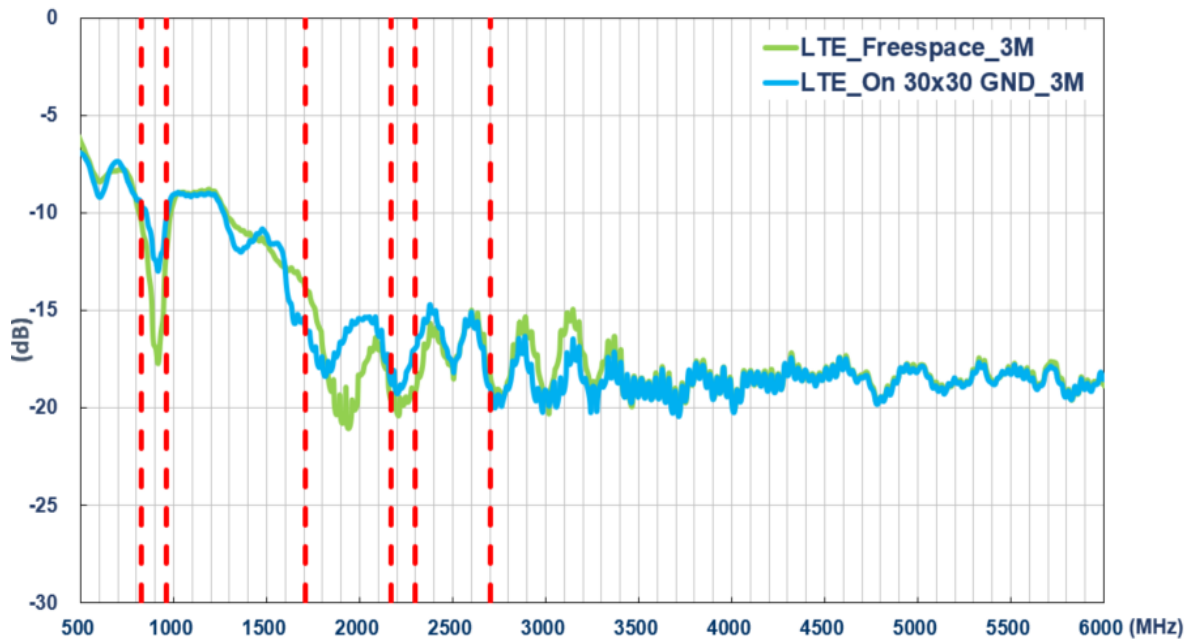

#### 3.1.2. Efficiency – LTE

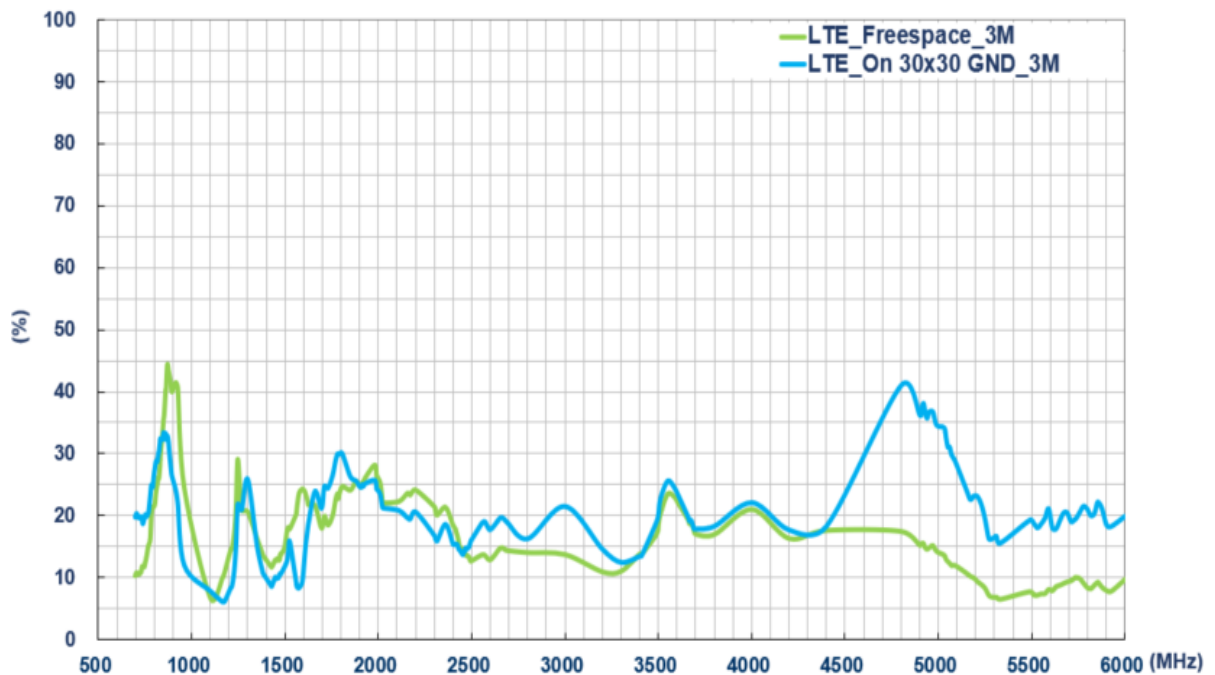

### 3.1.3. Average Gain – LTE

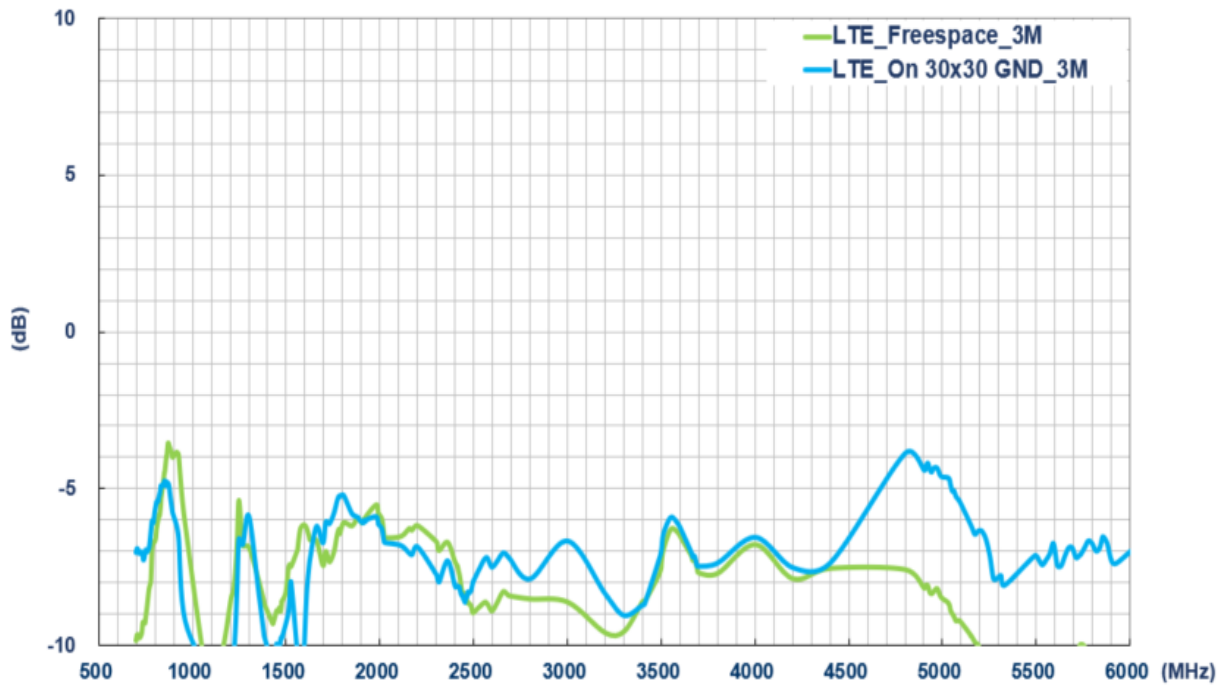

### 3.1.4. Peak Gain – LTE

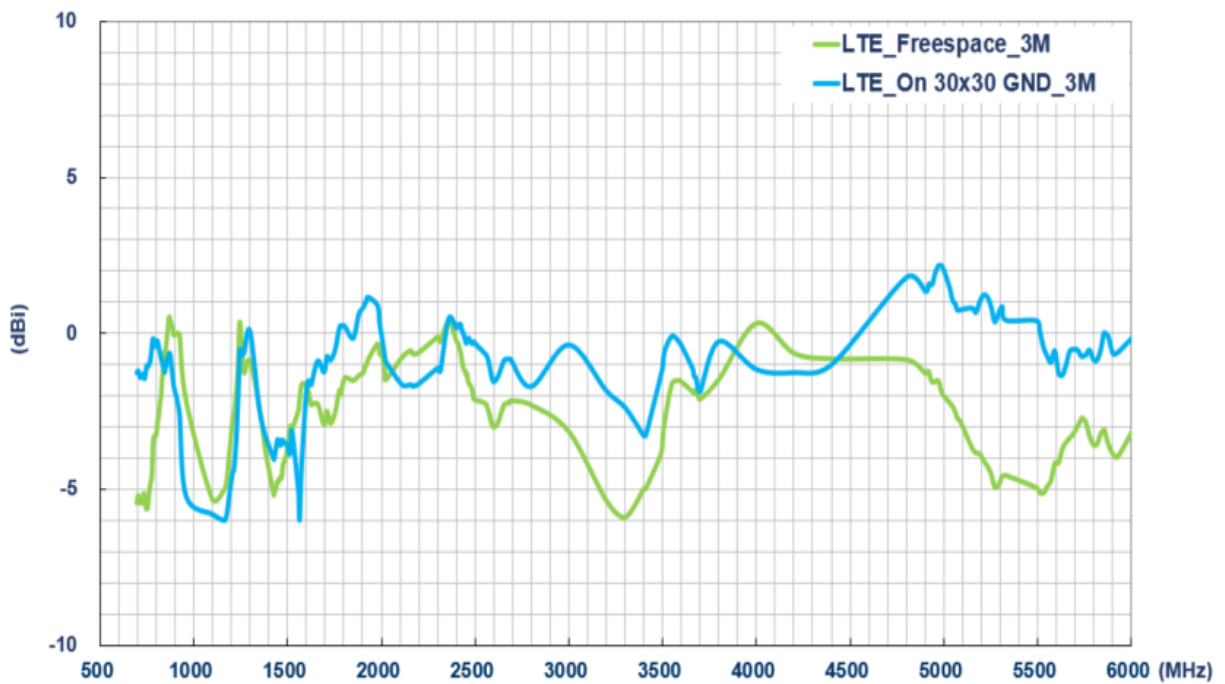

## 3.2 GNSS Antenna

### 3.2.1. Block Diagram (Active antenna)

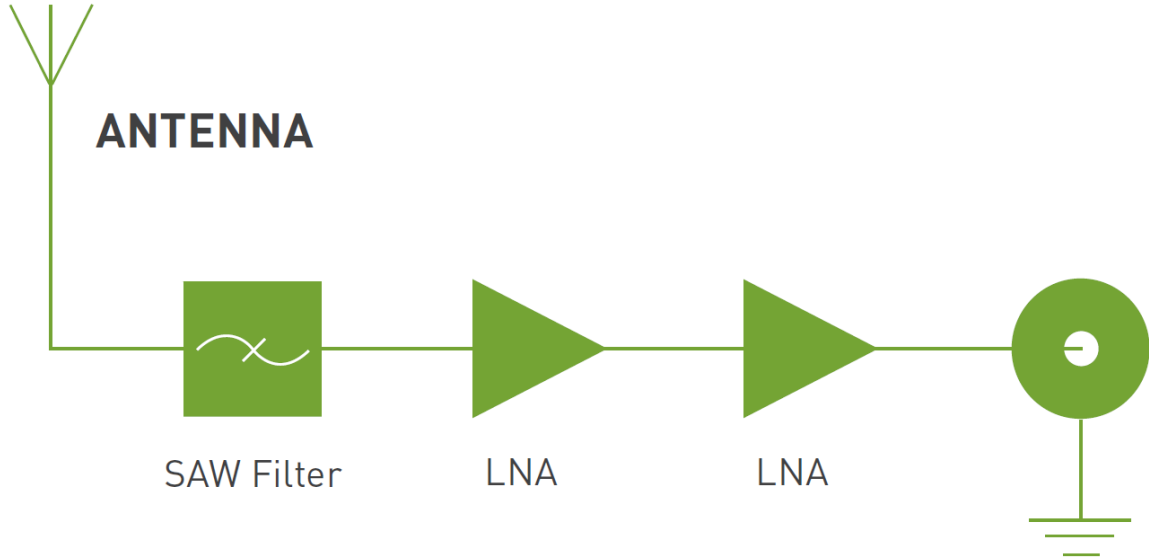

### 3.2.2. Return Loss – GNSS Antenna

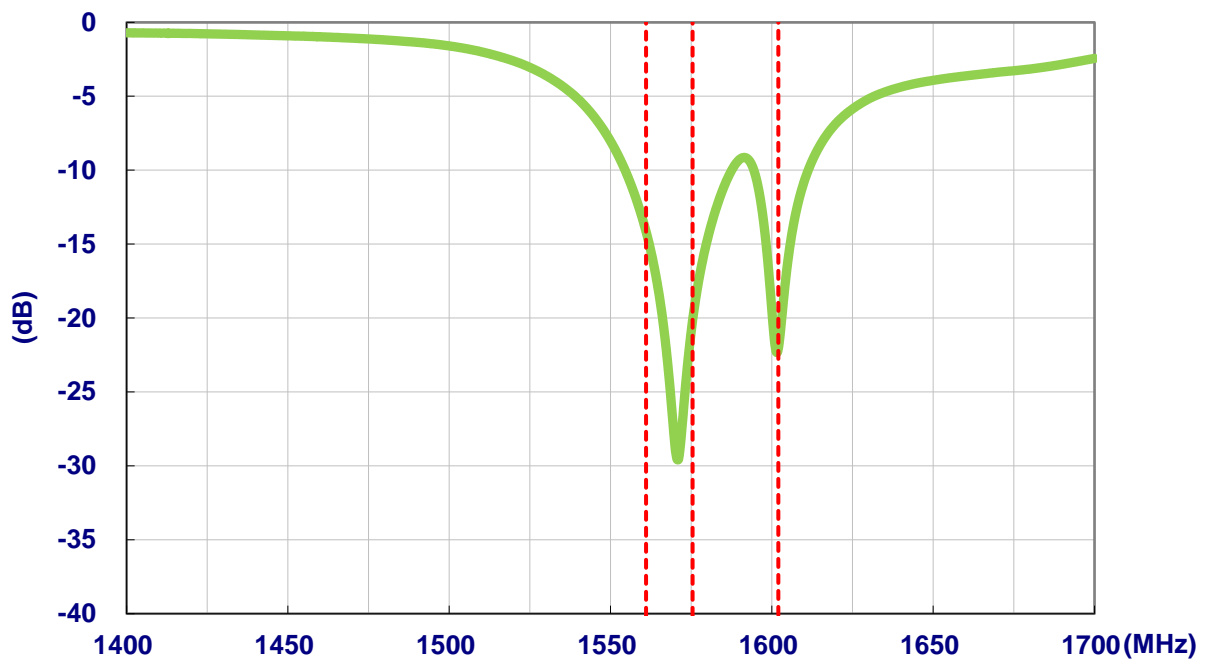

### 3.2.3. Impedance – GNSS Antenna

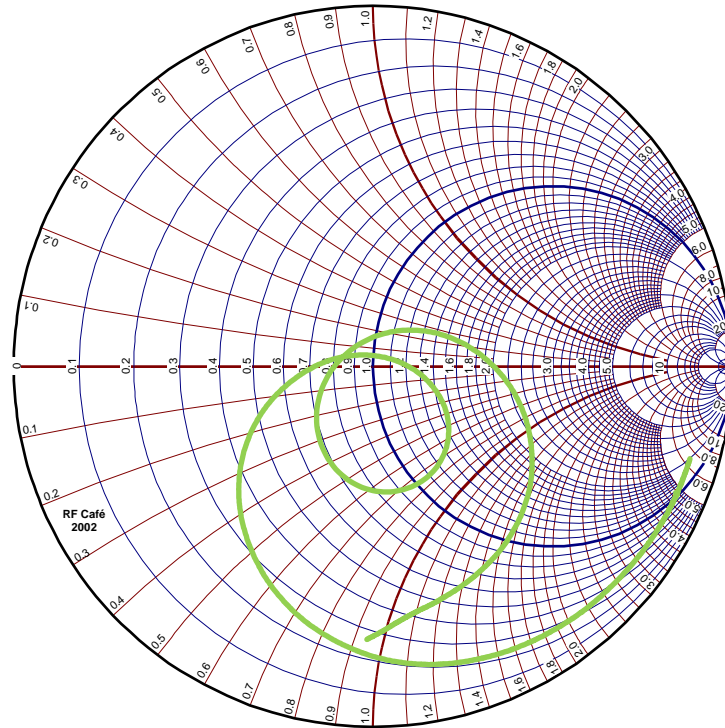

### 3.2.4. Efficiency – GNSS Antenna (passive measurement)

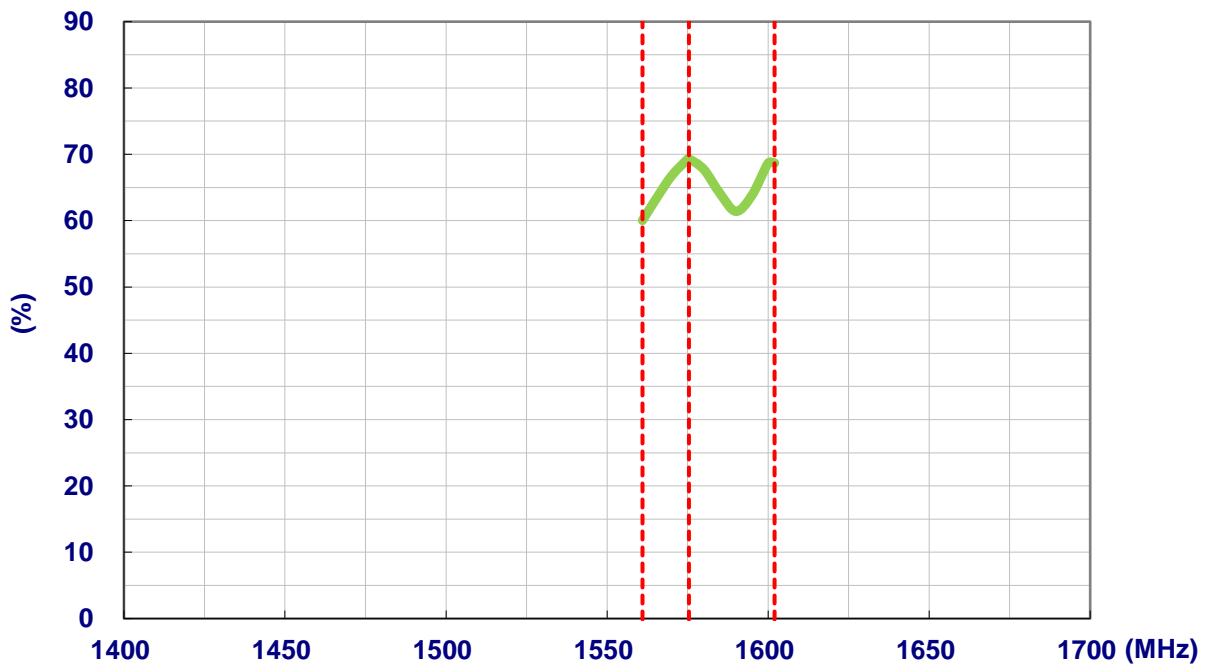

### 3.2.5. Average Gain – GNSS Antenna (passive measurement)

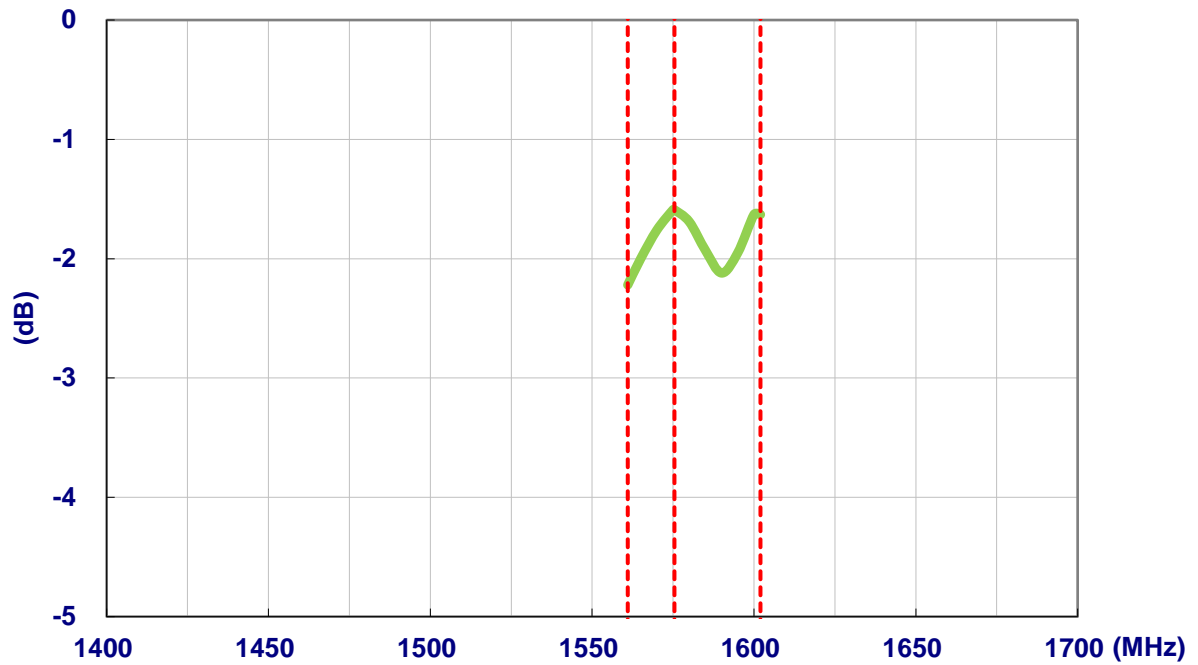

### 3.2.6. Peak Gain – GNSS Antenna (passive measurement)

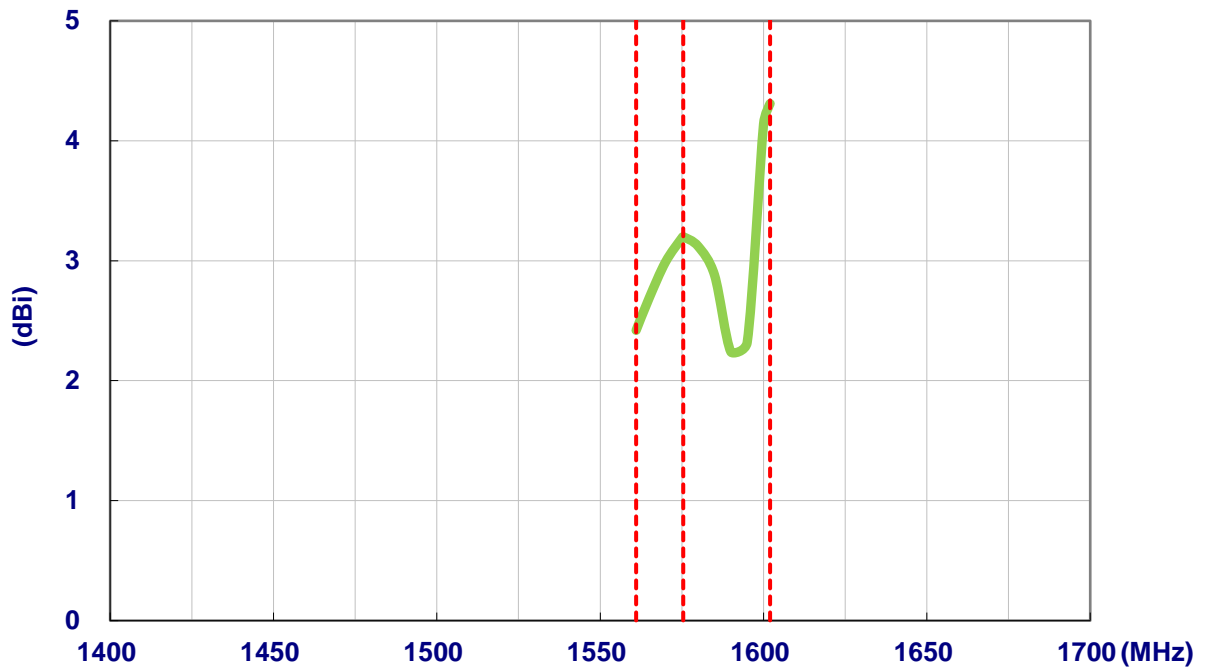

### 3.2.7. Axial Ratio – GNSS Antenna (Zenith is at 0°)

Axial Ratio at GPS L1 (1575.42 MHz)

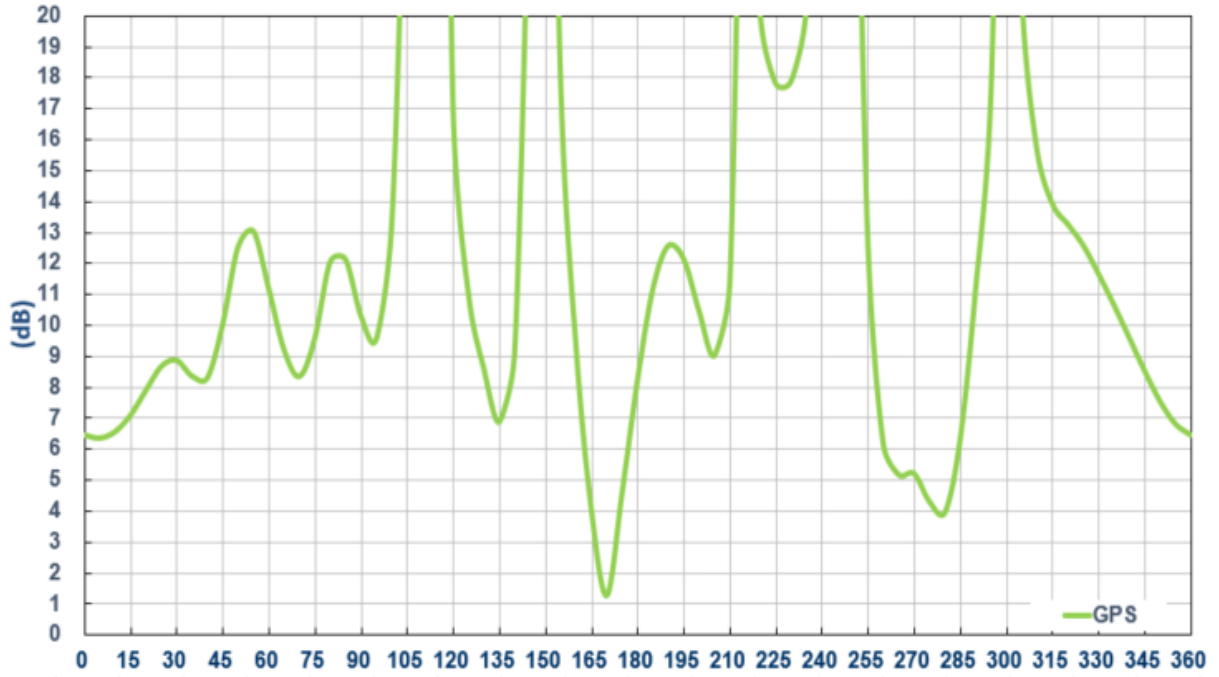

Axial Ratio at GLONASS L1 (1575.42 MHz)

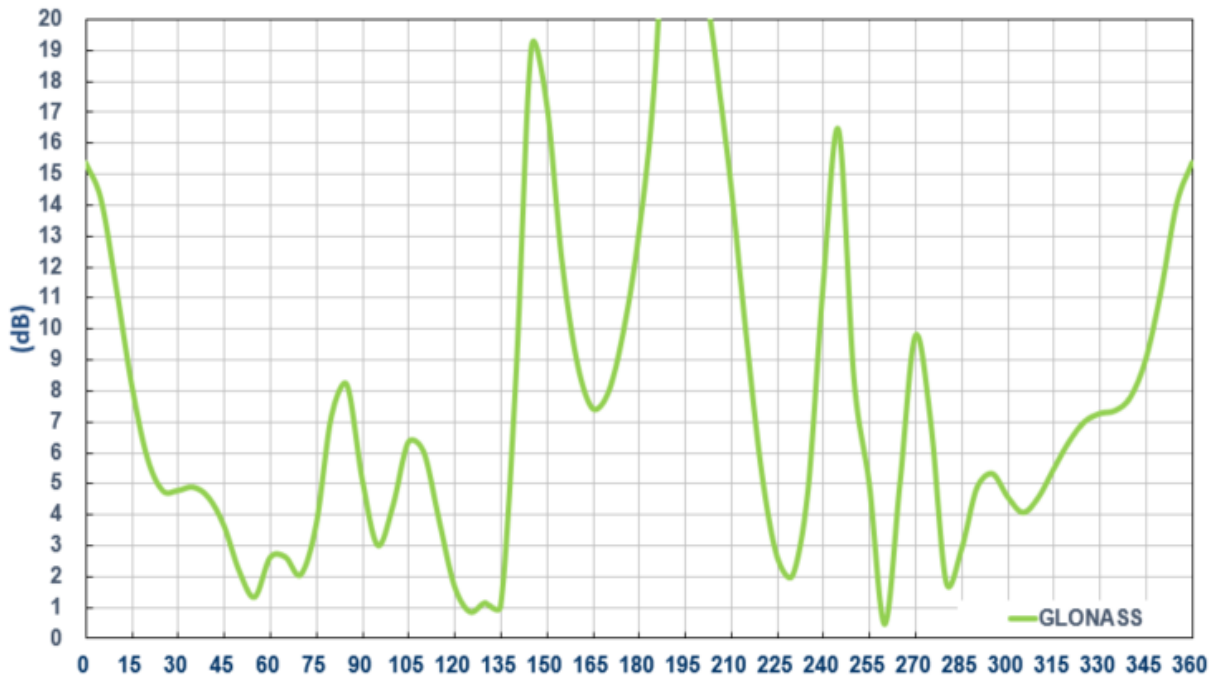

3.2.8. GNSS Antenna Active Measurements

LNA Gain @ 3.0V

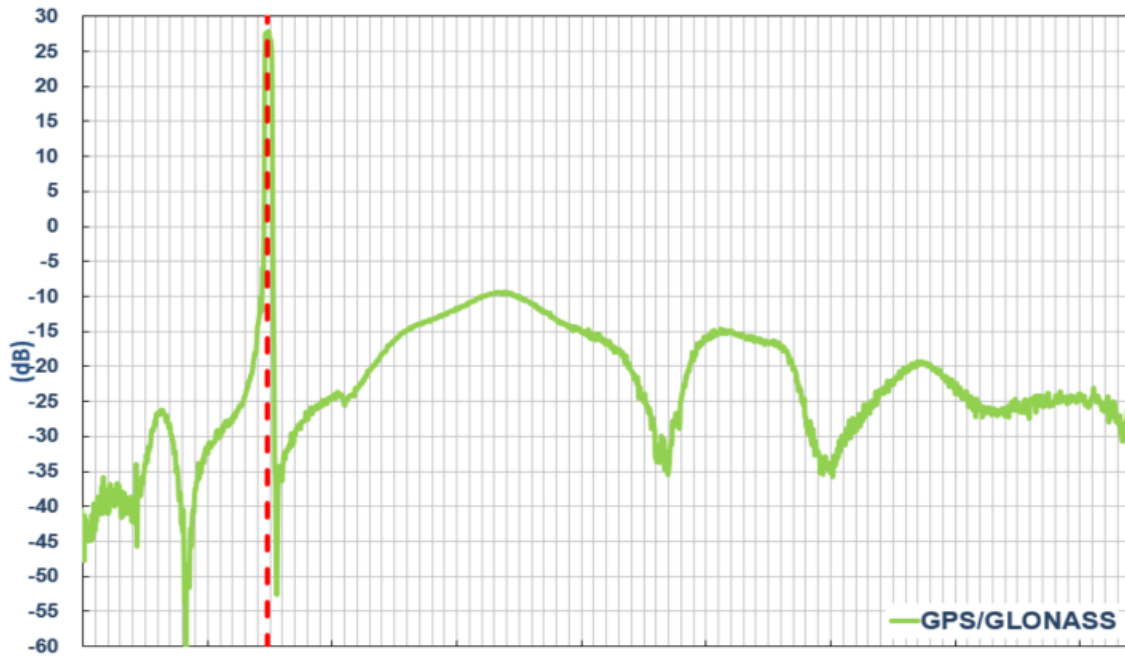

LNA Gain and Noise Figure @ 3.0V



## 4. Antenna Radiation Patterns

### 4.1 Test Setup



Free space

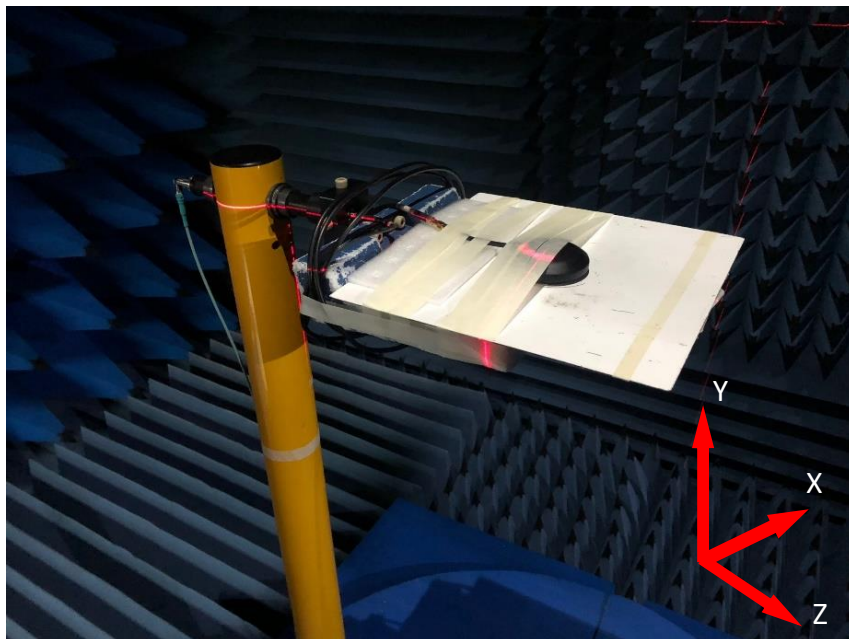

On 30\*30cm GND

## 4.2 2D Radiation Patterns

### 4.2.1. LTE\_Free Space

#### XY Plane

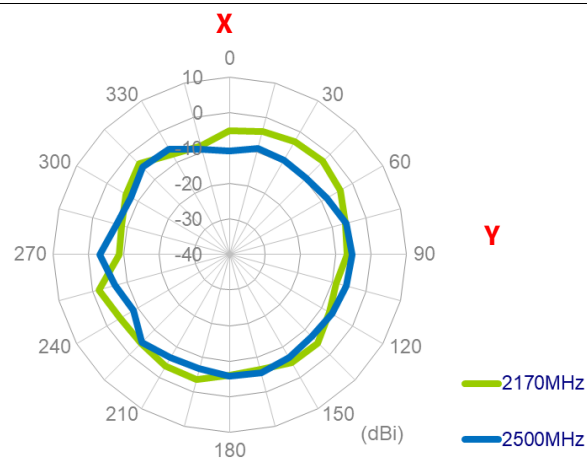
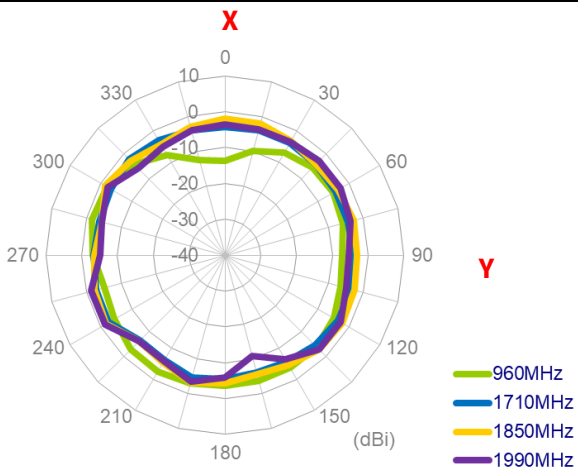
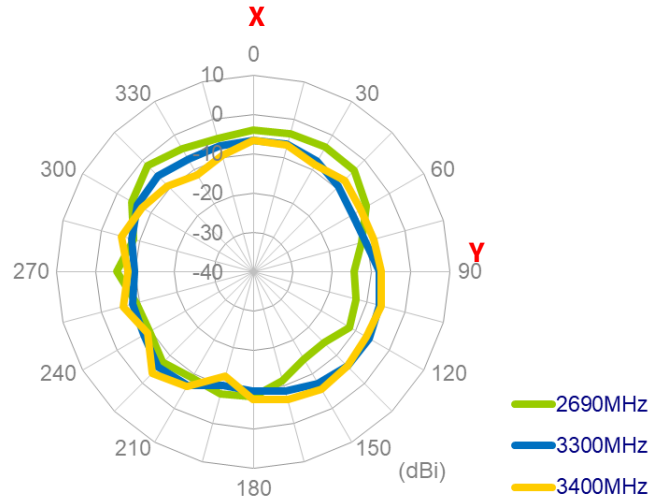
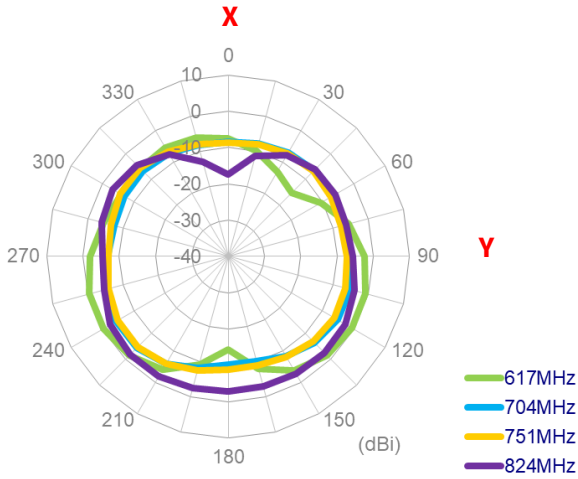

## XZ Plane

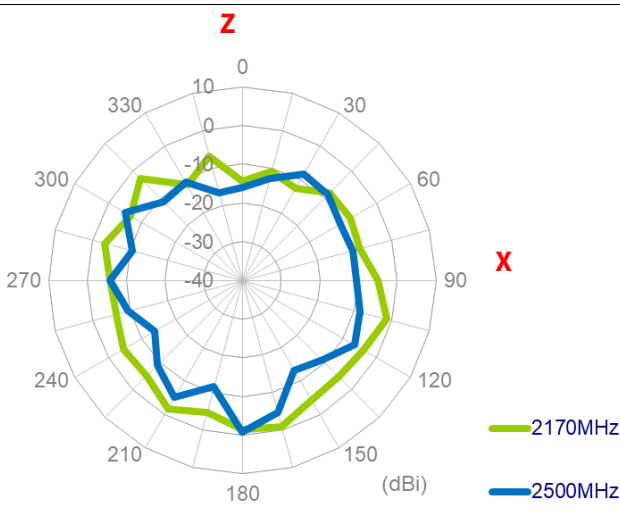
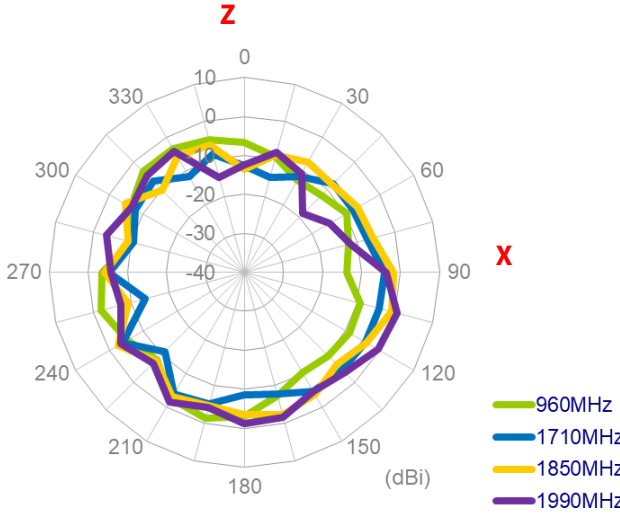
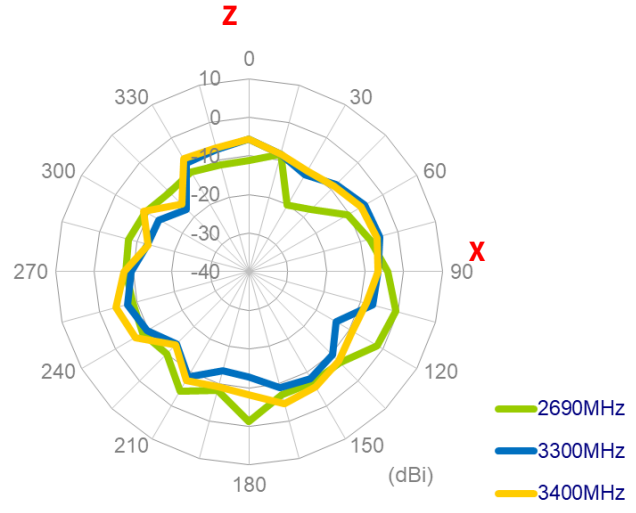
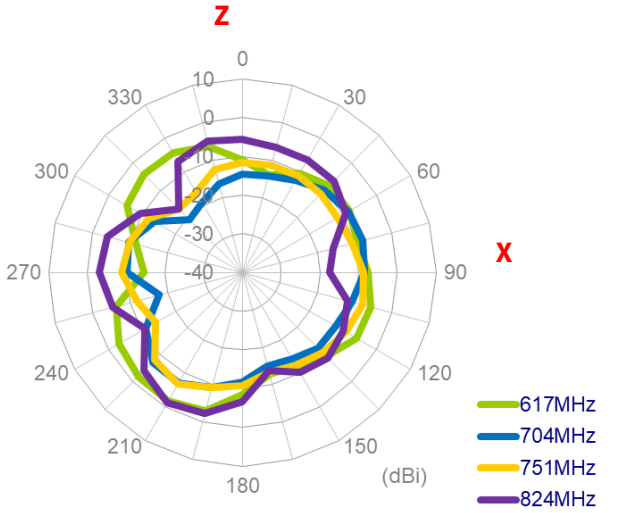

## YZ Plane

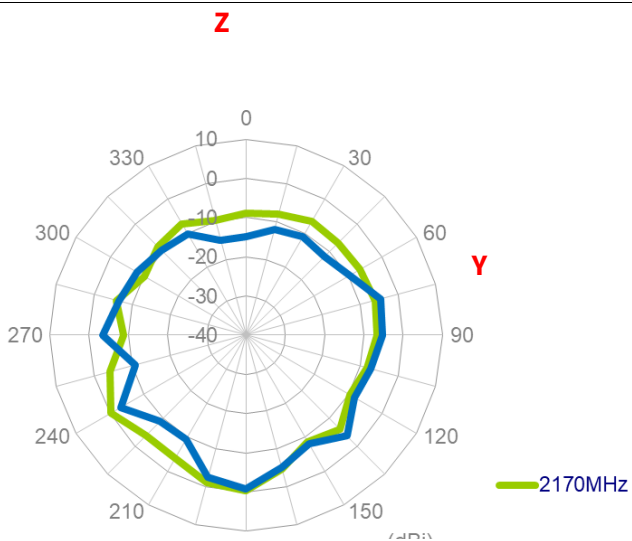
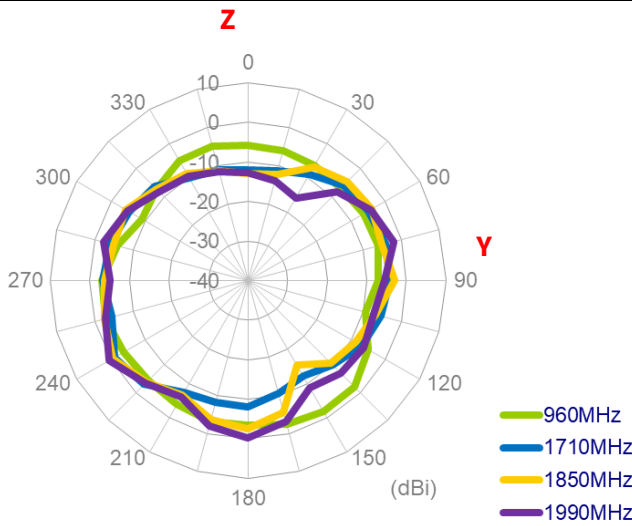
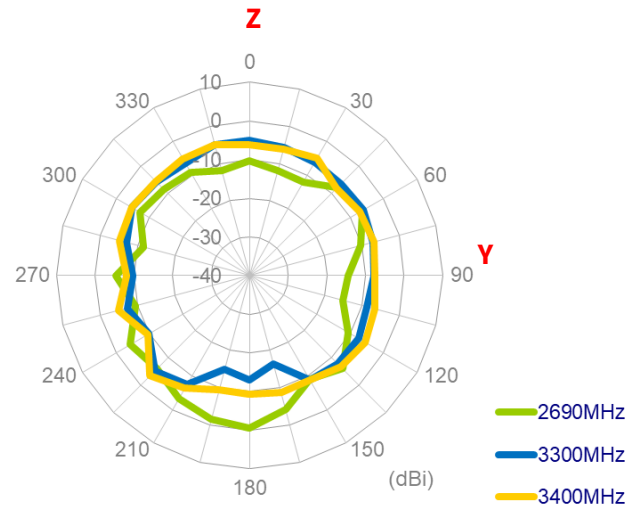
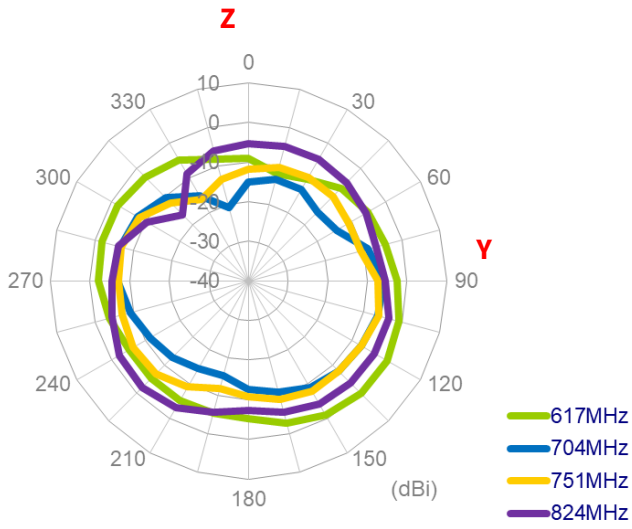

### 4.2.2. LTE\_On 30x30cm GND

#### XY Plane

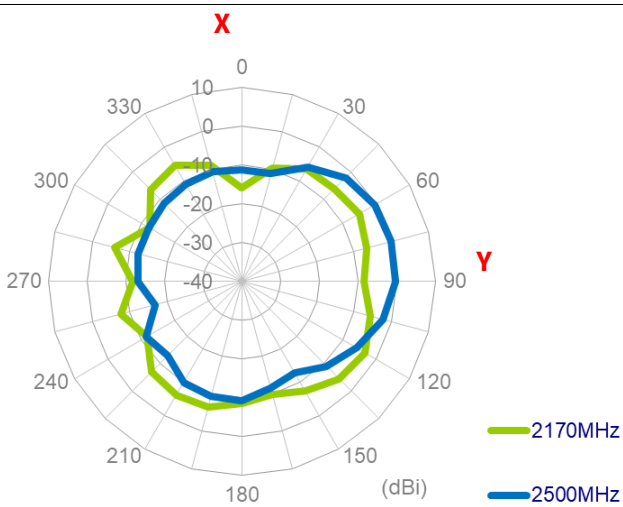
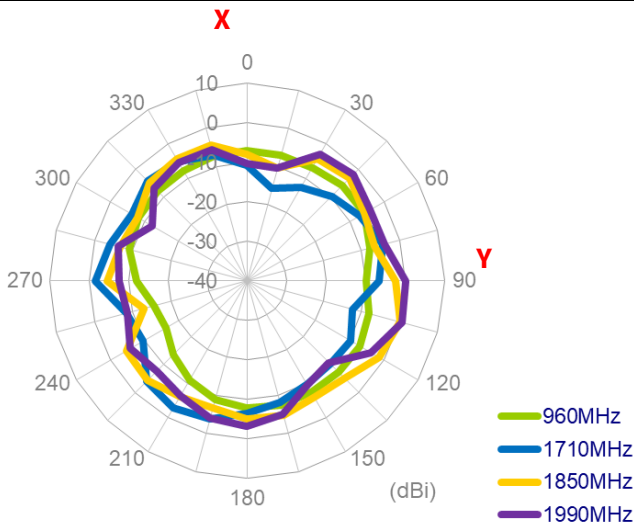
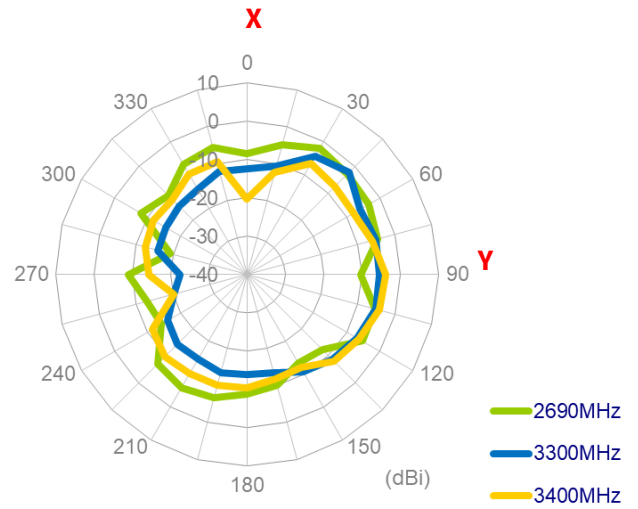
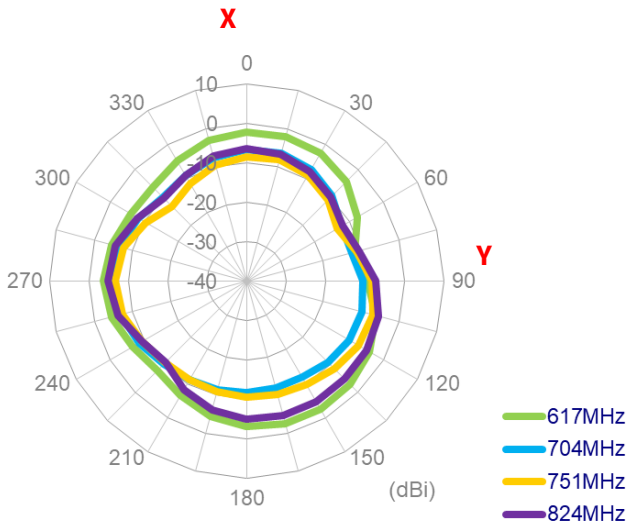

**XZ Plane**

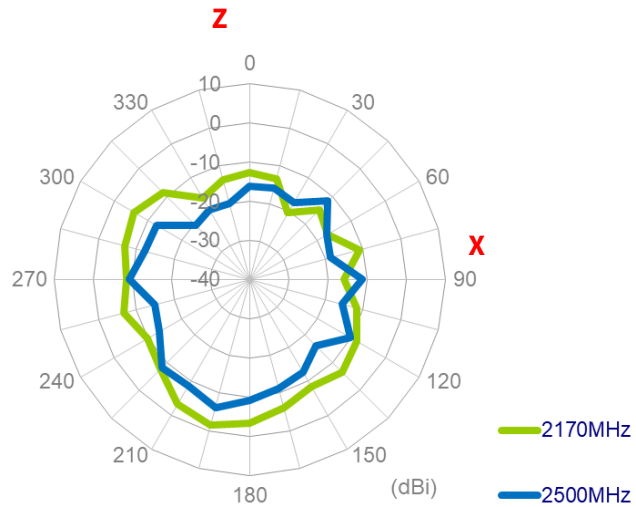
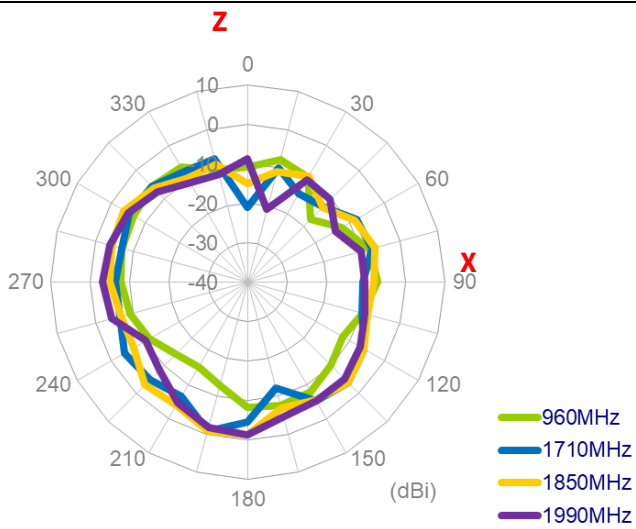
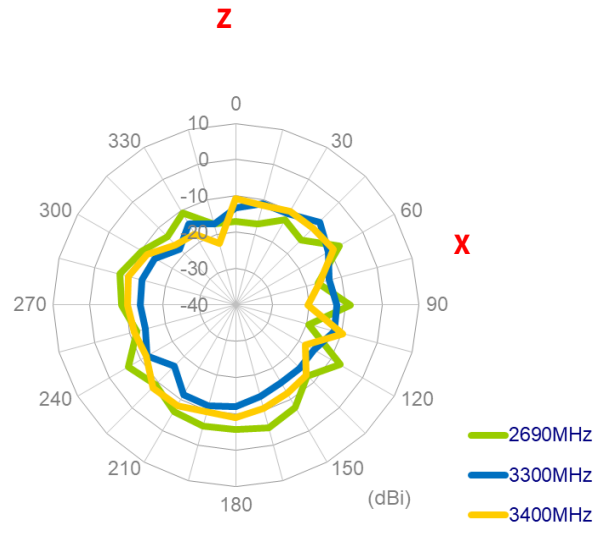
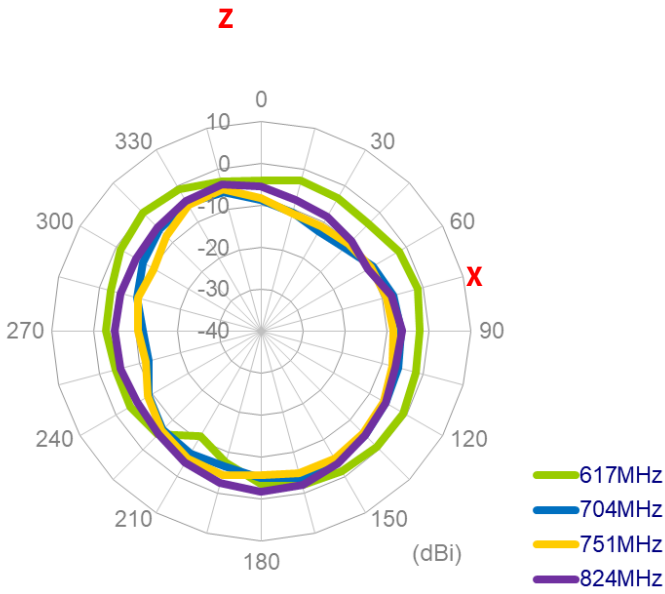

YZ Plane

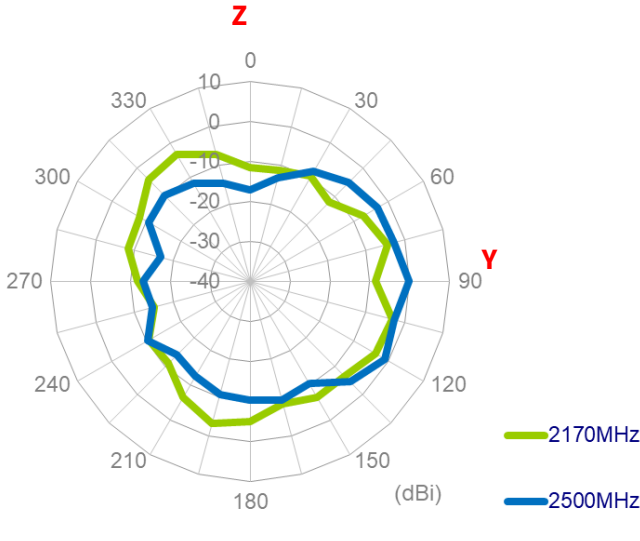
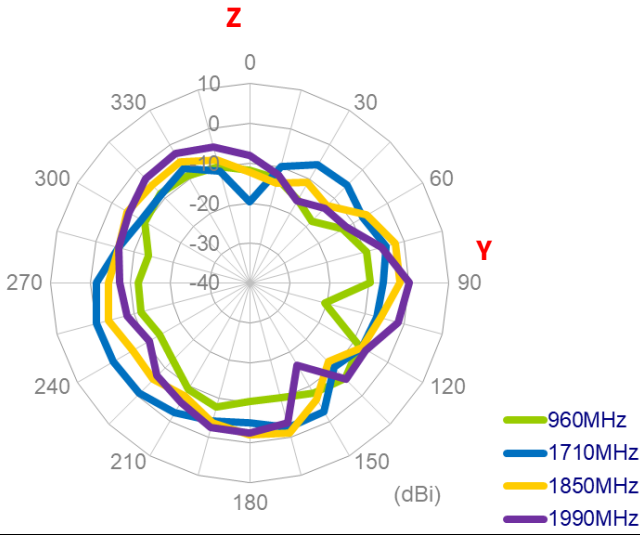
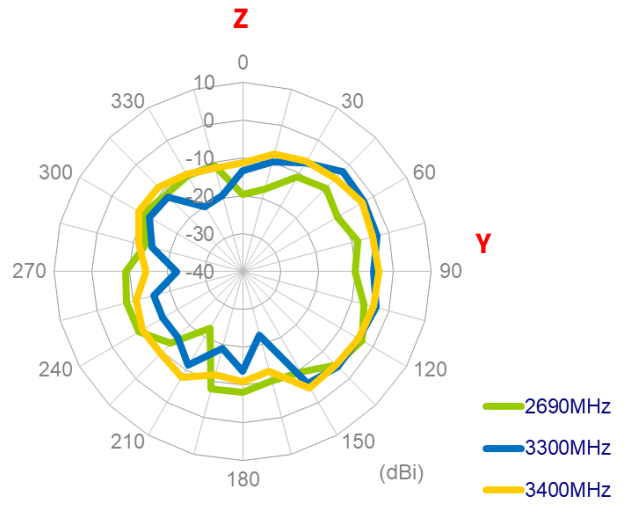
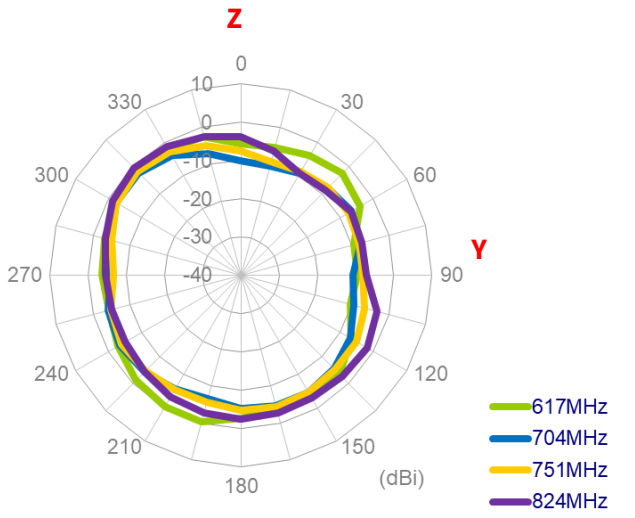

### 4.2.3. GNSS

#### XY Plane

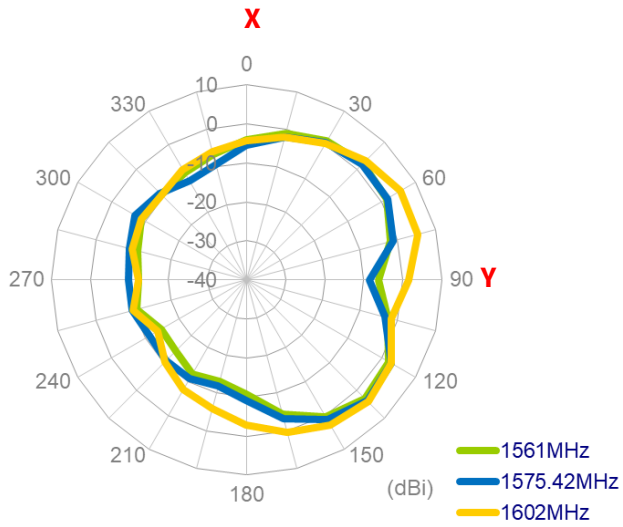

#### XZ Plane

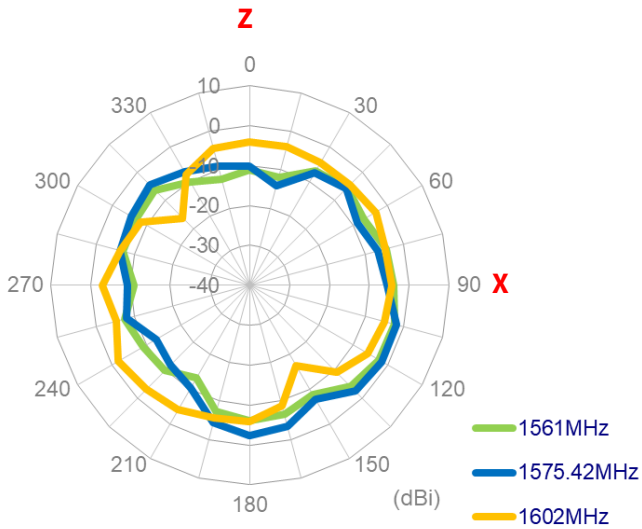

#### YZ Plane

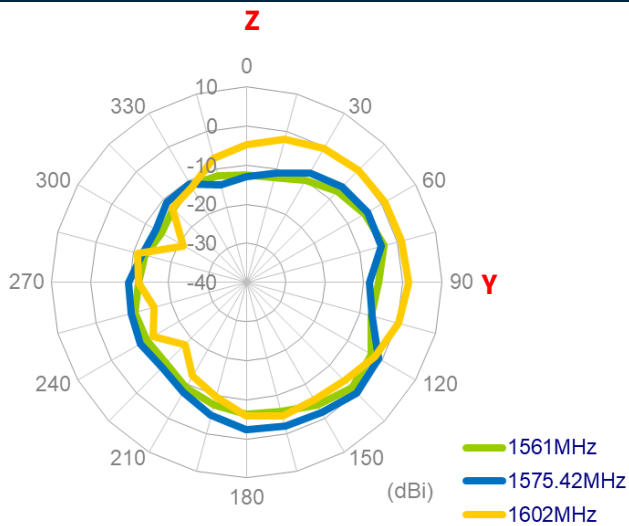

## 4.3 3D Radiation Patterns

### 4.3.1. LTE

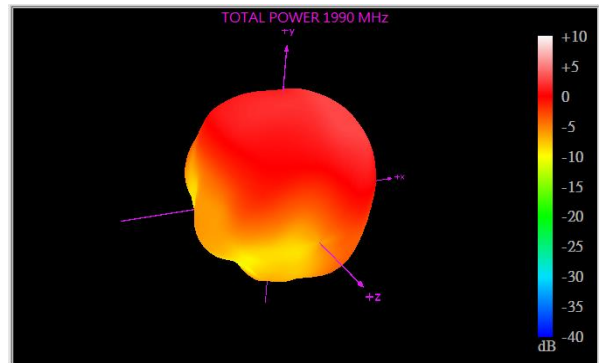
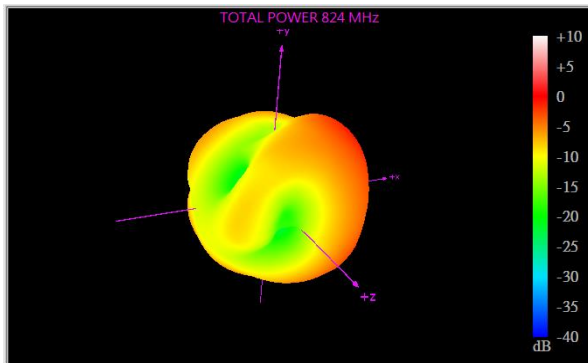
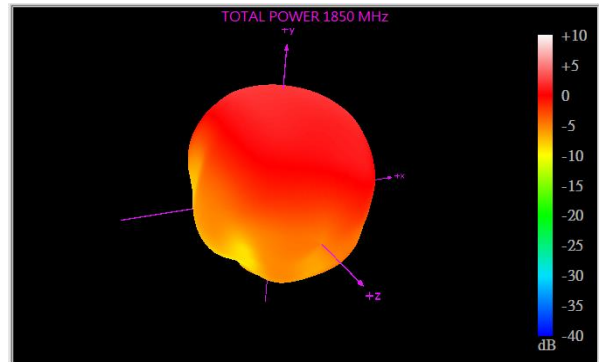
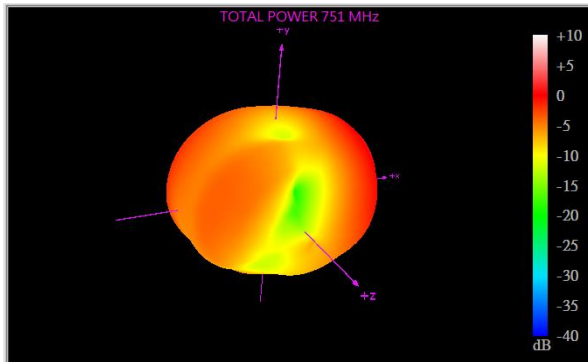
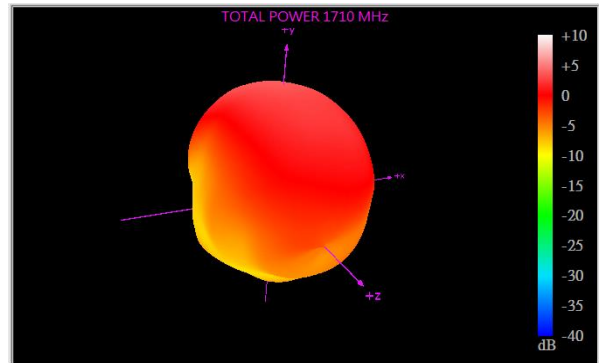
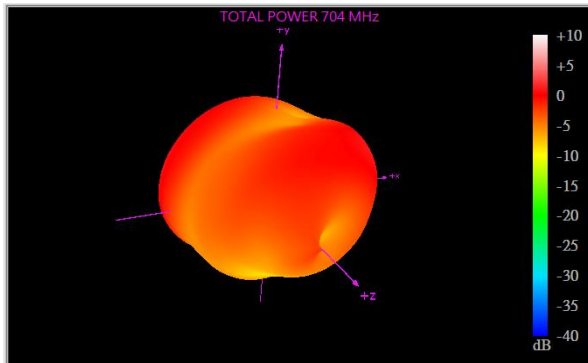
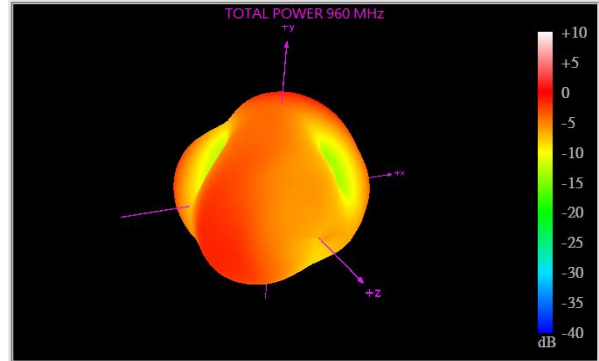
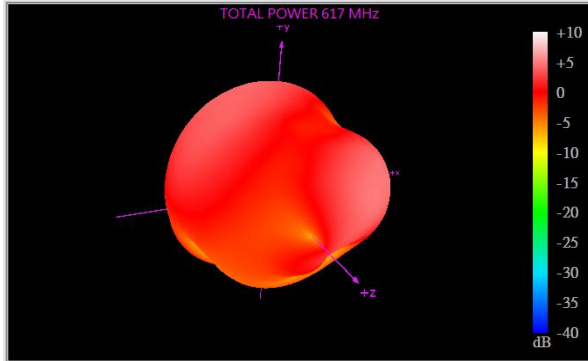

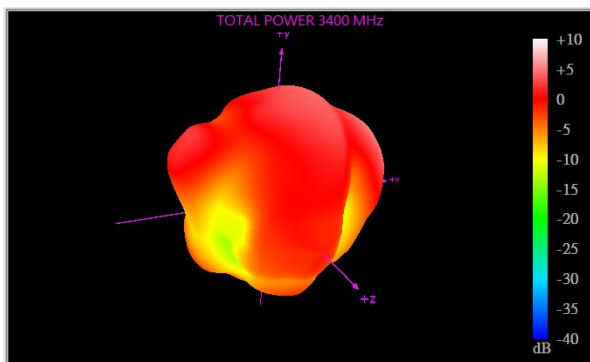
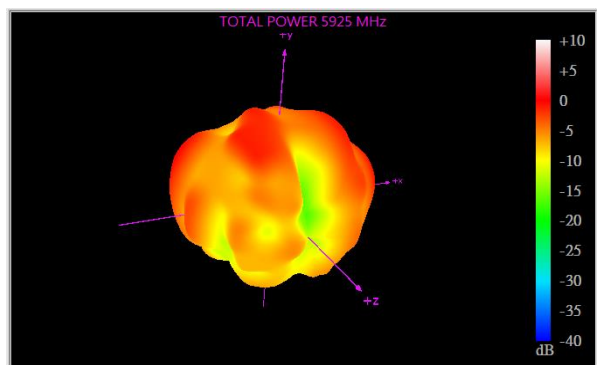
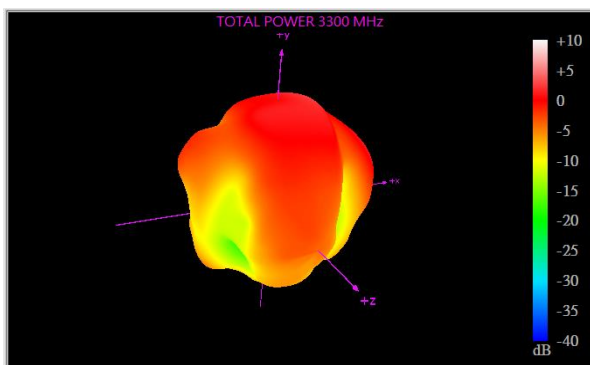
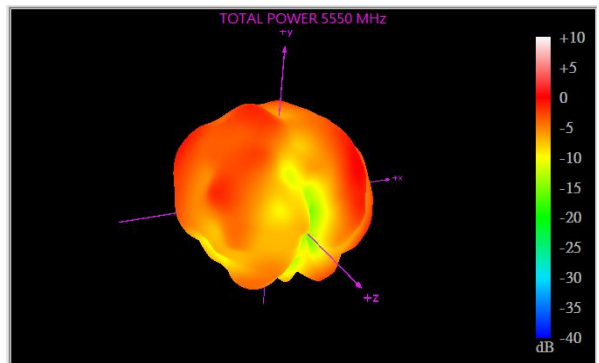
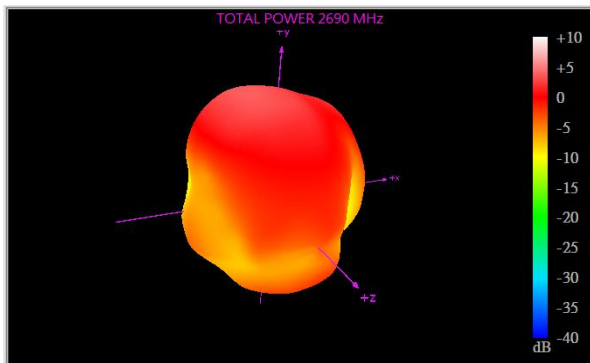
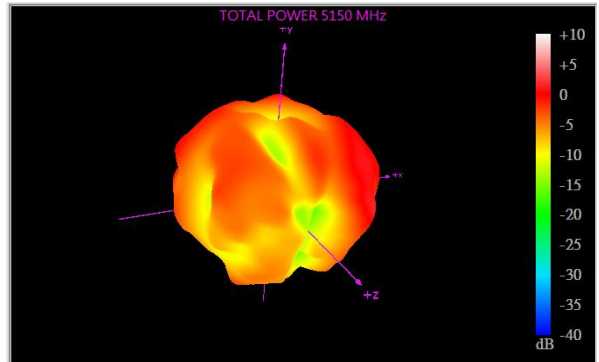
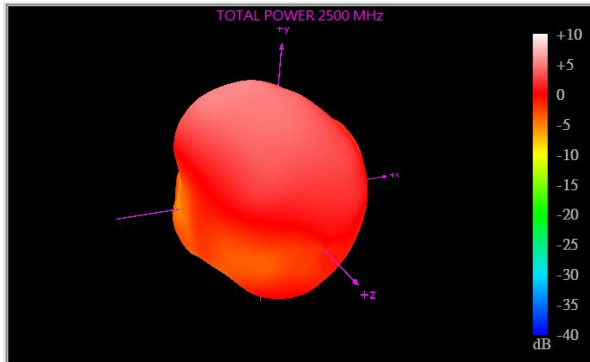
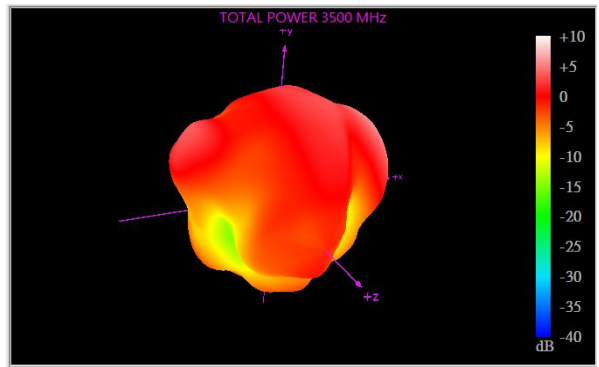
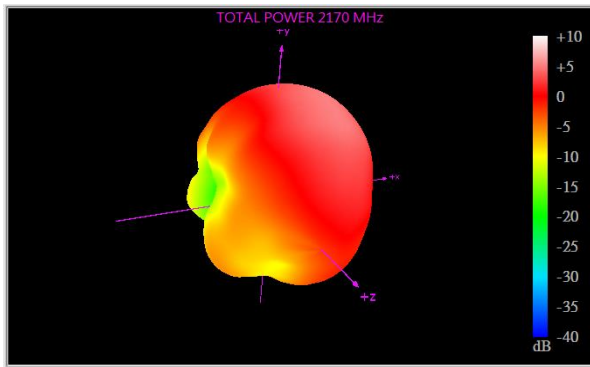

4.3.2. GNSS

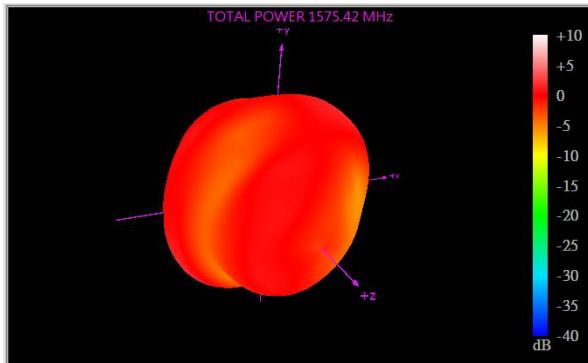
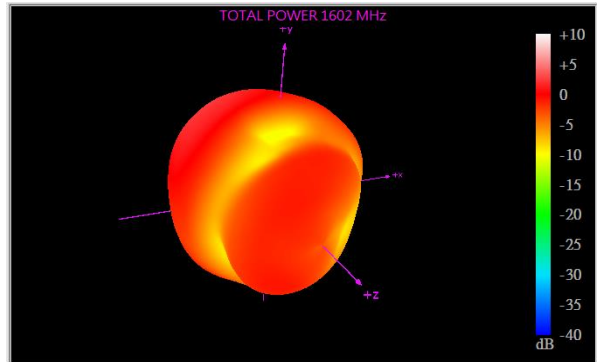
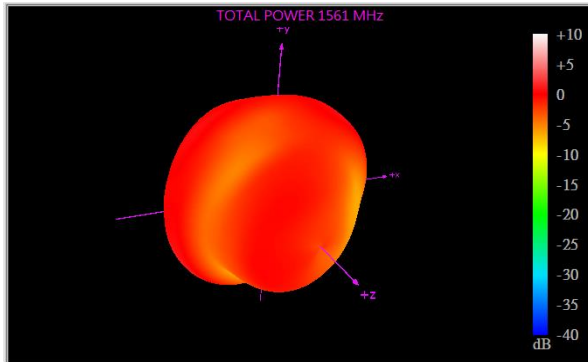

## 5. Mechanical Drawing (Units: mm)

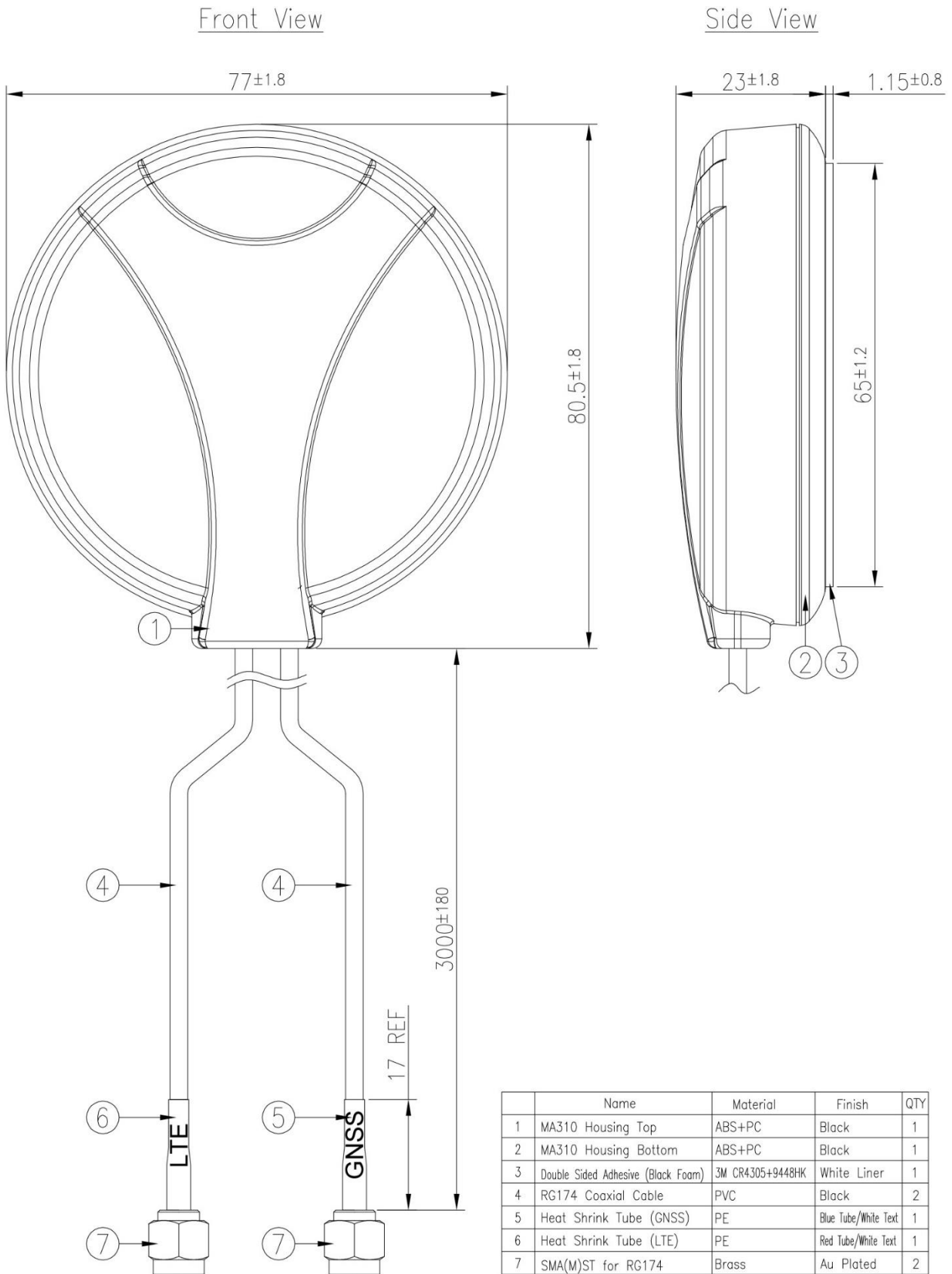

## 6. Packaging

1pc MA310.A.LB.001 per PE Bag  
 PE Bag Dimensions - 230\*180mm  
 Weight - 0.16Kg

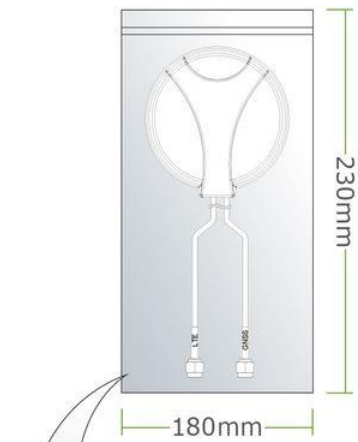

10 Large PE Bags per Carton  
 Box Dimensions - 480\*210\*210mm  
 Weight - 2.3Kg

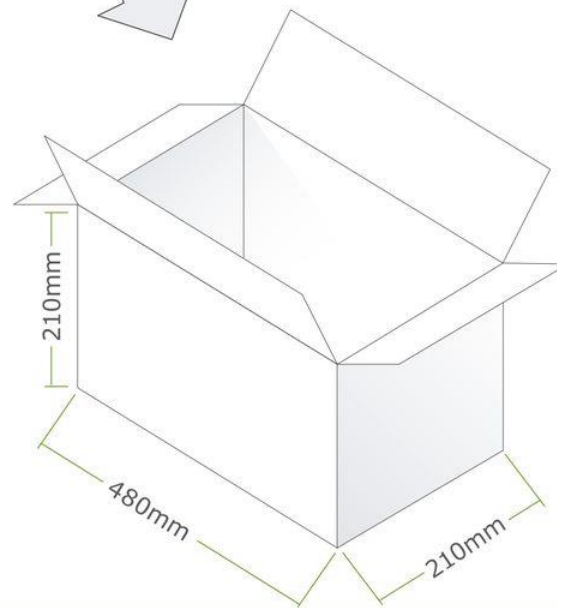

## 7. Application Note

The MA310.A.LB.001 antenna performance with different cable lengths is shown below.

### 7.1 Return Loss

Return Loss – LTE Antenna (Free Space)

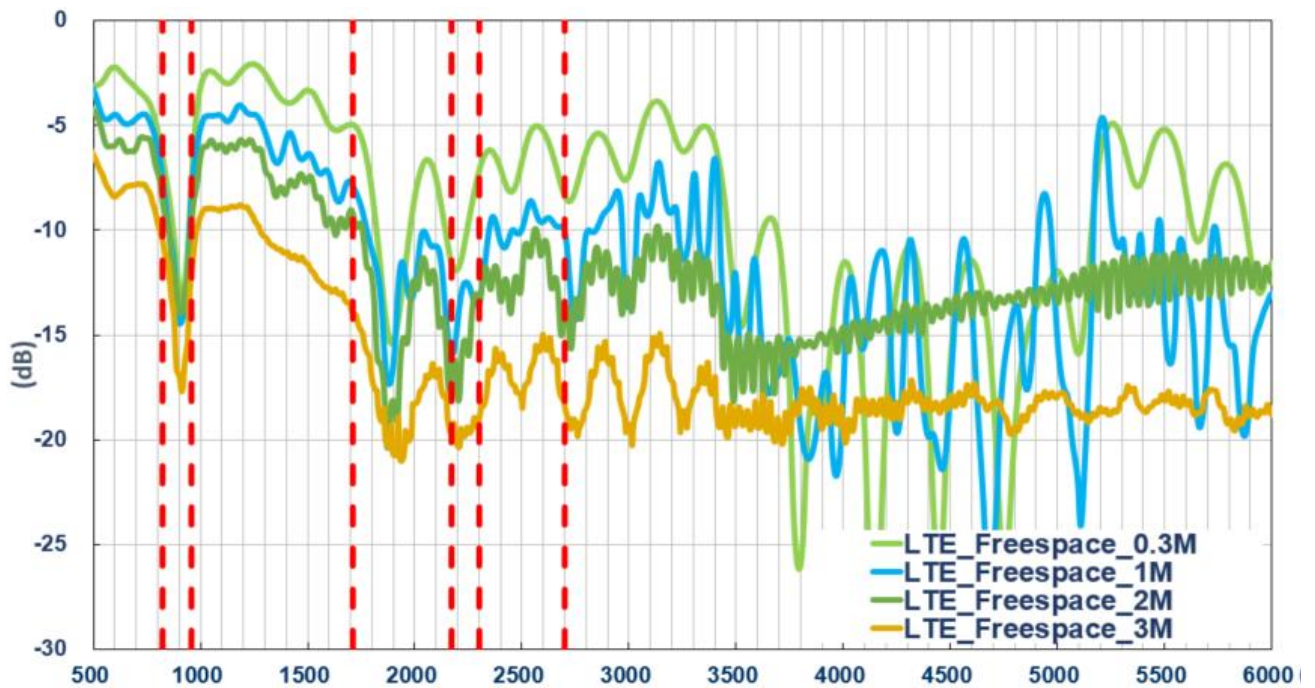

Return Loss – LTE Antenna (On 30\*30cm GND)

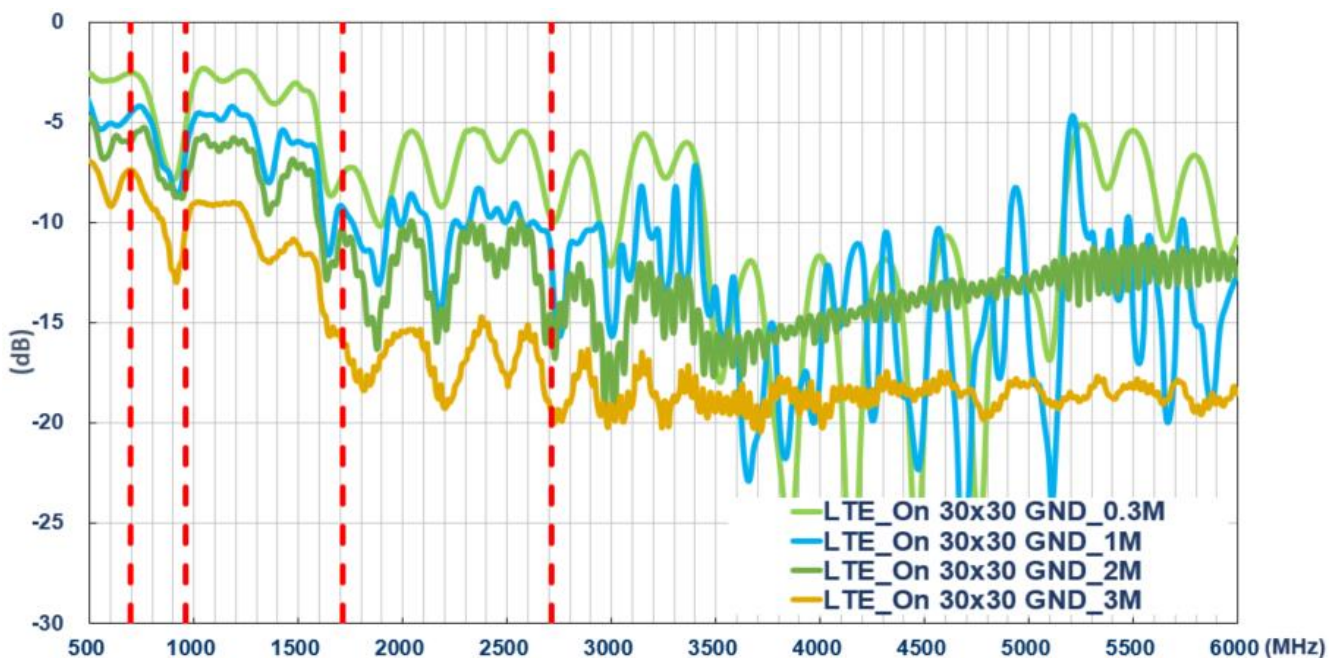

## 7.2 Efficiency

Efficiency – LTE Antenna (Free Space)

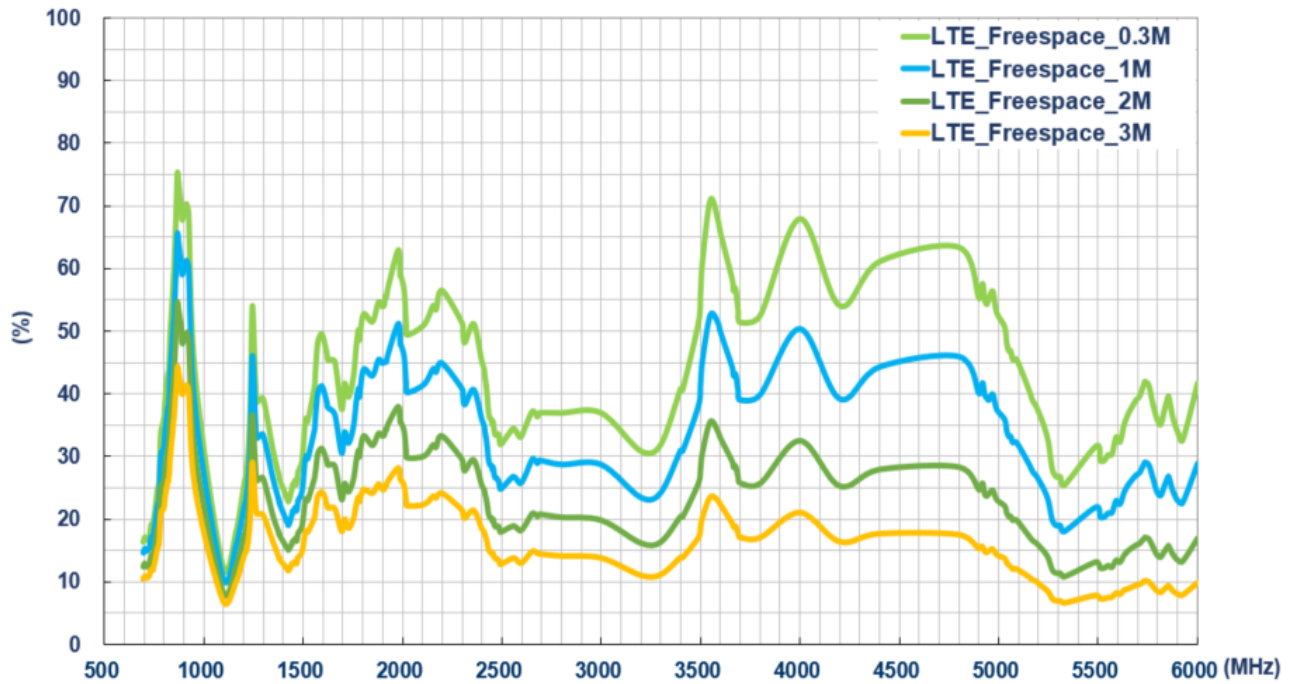

Efficiency – LTE Antenna (On 30\*30 GND)

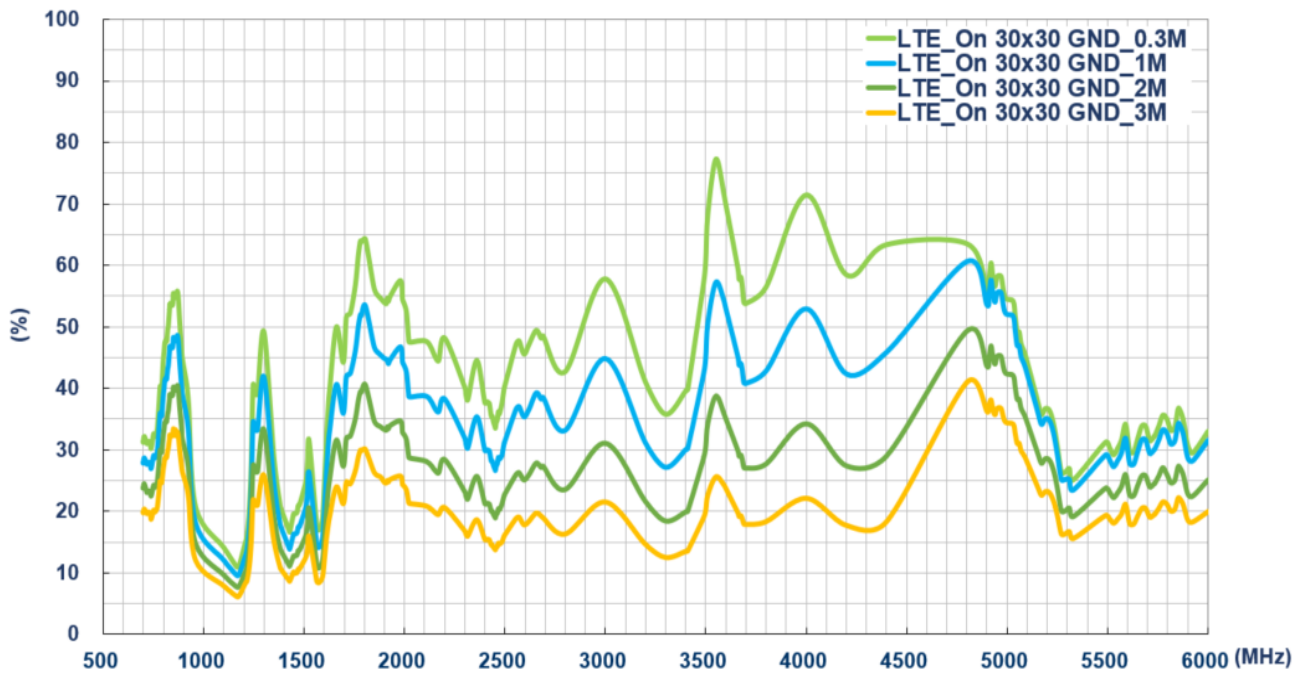

### 7.3 Average Gain

Average Gain – LTE Antenna (Free Space)

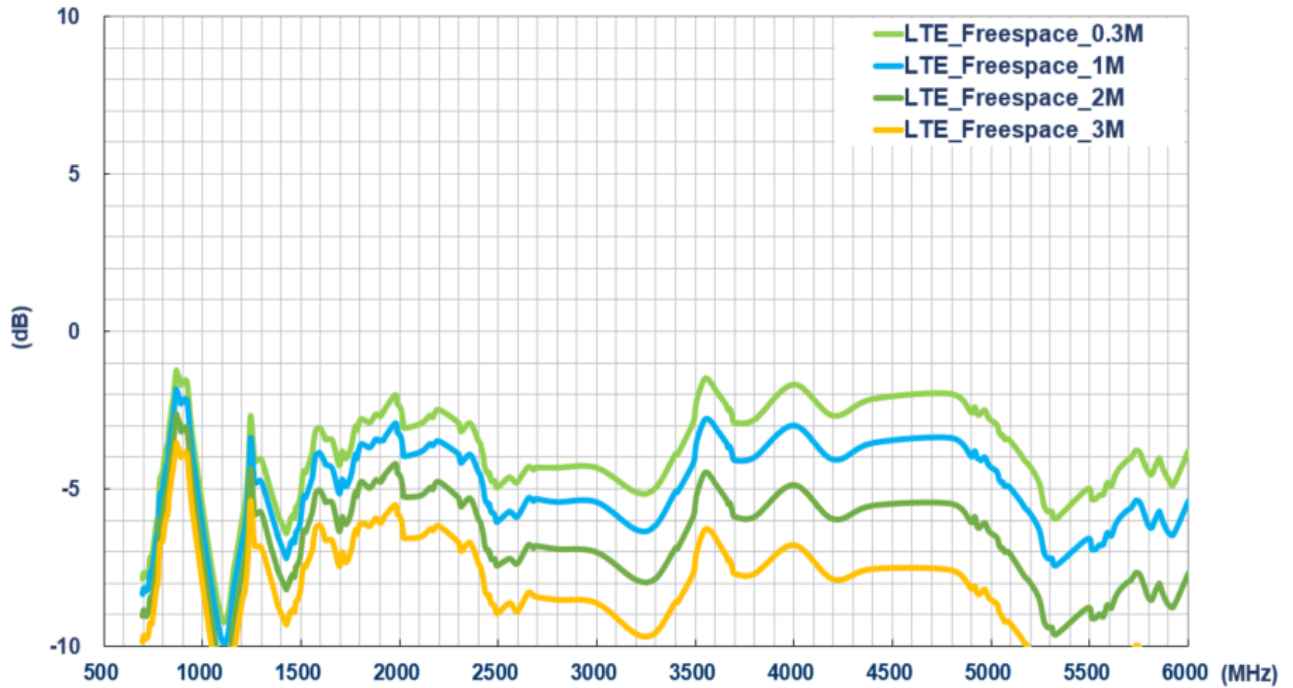

Average Gain – LTE Antenna (On 30\*30cm GND)

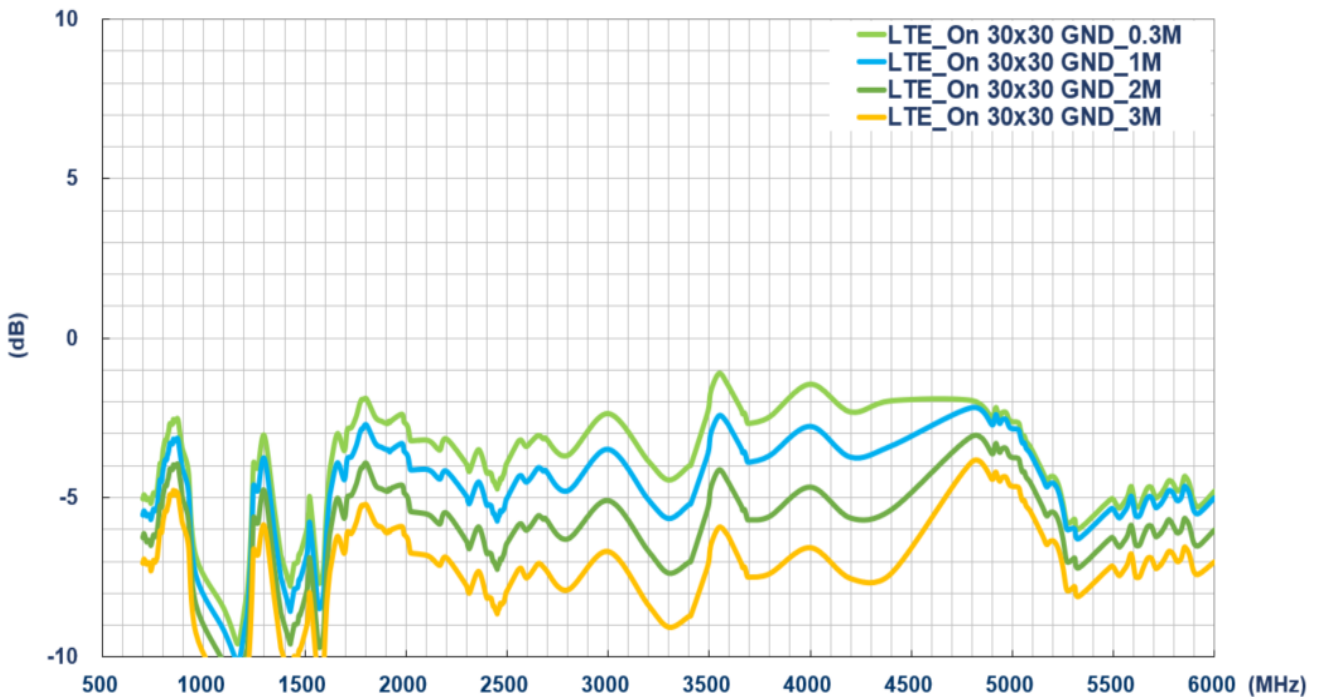

## 7.4 Peak Gain

Peak Gain – LTE Antenna (Free Space)

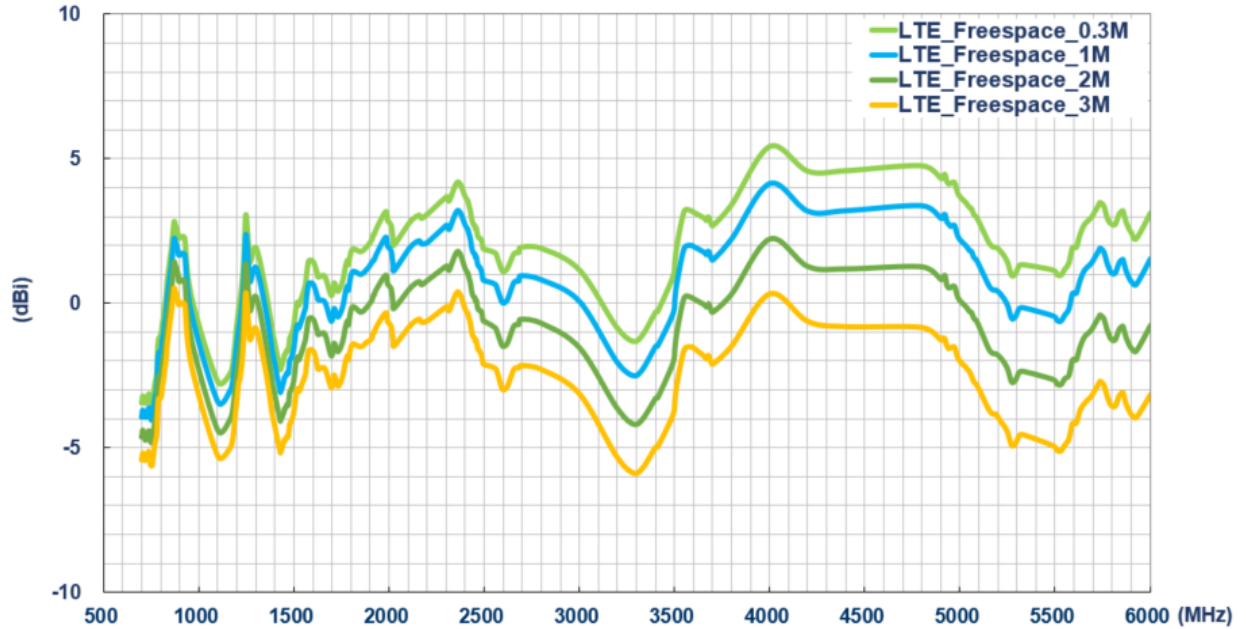

Peak Gain – LTE Antenna (On 30\*30cm GND)

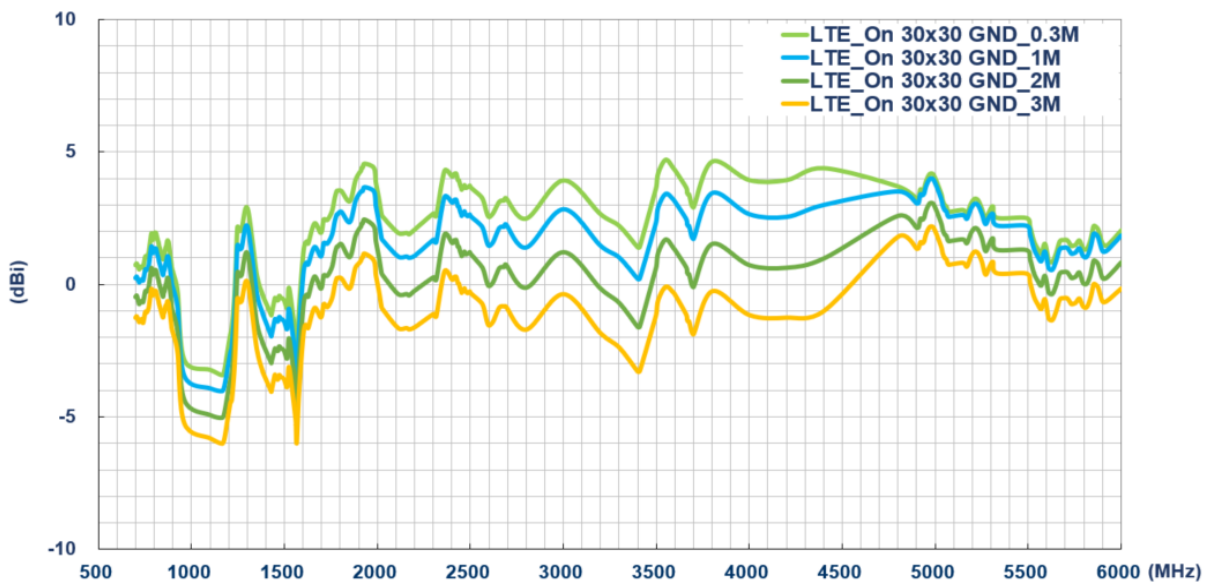

Changelog for the datasheet

**SPE-18-8-088 – MA310.A.LB.001**

**Revision: A (Original First Release)**

Date:	2019-02-22
Notes:	Initial Datasheet Release
Author:	Yu Kai Yeung

**Previous Revisions**

---

Previous Revisions (Continued)



**TAOGLAS®**

[www.taoglas.com](http://www.taoglas.com)



## Looking for pricing, stock, or lifecycle information?

Click below to explore more details on WIN SOURCE:

- ⊖ [View MA310.A.LB.001 on WIN SOURCE](#)
- ⊖ [Taoglas Limited Information](#)

## Optimize Your Supply Chain with WIN SOURCE Solutions

- ✓ Global Sourcing Solution
- ✓ Obsolete Management
- ✓ Cost Control Management
- ✓ Shortage Management
- ✓ Alternative Solution
- ✓ Excess Inventory Management