



# THE DATASHEET OF CLCUSB30IMP10X



# COMLINEAR® CLCUSB30

## Low Power, High-Speed (480MSPS) USB 2.0 Analog Switch

### FEATURES

- ±8kV ESD protection on all pins
- 7pF on capacitance
- 4.0Ω on resistance
- 720MHz -3dB bandwidth
- <1μA supply current in standby mode
- <6μA over a wide control voltage range
- -45dB crosstalk
- Power-off protection when  $V_S = 0V$ ; D+ and D- tolerate up to 5.25V
- Power-on protection when  $V_S \neq 0V$ ; D+ and D- tolerate up to 5.25V
- Input voltage range extends 0.3V beyond  $V_S$
- Operates from 3V to 4.3V supplies
- Pb-free MSOP-10 package

### APPLICATIONS

- Cell phones
- PDAs
- Digital cameras
- Notebooks
- LCD TVs
- Set top box
- High-speed differential signal applications
- USB 2.0 switching

### General Description

The CLCUSB30 is a dual-pole, double-throw (DPDT) analog switch designed for switching high-speed analog signals. The CLCUSB30 is optimized for switching 480Mbps (USB2.0) signals in portable devices such as cell phones, digital cameras, PDAs, and notebook computers.

The CLCUSB30 offers superior crosstalk (-45dB) and off-isolation (-30dB) to reduce channel-to-channel interference and provide good signal integrity. The low on-channel resistance and capacitance reduce attenuation and distortion during bi-directional HS signal routing.

The CLCUSB30 also features protection circuitry on D+ and D- pins that allows the switch to handle overvoltage conditions when powered on or off.

### Functional Block Diagram

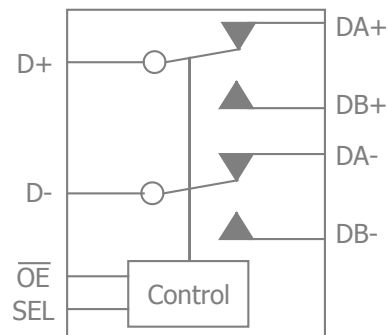

### Typical Application

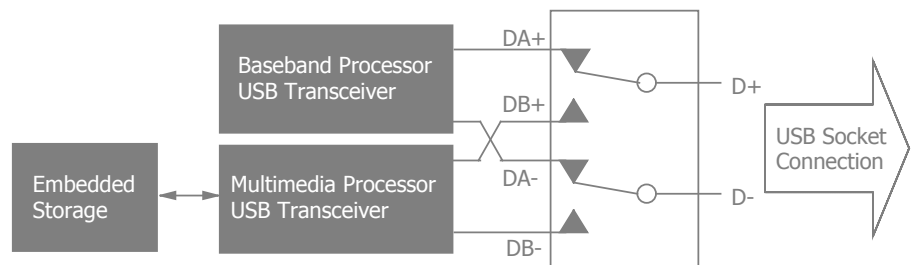

### Ordering Information

Part Number	Package	Pb-Free	RoHS Compliant	Operating Temperature Range	Packaging Method
CLCUSB30IMP10X	MSOP-10	Yes	Yes	-40°C to +125°C	Reel

Moisture sensitivity level for all parts is MSL-1.



## Pin Configuration

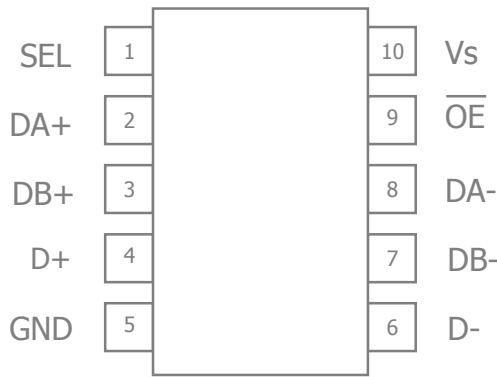

## Pin Assignments

Pin No.	Pin Name	Description
1	SEL	Select Input
2	DA+	A Data Port
3	DB+	B Data Port
4	D+	Common Data Port
5	GND	Ground
6	D-	Common Data Port
7	DB-	B Data Port
8	DA-	A Data Port
9	$\overline{OE}$	Output Enable Bar
10	V <sub>S</sub>	Positive supply

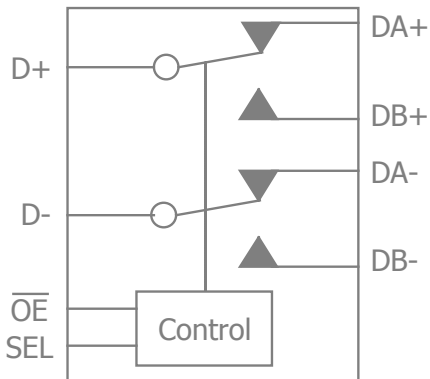

## Truth Table

SEL	$\overline{OE}$	Function
X	HIGH	Disconnect
LOW	LOW	Select A Port; (D+, D- = DA+, DA-)
HIGH	LOW	Select B Port; (D+, D- = DB+, DB-)



## Absolute Maximum Ratings

The safety of the device is not guaranteed when it is operated above the "Absolute Maximum Ratings". The device should not be operated at these "absolute" limits. Adhere to the "Recommended Operating Conditions" for proper device function. The information contained in the Electrical Characteristics tables and Typical Performance plots reflect the operating conditions noted on the tables and plots.

Parameter	Min	Max	Unit
Supply Voltage	-0.5	4.6	V
SEL Voltage	-0.5	4.6	V
Input Voltage Range (DA/B+, DA/B-)	0.5	+V <sub>S</sub> +0.3V	V
Input Voltage Range (D+, D- when V <sub>S</sub> > 0)	0.5	+V <sub>S</sub> +0.3V	V
Input Voltage Range (D+, D- when V <sub>S</sub> = 0)	-0.5	5.25	V
Input / Output Current		50	mA

## Reliability Information

Parameter	Min	Typ	Max	Unit
Junction Temperature			150	°C
Storage Temperature Range	-65		150	°C
Lead Temperature (Soldering, 10s)			260	°C
Package Thermal Resistance				
10-Lead MSOP		130		°C/W

Notes:

Package thermal resistance ( $\theta_{JA}$ ), JEDEC standard, multi-layer test boards, still air.

## ESD Protection

Product	MSOP-10
Human Body Model (HBM)	8kV
Charged Device Model (CDM)	2kV
Charged Device Model (MM)	400V

## Recommended Operating Conditions

Parameter	Min	Typ	Max	Unit
Operating Temperature Range	-40		+125	°C
Supply Voltage Range	3		4.3	V
SEL Voltage Range	0		V <sub>S</sub>	V
Input Voltage Range (D+, D-, DA/B+, DA/B-)	0		V <sub>S</sub>	V

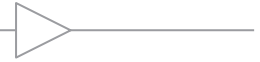

## Electrical Characteristics

$T_A = 25^\circ\text{C}$ ,  $V_S = +3\text{V}$ ; unless otherwise noted.

Symbol	Parameter	Conditions	Min	Typ	Max	Units
Frequency Domain Response						
BW <sub>-3dB</sub>	-3dB Bandwidth	$R_L = R_S = 50\Omega$ , $C_L = 0\text{pF}$		720		MHz
		$R_L = R_S = 50\Omega$ , $C_L = 5\text{pF}$		550		MHz
Time Domain Response						
$t_{\text{ON}}$	Turn-On Time	$V_{\text{IN/OUT}} = 0.8\text{V}$ , $R_L = 50\Omega$ , $C_L = 5\text{pF}$ , $V_{\text{SEL\_HIGH}} = V_S$ , $V_{\text{SEL\_LOW}} = 0$ , $3 \leq V_S \leq 3.6\text{V}$		13		ns
$t_{\text{OFF}}$	Turn-Off Time	$V_{\text{IN/OUT}} = 0.8\text{V}$ , $R_L = 50\Omega$ , $C_L = 5\text{pF}$ , $V_{\text{SEL\_HIGH}} = V_S$ , $V_{\text{SEL\_LOW}} = 0$ , $3 \leq V_S \leq 3.6\text{V}$		12		ns
$t_{\text{PD\_RISE/FALL}}$	Rise/Fall Propagation Delay	$R_L = R_S = 50\Omega$ , $C_L = 5\text{pF}$ , $V_S = 3.3\text{V}$		0.25		ns
$t_{\text{BBM}}$	Break-Before-Make Delay Time	$R_L = R_S = 50\Omega$ , $C_L = 5\text{pF}$ , $3 \leq V_S \leq 3.6\text{V}$		5		ns
$t_{\text{SK1}}$	Output Skew Between Switches	Skew between Switch 1 and Switch 2, $R_L = 50\Omega$ , $C_L = 5\text{pF}$ , $3 \leq V_S \leq 3.6\text{V}$		0.05		ns
$t_{\text{SK2}}$	Output Skew of Same Switches	Skew between opposite transitions in same switch, $R_L = 50\Omega$ , $C_L = 5\text{pF}$ , $3 \leq V_S \leq 3.6\text{V}$		0.02		ns
Distortion/Noise Response						
OFF <sub>ISO</sub>	Off Isolation	$f = 240\text{MHz}$ , $R_L = R_S = 50\Omega$ , $C_L = 0\text{pF}$ , $V_S = 3\text{V}$		-30		dB
X <sub>TALK</sub>	Crosstalk	Channel-to-channel at $f = 240\text{MHz}$ , $R_L = R_S = 50\Omega$ , $C_L = 0\text{pF}$ , $V_S = 3\text{V}$		-45		dB
DC Performance						
V <sub>SEL\_HIGH</sub>	Control Input High Voltage	$3 \leq V_S \leq 3.6\text{V}$	1.3			V
		$V_S = 4.3\text{V}$	1.7			V
V <sub>SEL\_LOW</sub>	Control Input Low Voltage	$3 \leq V_S \leq 3.6\text{V}$			0.5	V
		$V_S = 4.3\text{V}$			0.7	V
I <sub>SEL</sub>	Control Input Leakage Current	$0 \leq V_{\text{SEL}} \leq V_S$ , $V_S = 4.3\text{V}$	-1		1	$\mu\text{A}$
I <sub>S</sub>	Quiescent Supply Current	$V_{\text{SEL}} = 0\text{V}$ or $V_S$ , $I_{\text{IN/OUT}} = 0\text{A}$			1	$\mu\text{A}$
I <sub>ST</sub>	Increase in I <sub>S</sub> on V <sub>S</sub> pin per Control Voltage	$V_{\text{SEL}} = 2.6\text{V}$ , $V_S = 4.3\text{V}$			10	$\mu\text{A}$
		$V_{\text{SEL}} = 1.8\text{V}$ , $V_S = 4.3\text{V}$			30	$\mu\text{A}$
I <sub>LEAK</sub>	OFF-State Leakage Current on D $\pm$ , DA/B $\pm$	$0 < V_{\text{D}\pm, \text{DA}\pm, \text{DB}\pm} \leq 3.6\text{V}$ , $V_S = 4.3\text{V}$	-2		2	$\mu\text{A}$
I <sub>OFF</sub>	Power OFF Leakage Current on D $\pm$	$V_{\text{D}\pm} = 4.3\text{V}$ , $V_S = 0\text{V}$	-2		2	$\mu\text{A}$
R <sub>ON</sub>	ON Resistance	$V_{\text{IN/OUT}} = 0.4\text{V}$ , $I_{\text{IN/OUT}} = 8\text{mA}$ , $V_S = 3\text{V}$		4	6.5	$\Omega$
$\Delta R_{\text{ON}}$	ON Resistance Match Between Channels <sup>(1)</sup>	$V_{\text{IN/OUT}} = 0.4\text{V}$ , $I_{\text{IN/OUT}} = 8\text{mA}$ , $V_S = 3\text{V}$		0.35		$\Omega$
R <sub>FLAT\_ON</sub>	R <sub>ON</sub> Flatness <sup>(2)</sup>	$0\text{V} < V_{\text{IN/OUT}} \leq 1.0\text{V}$ , $I_{\text{IN/OUT}} = 8\text{mA}$ , $V_S = 3\text{V}$		1		$\Omega$
Capacitance						
C <sub>IN</sub>	Control Pin Input Capacitance	$f = 240\text{MHz}$ , $V_S = 0\text{V}$		1.5		pF
C <sub>ON</sub>	ON Capacitance	$f = 240\text{MHz}$ , $V_S = 3.6\text{V}$		7		pF
C <sub>OFF</sub>	OFF Capacitance	$f = 240\text{MHz}$ , $V_S = 3.6\text{V}$		3.5		pF

### Notes:

- $\Delta R_{\text{ON(MAX)}} = |R_{\text{ON}}(\text{Channel1}) - R_{\text{ON}}(\text{Channel2})|$
- R<sub>FLAT\\_ON</sub> is defined as the difference between the maximum and minimum value of R<sub>ON</sub> measured over specified V<sub>IN/OUT</sub> range.



## Typical Performance Characteristics

$T_A = 25^\circ\text{C}$ ,  $V_S = +3\text{V}$ ; unless otherwise noted.

Eye Diagram

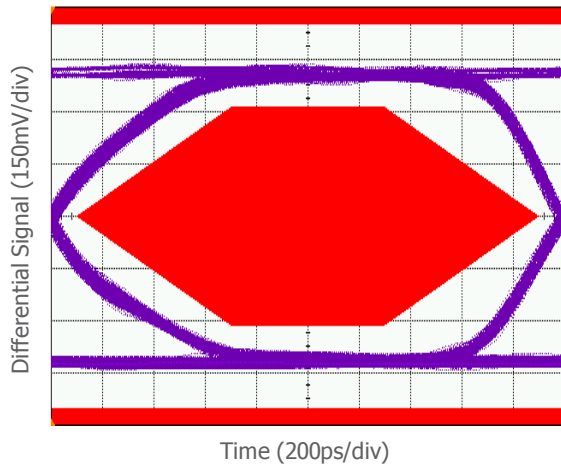

Off Isolation vs. Frequency

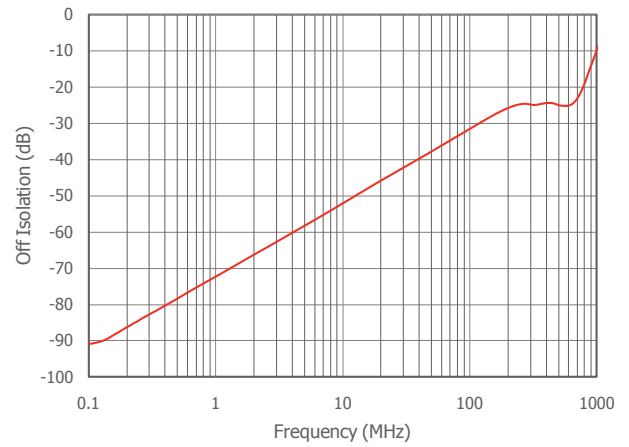

Crosstalk vs. Frequency

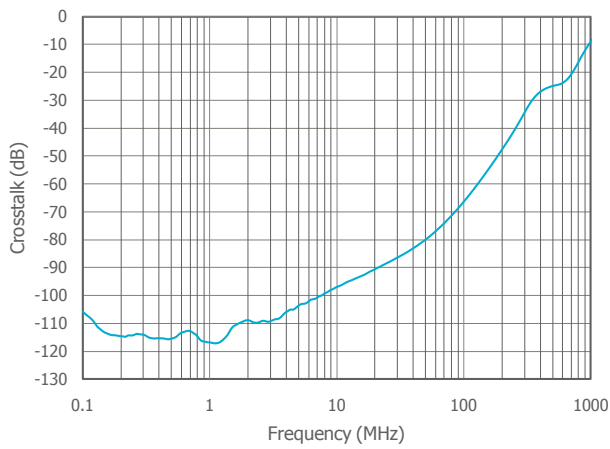

Gain vs. Frequency

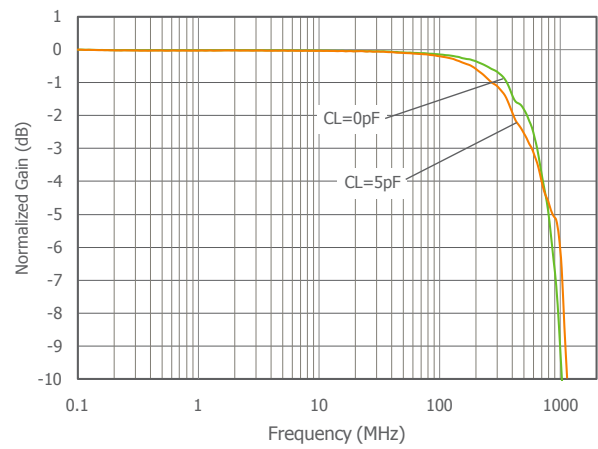



Timing Diagrams

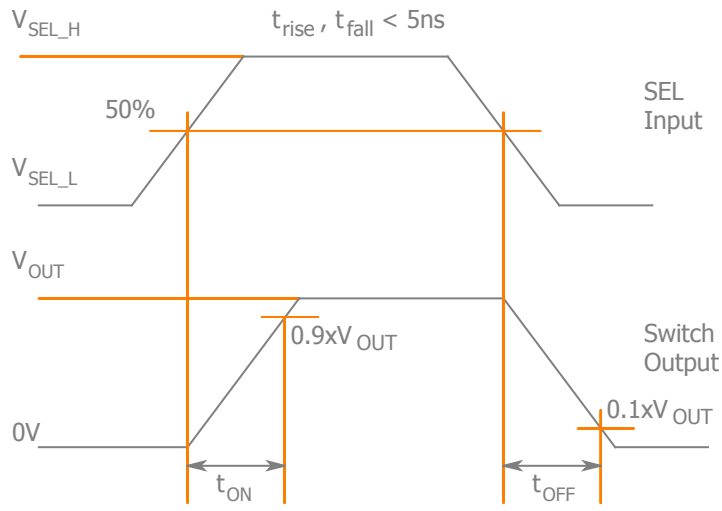

Figure 1.  $t_{ON}$ ,  $t_{OFF}$

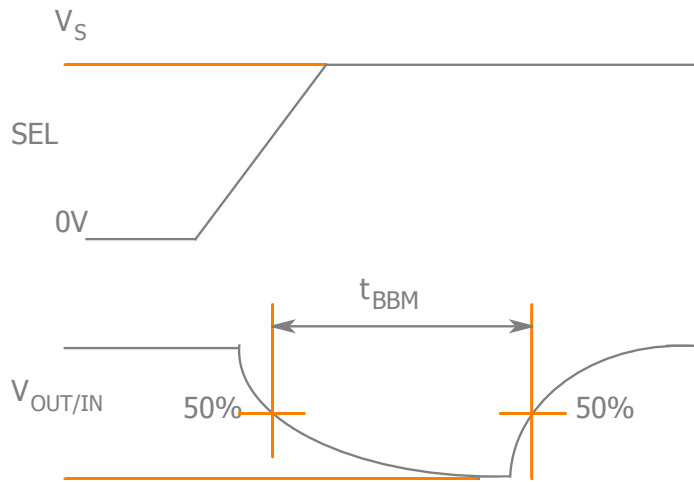
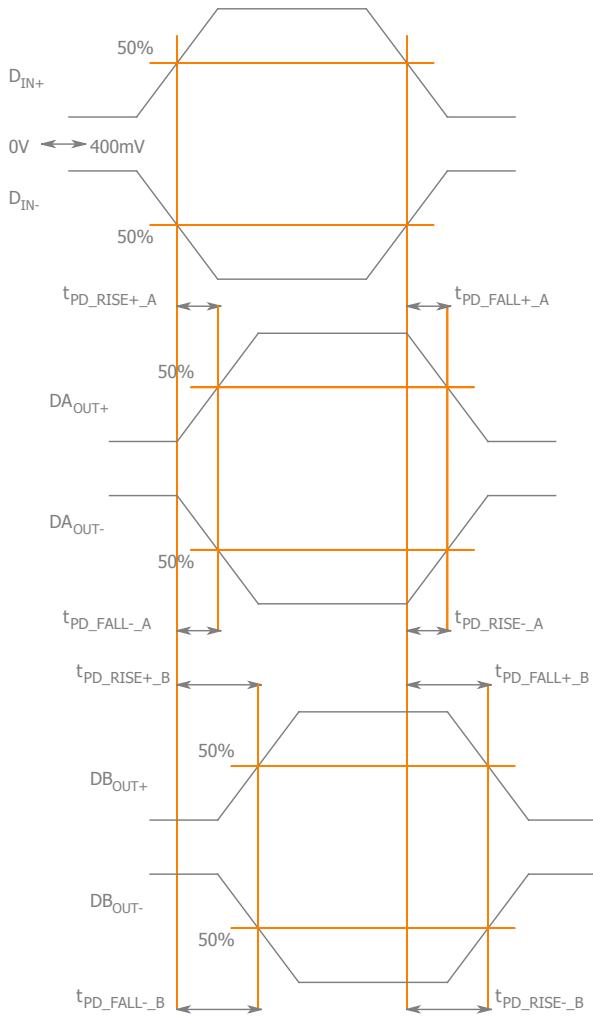

Figure 2. Break - Before - Make Time



### Rise-Time Propagation Delay

$t_{PD\_RISE+}$ ,  $t_{PD\_RISE-}$

### Fall-Time Propagation Delay

$t_{PD\_FALL+}$ ,  $t_{PD\_FALL-}$

### Output Skew Between Switches

$$t_{SK(O)} = | (t_{PD\_RISE+/-\_A}) - (t_{PD\_RISE+/-\_B}) |$$

$$\text{OR } t_{SK(O)} = | (t_{PD\_FALL+/-\_A}) - (t_{PD\_FALL+/-\_B}) |$$

### Output Skew Same Switch

$$t_{SK(P)} = | (t_{PD\_RISE+\_A/B}) - (t_{PD\_FALL+\_A/B}) |$$

$$\text{OR } t_{SK(P)} = | (t_{PD\_RISE-\_A/B}) - (t_{PD\_FALL-\_A/B}) |$$

Figure 3. Rise / Fall Propagation Delay & Skew



## Mechanical Dimensions

MSOP-10 Package (compliant to JEDEC MO-187)

**NOTE:**

- 1) CONTROLLING DIMENSION: INCHES.
- 2) PACKAGE LENGTH DOES NOT INCLUDE MOLD FLASH, PROTRUSIONS OR GATE BURR.
- 3) PACKAGE WIDTH DOES NOT INCLUDE INTERLEAD FLASH OR PROTRUSIONS.

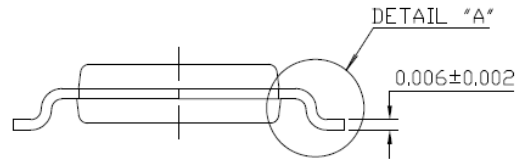
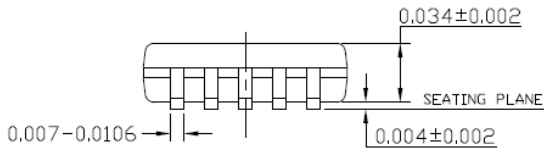
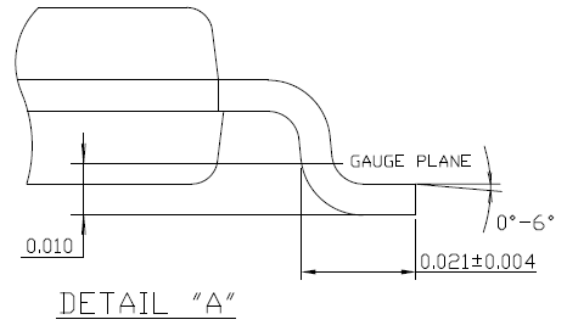
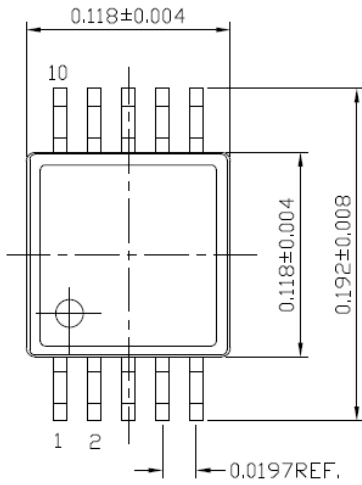

**For Further Assistance:**

**Exar Corporation Headquarters and Sales Offices**

48720 Kato Road Tel.: +1 (510) 668-7000  
 Fremont, CA 94538 - USA Fax: +1 (510) 668-7001  
 www.exar.com



A New Direction in Mixed-Signal

**NOTICE**  
 EXAR Corporation reserves the right to make changes to the products contained in this publication in order to improve design, performance or reliability. EXAR Corporation assumes no responsibility for the use of any circuits described herein, conveys no license under any patent or other right, and makes no representation that the circuits are free of patent infringement. Charts and schedules contained here in are only for illustration purposes and may vary depending upon a user's specific application. While the information in this publication has been carefully checked; no responsibility, however, is assumed for inaccuracies.

EXAR Corporation does not recommend the use of any of its products in life support applications where the failure or malfunction of the product can reasonably be expected to cause failure of the life support system or to significantly affect its safety or effectiveness. Products are not authorized for use in such applications unless EXAR Corporation receives, in writing, assurances to its satisfaction that: (a) the risk of injury or damage has been minimized; (b) the user assumes all such risks; (c) potential liability of EXAR Corporation is adequately protected under the circumstances.

Reproduction, in part or whole, without the prior written consent of EXAR Corporation is prohibited.

## Looking for pricing, stock, or lifecycle information?

Click below to explore more details on WIN SOURCE:

- ⊖ [View CLCUSB30IMP10X on WIN SOURCE](#)
- ⊖ [Exar Corporation](#) Information

## Optimize Your Supply Chain with WIN SOURCE Solutions

- ✓ Global Sourcing Solution
- ✓ Obsolete Management
- ✓ Cost Control Management
- ✓ Shortage Management
- ✓ Alternative Solution
- ✓ Excess Inventory Management