



**THE DATASHEET OF  
APA2106SRCPRV**



Part Number: APA2106SRCPRV

Super Bright Red

### Features

- 2.1mmX0.6mm right angle SMT LED, 1.0mm thickness.
- Low power consumption.
- Wide viewing angle.
- Ideal for backlight and indicator.
- Various colors and lens types available.
- Package: 2000pcs / reel.
- Moisture sensitivity level : level 3.
- RoHS compliant.

### Description

The Super Bright Red source color devices are made with Gallium Aluminum Arsenide Red Light Emitting Diode.

### Package Dimensions

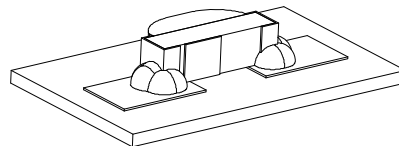
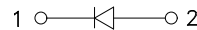
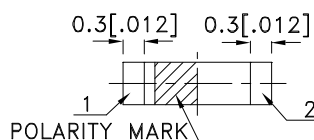
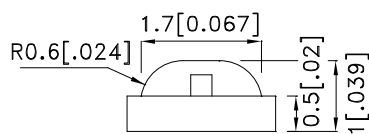
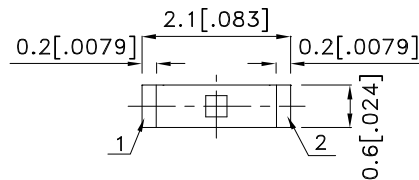

#### Notes:

1. All dimensions are in millimeters (inches).
2. Tolerance is  $\pm 0.1$  (0.004") unless otherwise noted.
3. The specifications, characteristics and technical data described in the datasheet are subject to change without prior notice.
4. The device has a single mounting surface. The device must be mounted according to the specifications



## Selection Guide

Part No.	Dice	Lens Type	Iv (mcd) [2] @ 20mA		Viewing Angle [1]
			Min.	Typ.	2θ1/2
APA2106SRCPRV	Super Bright Red (GaAlAs)	Water Clear	55	100	120°
			*12	*30	

Notes:

1. θ1/2 is the angle from optical centerline where the luminous intensity is 1/2 of the optical peak value.
2. Luminous intensity/ Luminous Flux: +/-15%.

\* Luminous intensity value is traceable to the CIE127-2007 compliant national standards.

## Electrical / Optical Characteristics at TA=25°C

Symbol	Parameter	Device	Typ.		Max.	Units	Test Conditions
λ <sub>peak</sub>	Peak Wavelength	Super Bright Red	660	*655		nm	I <sub>F</sub> =20mA
λ <sub>D</sub> [1]	Dominant Wavelength	Super Bright Red	640	*640		nm	I <sub>F</sub> =20mA
Δλ <sub>1/2</sub>	Spectral Line Half-width	Super Bright Red	20			nm	I <sub>F</sub> =20mA
C	Capacitance	Super Bright Red	45			pF	V <sub>F</sub> =0V;f=1MHz
V <sub>F</sub> [2]	Forward Voltage	Super Bright Red	1.85		2.5	V	I <sub>F</sub> =20mA
I <sub>R</sub>	Reverse Current	Super Bright Red			10	uA	V <sub>R</sub> = 5V

Notes:

1. Wavelength: +/-1nm.
  2. Forward Voltage: +/-0.1V.
- \* Wavelength value is traceable to the CIE127-2007 compliant national standards.

## Absolute Maximum Ratings at TA=25°C

Parameter	Super Bright Red	Units
Power dissipation	75	mW
DC Forward Current	30	mA
Peak Forward Current [1]	155	mA
Reverse Voltage	5	V
Operating Temperature	-40°C To +85°C	
Storage Temperature	-40°C To +85°C	

Note:

1. 1/10 Duty Cycle, 0.1ms Pulse Width.

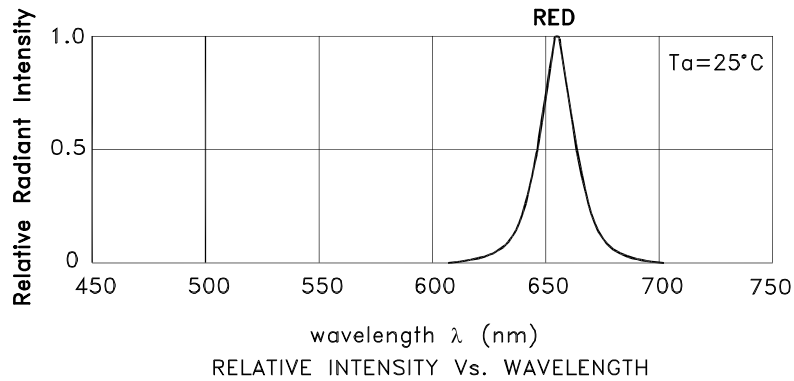

## Super Bright Red

## APA2106SRCPRV

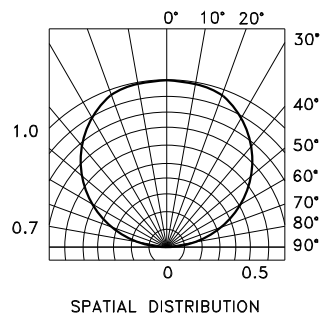
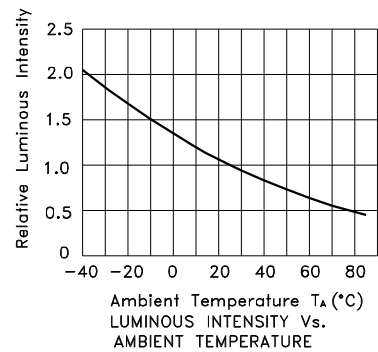
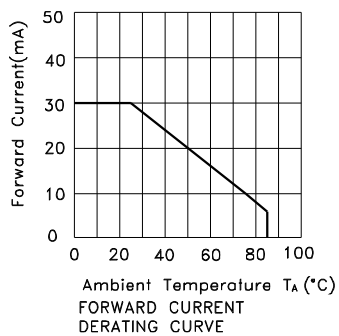
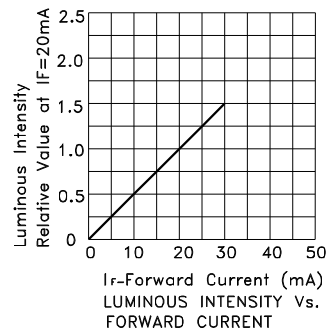
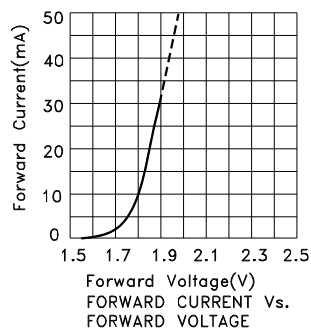

## APA2106SRCPRV

Reflow soldering is recommended and the soldering profile is shown below.  
Other soldering methods are not recommended as they might cause damage to the product.

Reflow Soldering Profile For Lead-free SMT Process.

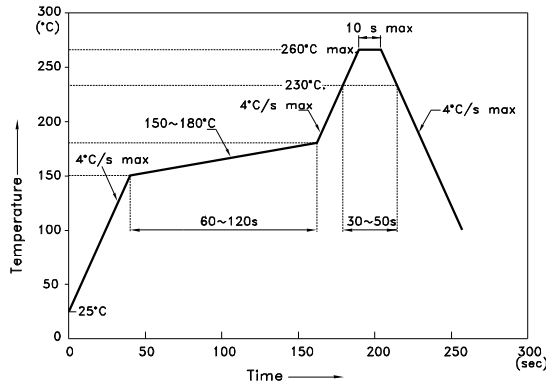

NOTES:

1. We recommend the reflow temperature 245°C(+/-5°C). The maximum soldering temperature should be limited to 260°C.
2. Don't cause stress to the epoxy resin while it is exposed to high temperature.
3. Number of reflow process shall be 2 times or less.

### Recommended Soldering Pattern (Units : mm; Tolerance: ± 0.1)

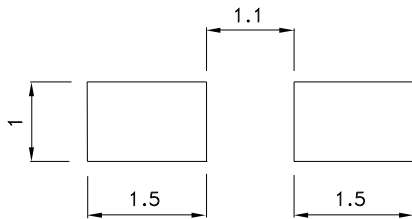

### Reel Dimension

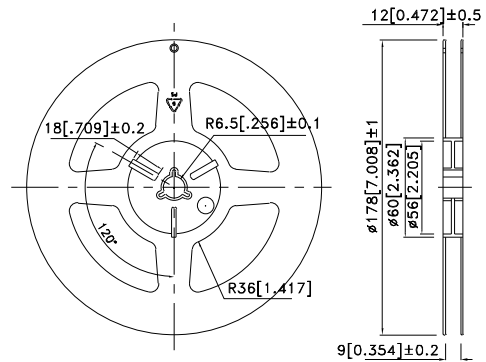

### Tape Dimensions (Units : mm)

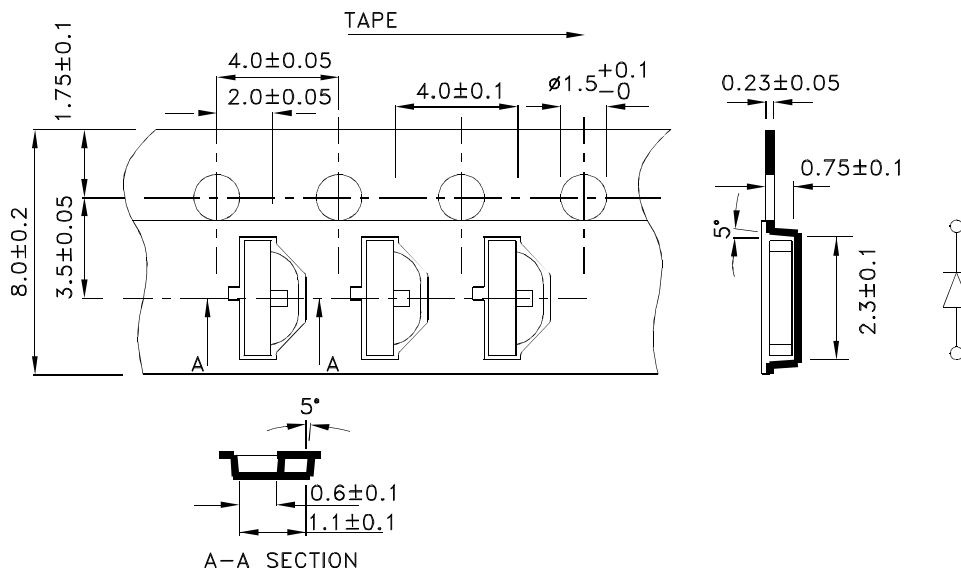

# Kingbright

## PACKING & LABEL SPECIFICATIONS

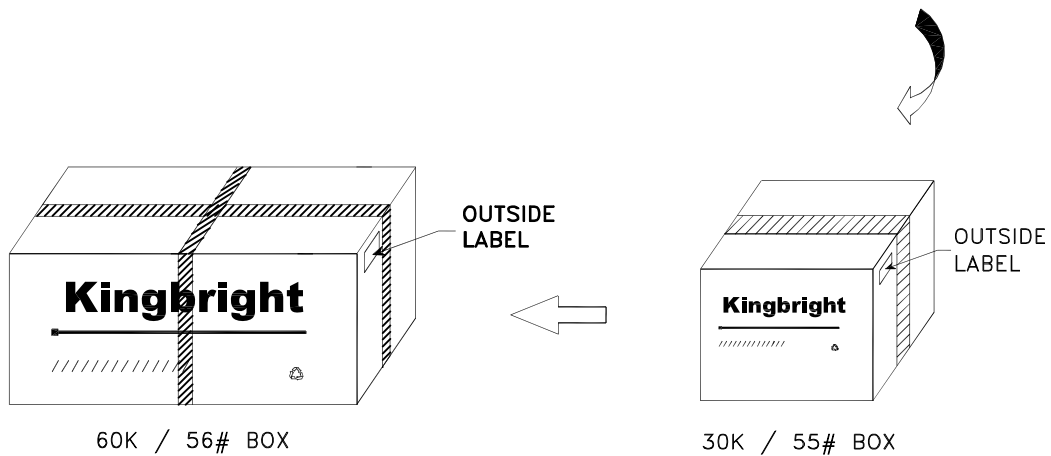
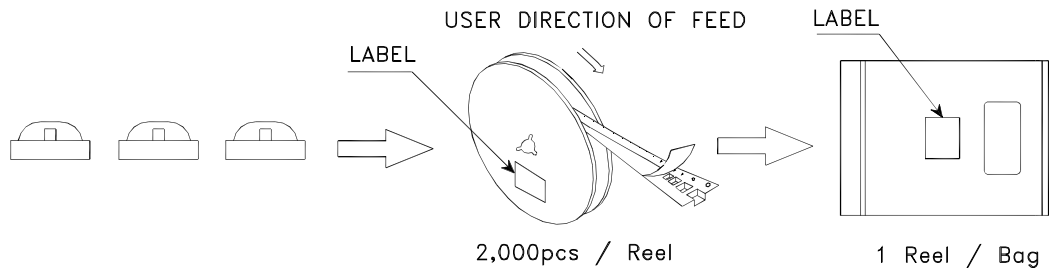

## APA2106SRCPRV



<h1>Kingbright</h1>				
P/NO: APA2106xxx				
QTY: 2,000 pcs	Q.C.			
S/N: XXXX	<table border="1"> <tr> <td style="text-align: center;">Q C</td> </tr> <tr> <td style="text-align: center;">XX XX XXXX</td> </tr> <tr> <td style="text-align: center;">PASSED</td> </tr> </table>	Q C	XX XX XXXX	PASSED
Q C				
XX XX XXXX				
PASSED				
CODE: XXX				
LOT NO:				
 XXXXXXXXXXXXXXXXXXXXXXXXXXXX				
RoHS Compliant				

## Looking for pricing, stock, or lifecycle information?

Click below to explore more details on WIN SOURCE:

-  [View APA2106SRCPRV on WIN SOURCE](#)
-  [Kingbright Information](#)

## Optimize Your Supply Chain with WIN SOURCE Solutions

-  Global Sourcing Solution
-  Obsolete Management
-  Cost Control Management
-  Shortage Management
-  Alternative Solution
-  Excess Inventory Management