



**THE DATASHEET OF
TV04A401J-HF**



ATV04A5V0-HF Thru. ATV04A441-HF

Working Peak Reverse Voltage: 5.0 to 440 Volts

Power Dissipation: 400 Watts

RoHS Device
Halogen Free

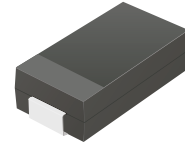

Features

- Glass passivated chip.
- 400W peak pulse power capability with a 10/1000 μ s waveform, repetitive rate (duty cycle):0.01%
- Low leakage.
- Uni and Bidirectional unit.
- Excellent clamping capability.
- Very fast response time.
- Comply with AEC-Q101
- UL recognized file # E349157  Range: ATV04A5V0J(B) thru. ATV04A240J(B)

Mechanical data

- Epoxy: UL 94V-0 rate flame retardant.
- Case: SMA/DO-214AC, molded plastic.
- Terminals: solderable per MIL-STD-750, method 2026.
- Polarity: Color band denotes cathode end except bipolar.
- Weight: 0.069 gram (approx.)

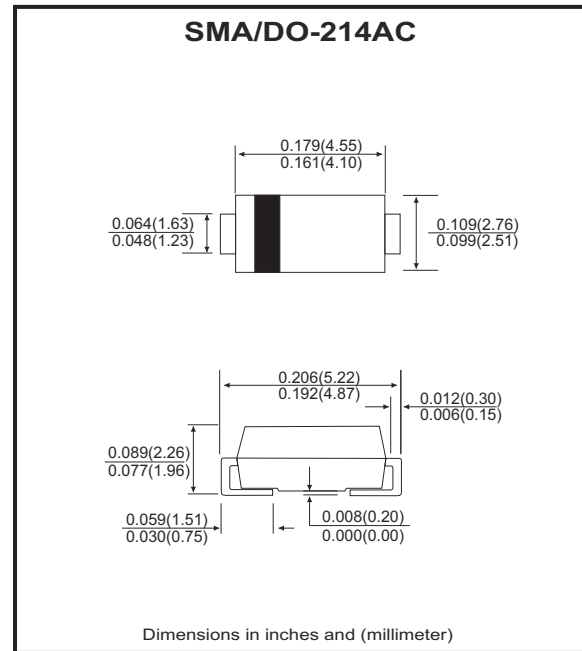

Maximum Ratings and Electrical Characteristics

Ratings at 25 °C ambient temperature unless otherwise specified.
Single phase, half wave, 60Hz, resistive or inductive load.
For capacitive load, derate current by 20%.

Characteristics	Symbol	Value	Units
Peak power dissipation on 10/1000 μ S waveform (Note1)	P _{PP}	400	W
Peak pulse current on 10/1000 μ S waveform (Note 1)	I _{PP}	See Next Table	A
Steady state power dissipation at T _L =75°C	P _D	1.0	W
Peak forward surge current, 8.3mS single half sine-wave unidirectional only (Note 2)	I _{FSM}	40	A
Maximum instantaneous forward voltage at 25.0A for unidirectional only (Note 3)	V _F	3.5/5.0	V
Operating junction and storage temperature	T _J , T _{STG}	-55 to +150	°C

Notes: 1. Non-repetitive current pulse, per Fig. 5 and derated above T_A=25°C, per Fig. 1.
2. Measured on 8.3mS single half sine-wave or equare wave,duty cycle=4 pulses per minute maximum.
3. V_F<3.5V for devices of V_{BR}<200V and V_F<5.0V for devices of V_{BR}>201V

RATING AND CHARACTERISTIC CURVES (ATV04A5V0-HF thru ATV04A441-HF)

Fig.1 - Pulse Derating Curve

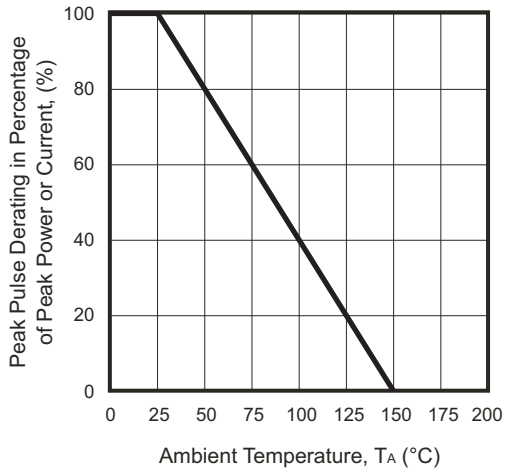

Fig.2 - Maximum Non-Repetitive Surge Current

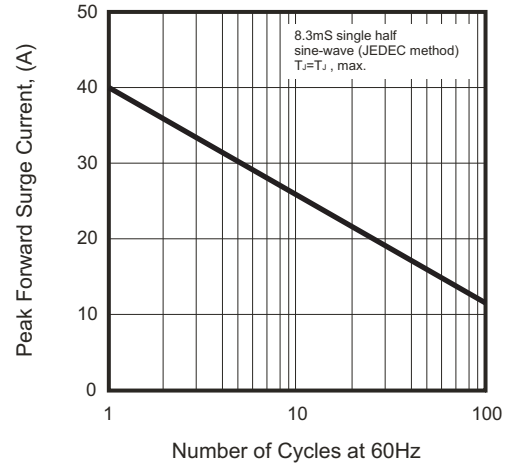

Fig.3 - Steady State Power Derating Curve

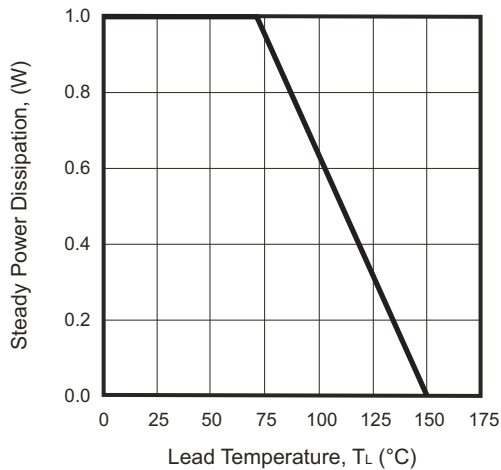

Fig.4 - Peak Pulse Power Rating Curve

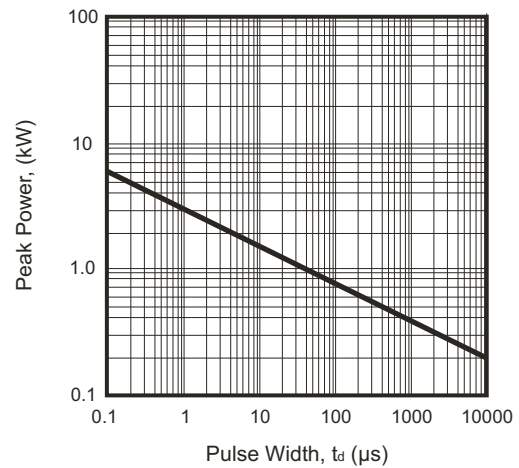

Fig.5 - Pulse Waveform

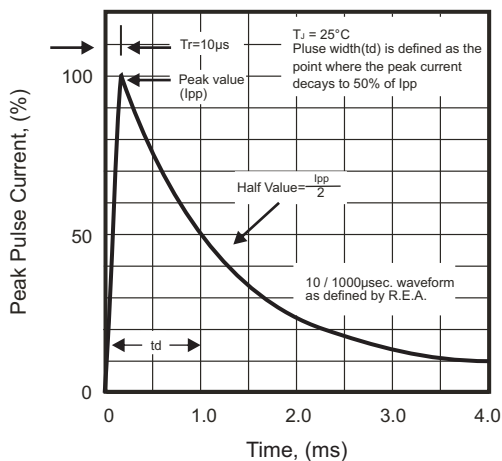
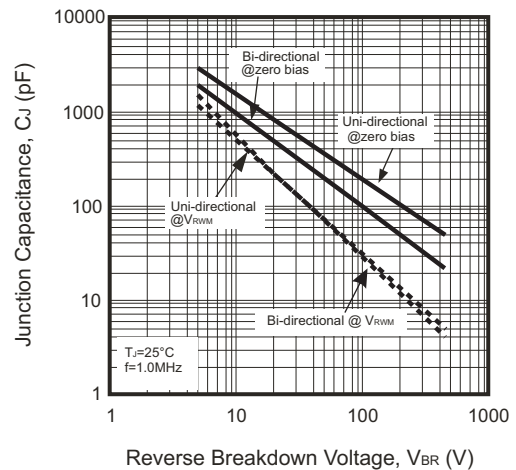

Fig.6 - Typical Junction Capacitance



SMD Transient Voltage Suppressor

Electrical Characteristics (ATV04A5V0-HF Thru. ATV04A441-HF)

Part No.	Breakdown voltage V _{BR} @ I _T			Maximum Reverse Leakage @V _{RWM} I _R (uA)	Working Peak Reverse Voltage V _{RWM} (V)	Maximum Reverse Surge Current I _{PP} (A)	Maximum Clamping Voltage @I _{PP} V _c (V)	Device Marking Code	
	Min. (V)	Max. (V)	I _T (mA)					UNI	BI
ATV04A5V0J(B)-HF	6.40	7.00	10	800	5.0	43.48	9.2	AE	WE
ATV04A6V0J(B)-HF	6.67	7.37	10	800	6.0	38.83	10.3	AG	WG
ATV04A6V5J(B)-HF	7.22	7.98	10	500	6.5	35.71	11.2	AK	WK
ATV04A7V0J(B)-HF	7.78	8.60	10	200	7.0	33.33	12.0	AM	WM
ATV04A7V5J(B)-HF	8.33	9.21	1	100	7.5	31.01	12.9	AP	WP
ATV04A8V0J(B)-HF	8.89	9.83	1	50	8.0	29.41	13.6	AR	WR
ATV04A8V5J(B)-HF	9.44	10.40	1	10	8.5	27.78	14.4	AT	WT
ATV04A9V0J(B)-HF	10.00	11.10	1	5	9.0	25.97	15.4	AV	WV
ATV04A100J(B)-HF	11.10	12.30	1	5	10.0	23.53	17.0	AX	WX
ATV04A110J(B)-HF	12.20	13.50	1	1	11.0	21.98	18.2	AZ	WZ
ATV04A120J(B)-HF	13.30	14.70	1	1	12.0	20.10	19.9	BE	XE
ATV04A130J(B)-HF	14.40	15.90	1	1	13.0	18.60	21.5	BG	XG
ATV04A140J(B)-HF	15.60	17.20	1	1	14.0	17.24	23.2	BK	XK
ATV04A150J(B)-HF	16.70	18.50	1	1	15.0	16.39	24.4	BM	XM
ATV04A160J(B)-HF	17.80	19.70	1	1	16.0	15.38	26.0	BP	XP
ATV04A170J(B)-HF	18.90	20.90	1	1	17.0	14.49	27.6	BR	XR
ATV04A180J(B)-HF	20.00	22.10	1	1	18.0	13.70	29.2	BT	XT
ATV04A190J(B)-HF	21.10	23.30	1	1	19.0	13.00	30.8	BB	XB
ATV04A200J(B)-HF	22.20	24.50	1	1	20.0	12.35	32.4	BV	XV
ATV04A220J(B)-HF	24.40	26.90	1	1	22.0	11.27	35.5	BX	XX
ATV04A240J(B)-HF	26.70	29.50	1	1	24.0	10.28	38.9	BZ	XZ
ATV04A260J(B)-HF	28.90	31.90	1	1	26.0	9.50	42.1	CE	YE
ATV04A280J(B)-HF	31.10	34.40	1	1	28.0	8.81	45.4	CG	YG
ATV04A300J(B)-HF	33.30	36.80	1	1	30.0	8.26	48.4	CK	YK
ATV04A330J(B)-HF	36.70	40.60	1	1	33.0	7.50	53.3	CM	YM
ATV04A360J(B)-HF	40.00	44.20	1	1	36.0	6.88	58.1	CP	YP
ATV04A400J(B)-HF	44.40	49.10	1	1	40.0	6.20	64.5	CR	YR
ATV04A430J(B)-HF	47.80	52.80	1	1	43.0	5.76	69.4	CT	YT
ATV04A450J(B)-HF	50.00	55.30	1	1	45.0	5.50	72.7	CV	YV
ATV04A480J(B)-HF	53.30	58.90	1	1	48.0	5.17	77.4	CX	YX
ATV04A510J(B)-HF	56.70	62.70	1	1	51.0	4.85	82.4	CZ	YZ
ATV04A540J(B)-HF	60.00	66.30	1	1	54.0	4.59	87.1	RE	ZE
ATV04A580J(B)-HF	64.40	71.20	1	1	58.0	4.27	93.6	RG	ZG
ATV04A600J(B)-HF	66.70	73.70	1	1	60.0	4.13	96.8	RK	ZK
ATV04A640J(B)-HF	71.10	78.60	1	1	64.0	3.88	103.0	RM	ZM
ATV04A700J(B)-HF	77.80	86.00	1	1	70.0	3.54	113.0	RP	ZP
ATV04A750J(B)-HF	83.30	92.10	1	1	75.0	3.31	121.0	RR	ZR
ATV04A780J(B)-HF	86.70	95.80	1	1	78.0	3.17	126.0	RT	ZT
ATV04A800J(B)-HF	88.80	97.60	1	1	80.0	3.09	129.6	RB	ZB
ATV04A850J(B)-HF	94.40	104.00	1	1	85.0	2.92	137.0	RV	ZV

Company reserves the right to improve product design , functions and reliability without notice.

REV:B

Electrical Characteristics (ATV04A5V0-HF Thru. ATV04A441-HF)

Part No.	Breakdown voltage V _{BR} @ I _T			Maximum Reverse Leakage @V _{RWM} I _R (uA)	Working Peak Reverse Voltage V _{RWM} (V)	Maximum Reverse Surge Current I _{PP} (A)	Maximum Clamping Voltage @I _{PP} V _c (V)	Device Marking Code	
	Min. (V)	Max. (V)	I _T (mA)					UNI	BI
ATV04A900J(B)-HF	100.0	111.0	1	1	90.0	2.74	146.0	RX	ZX
ATV04A101J(B)-HF	111.0	123.0	1	1	100.0	2.47	162.0	RZ	ZZ
ATV04A111J(B)-HF	122.0	135.0	1	1	110.0	2.26	177.0	SE	VE
ATV04A121J(B)-HF	133.0	147.0	1	1	120.0	2.07	193.0	SG	VG
ATV04A131J(B)-HF	144.0	159.0	1	1	130.0	1.91	209.0	SK	VK
ATV04A141J(B)-HF	155.0	171.0	1	1	140.0	1.76	226.8	SB	VB
ATV04A151J(B)-HF	167.0	185.0	1	1	150.0	1.65	243.0	SM	VM
ATV04A161J(B)-HF	178.0	197.0	1	1	160.0	1.54	259.0	SP	VP
ATV04A171J(B)-HF	189.0	209.0	1	1	170.0	1.45	275.0	SR	VR
ATV04A181J(B)-HF	200.0	220.0	1	1	180.0	1.37	291.6	ST	VT
ATV04A191J(B)-HF	211.0	232.0	1	1	190.0	1.30	307.8	SV	VV
ATV04A201J(B)-HF	224.0	247.0	1	1	200.0	1.23	324.0	SW	VW
ATV04A221J(B)-HF	246.0	272.0	1	1	220.0	1.12	356.0	SX	VX
ATV04A251J(B)-HF	279.0	309.0	1	1	250.0	0.99	405.0	SZ	VZ
ATV04A301J(B)-HF	335.0	371.0	1	1	300.0	0.82	486.0	DE	HE
ATV04A351J(B)-HF	391.0	432.0	1	1	350.0	0.71	567.0	DG	HG
ATV04A401J(B)-HF	447.0	494.0	1	1	400.0	0.62	648.0	DK	HK
ATV04A441J(B)-HF	492.0	543.0	1	1	440.0	0.56	713.0	DM	HM

Note:

- 1) Suffix J denotes 5% tolerance devices.
- 2) Suffix B after part number to specify Bi-directional devices.
- 3) For Bi-Directional devices having V_R of 10 volts and under, the I_R limit is double.

Reel Taping Specification

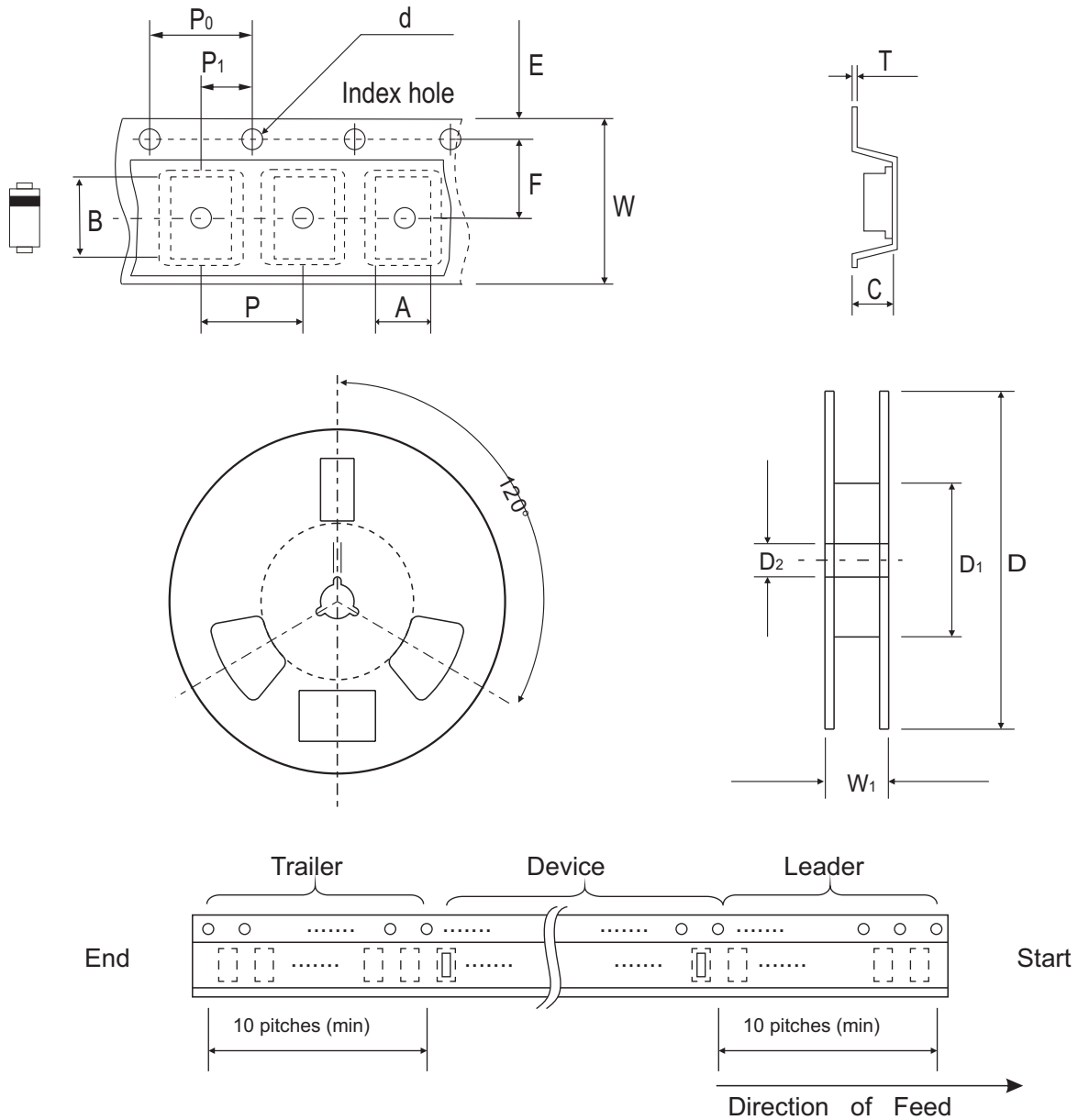

SMA/DO-214AC	SYMBOL	A	B	C	d	D	D1	D2
	(mm)	2.79 ± 0.10	5.33 ± 0.10	4.50 (max)	1.75 ± 0.10	330MAX	50.0 MIN.	13.0 ± 0.2
	(inch)	0.110 ± 0.004	0.210 ± 0.004	0.177 (max)	0.069 ± 0.004	13.00MAX	1.969 MIN.	0.512 ± 0.008

SMA/DO-214AC	SYMBOL	E	F	P	P0	P1	W	W1
	(mm)	1.75 ± 0.10	5.50 ± 0.05	4.00 ± 0.10	4.00 ± 0.10	2.00 ± 0.05	12.0 ± 0.30	18.4 MAX.
	(inch)	0.069 ± 0.004	0.216 ± 0.002	0.157 ± 0.004	0.157 ± 0.004	0.079 ± 0.002	0.472 ± 0.012	0.724 MAX.

Company reserves the right to improve product design , functions and reliability without notice.

REV:B

Marking Code

1. **C**: COMCHIP

2. **○**: Package

○	PKG
A	SMA
B	SMB
C	SMC

3. **XX**: Marking code (see Page. 3~4)

4. **█**: Cathod Band

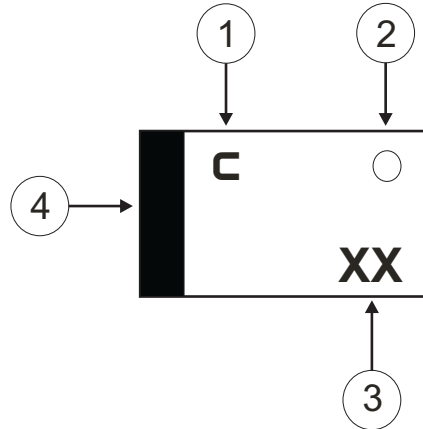

Suggested PAD Layout

SIZE	DO-214AC(SMA)	
	(mm)	(inch)
A	5.28	0.208
B	1.88 MAX	0.074 MAX
C	1.52 MIN	0.060 MIN
D	1.68 MIN	0.066 MIN

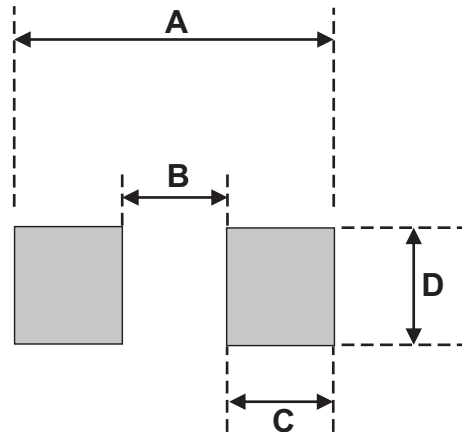

Standard Packaging





Case Type	REEL PACK	
	REEL (pcs)	Reel Size (inch)
SMA/DO-214AC	5,000	13

Looking for pricing, stock, or lifecycle information?

Click below to explore more details on WIN SOURCE:

-  [View TV04A401J-HF on WIN SOURCE](#)
-  [Comchip Technology Information](#)

Optimize Your Supply Chain with WIN SOURCE Solutions

-  Global Sourcing Solution
-  Obsolete Management
-  Cost Control Management
-  Shortage Management
-  Alternative Solution
-  Excess Inventory Management