



**THE DATASHEET OF
REFICL5102U52WCCTOBO1**



52 W low-cost two-stage LED driver based on ICL5102

A PFC + open-loop LCC design with tight LED current spread

Order code: SP005419724

About this document

Scope and purpose

ICL5102 is an integrated combo controller IC designed to drive and control the boost PFC + resonant half-bridge (HB) topology (LLC/LCC) in combination. The superior performance of its THD optimizer in the PFC part makes it very suitable for LED lighting applications. Infineon's proprietary coreless transformer-based high-side MOSFET driver enables a robust HB drive at high operating frequency.

This work demonstrates a highly efficient low-cost non-dimmable PFC + LCC LED driver based on ICL5102. Thanks to the integrated, robust and efficient HB MOSFET driver, the LCC stage is designed at high operating frequency (up to 250 kHz) to realize an integrated resonant transformer at lower cost. In this non-dimmable design, open-loop control is implemented for further cost reduction. The LCC resonant tank is designed in a particular manner for a tight LED current tolerance (± 10 percent), over a wide temperature range and with most IC and component tolerance taken into account. This is of great importance in the open-loop product design.

This report documents the experimental test results of this 52 W open-loop LCC demonstration board and LED current spread analysis.

Intended audience

This document is intended for technical experts who intend to use this ICL5102 demonstration board, either for their own applications and ICL5102 function tests, or as a reference for a new ICL5102-based product development.

Table of contents

About this document.....	1
1 IC introduction.....	3
2 Board description.....	4
2.1 Electrical specifications	5
2.2 Schematic and layout	6
2.3 Board setup	8
3 Electrical performance	9
3.1 System performance	9
3.2 Startup behavior	11
3.3 Steady-state	12
3.4 Protections	16
3.4.1 Brown-out protection	16
3.4.2 Output OVP.....	17
3.5 LED current spread analysis.....	17
4 Thermal performance	24

52 W low-cost two-stage LED driver based on ICL5102

A PFC + open-loop LCC design with tight LED current spread



About this document

5	EMI	25
6	Magnetic component datasheets	26
7	Electronics BOM	29
	Revision history.....	31

1 IC introduction

ICL5102 is an integrated combo IC designed to drive and control the boost PFC + resonant HB topology (LLC/LCC) in combination. Its high-voltage version, ICL5102HV, can handle 980 V (maximum value) on the half-bridge part, which is the highest voltage rating on the market so far. The pin maps of ICL5102 and ICL5102HV are given in **Figure 1**. Thanks to Infineon’s proprietary coreless transformer technology, ICL5102/HV’s high-side MOSFET driver is very robust against dV/dt and negative voltage peak in the middle point of the half-bridge, and generates low loss at high operating frequency.

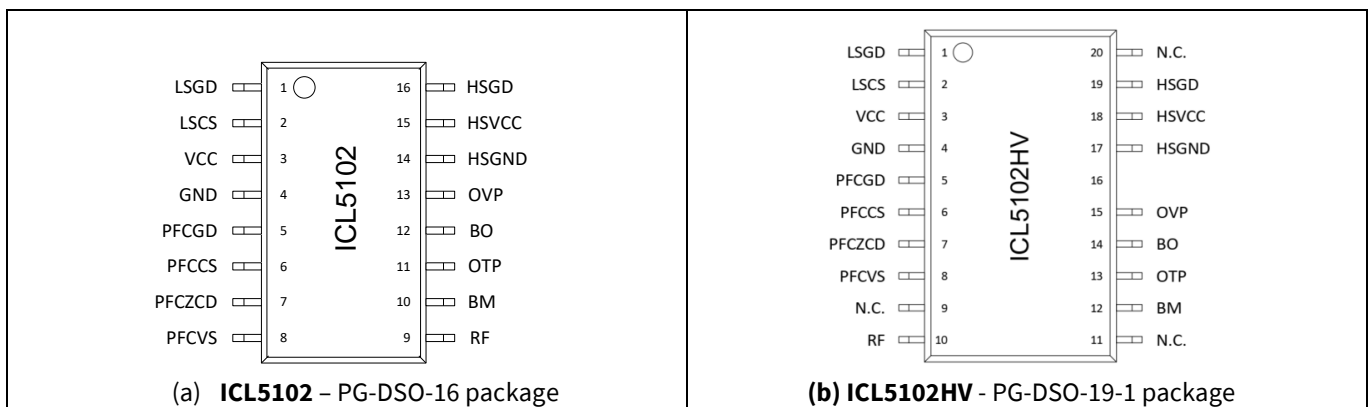

Figure 1 Pin maps of (a) ICL5102 and (b) ICL5102HV

The other key features of ICL5102 are summarized as follows:

Key features:

- Integrated two-stage combo controller allowing for reduced number of external components, optimized Bill of Materials (BOM) and form factor.
- PFC controller with Critical Conduction Mode (CrCM) and Discontinuous Conduction Mode (DCM).
- Resonant HB controller with fixed or variable switching frequency control.
- Maximum 500 kHz HB switching frequency and soft-start frequency up to 1.3 MHz.
- Resonant HB burst mode (BM) ensures power limitation and low standby power of less than 300 mW.
- Supports universal AC input voltage.
- Supports excellent system efficiency.
- THD optimization ensuring low harmonic distortion down to 30 percent nominal load.

Protection mechanisms:

- Input brown-out protection.
- PFC bus overvoltage protection (OVP).
- PFC overcurrent protection (OCP).
- Output OVP, OCP/short-circuit protection.
- Output overpower/overload protection (OPP).
- HB capacitive mode protection.
- Overtemperature protection (OTP).

Board description

2 Board description

This 52 W demonstration board is developed for non-dimmable applications with 198 V AC ~ 264 V AC input voltage and 52 V ~ 20 V LED voltage range. The output current is selectable with a two-channel switch. The system architecture of this design is shown in [Figure 2](#).

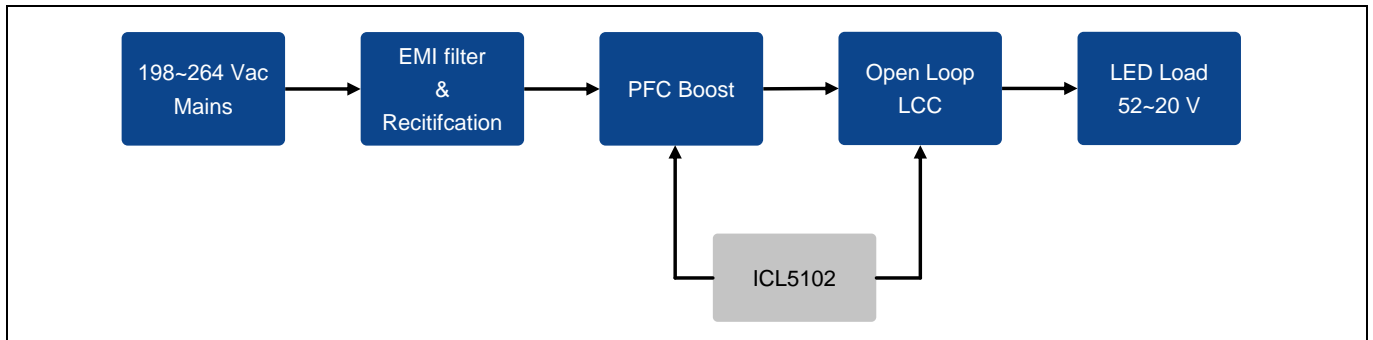

Figure 2 System architecture

Key features of this non-dimmable demonstration board are:

- Low system cost realized with open-loop LCC design and resonant inductor integrated within the LCC transformer.
- LED current tolerance is tightly controlled across a wide temperature range and standard component spread.
- High system efficiency from a dedicated LCC resonant tank design principle for in this non-dimmable application.
- High LCC operating frequency.

2.1 Electrical specifications

Table 1 lists the key electrical specifications of this demonstration board.

Table 1 Key electrical specifications

Parameters	Symbol	Min.	Typ.	Max.	Unit	Remarks
AC input voltage	$V_{in,ac}$	198	220/230	256	V_{RMS}	
Input frequency	f_{in}	47		63	Hz	
Inrush current	$I_{in,pk}$			35	A_{pk}	
Total harmonic distortion	THD			10 percent	–	Full load range and input voltage range
Efficiency	η		92.5 percent		–	At the maximum load
Targeted LED voltage	V_{LED}	20		52	V DC	
LED current setting 1	$I_{LED,s1}$		1000		mA	$V_{LED} = 20 \sim 52 V$ $-20^{\circ}C \sim 100^{\circ}C^1$
Current spread at setting 1	$\Delta I_{LED,s1}$	± 10 percent				
LED current setting 2	$I_{LED,s2}$		880		mA	
Current spread at setting 2	$\Delta I_{LED,s2}$	± 10 percent				$V_{LED} = 26 \sim 52 V$ $-40^{\circ}C \sim 125^{\circ}C^2$
LED current setting 3	$I_{LED,s3}$		780		mA	
Current spread at setting 3	$\Delta I_{LED,s3}$	± 10 percent				
LCC frequency	f_{LCC}	160		270	kHz	
PFC frequency	f_{PFC}	15			kHz	
Brown-out voltage	V_{BO}		180		V AC	
Brown-in voltage			195		V AC	
EMI	EN 55015					
Harmonics	EN 61000-3-2 class C					

¹ IC junction temperature

² IC junction temperature

52 W low-cost two-stage LED driver based on ICL5102

A PFC + open-loop LCC design with tight LED current spread

Board description



2.2 Schematic and layout

The following figures illustrate the schematic and layout of the board, respectively. On the top side of this single-sided PCB only through-hole components are placed. The copper thickness is 70 μm (2 oz).

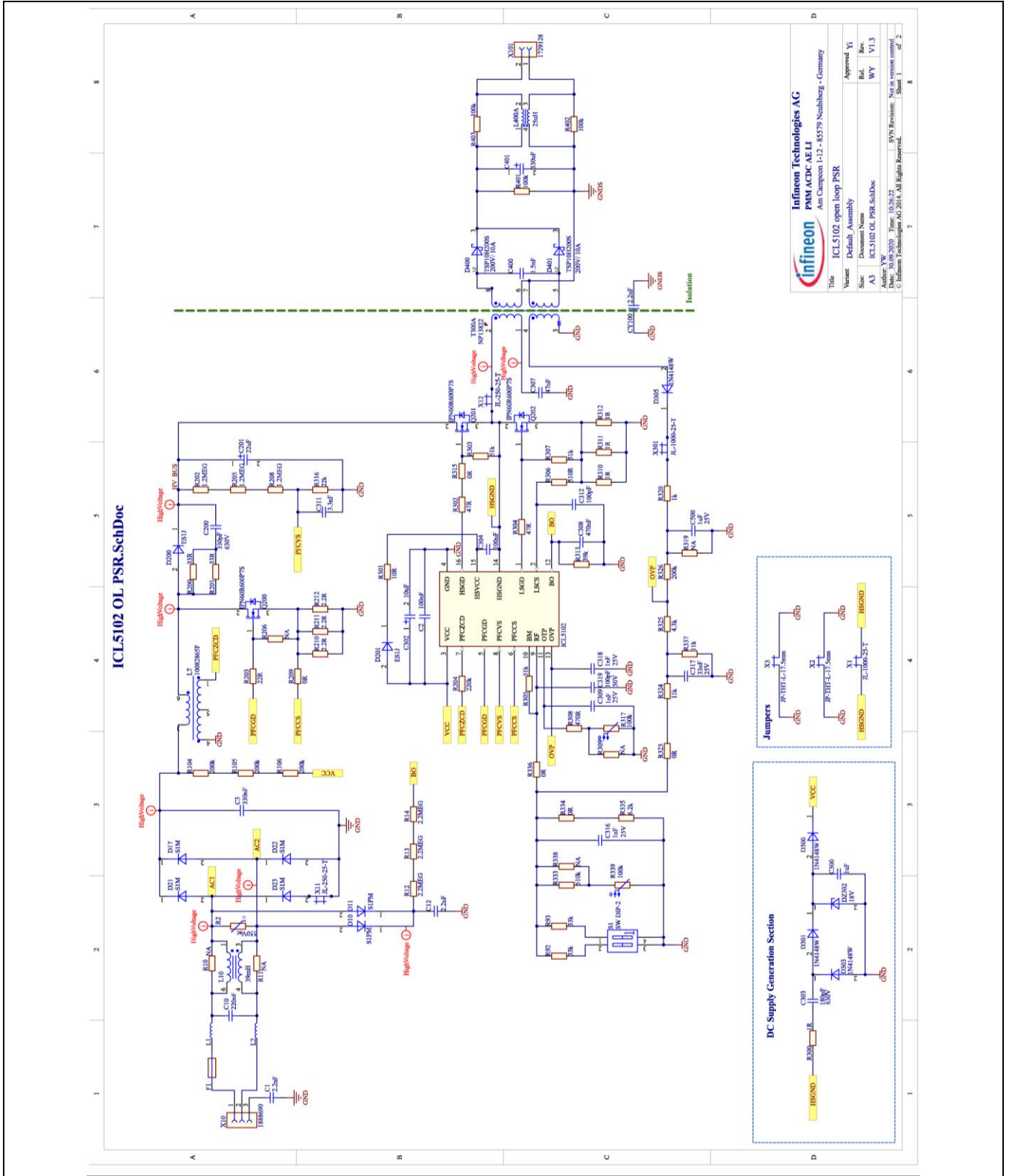

Figure 3 Schematic

2.3 Board setup



Figure 5 Board setup

Electrical performance

3 Electrical performance

This reference board is designed to be a non-dimmable LED driver, with three selectable output current settings that can be configured by a mechanical switch. One important design target is to guarantee the LED current spread is less than or equal to 10 percent over a wide temperature range and a wide LED voltage range within the given component spread. The specified operating area is given in **Figure 6**.

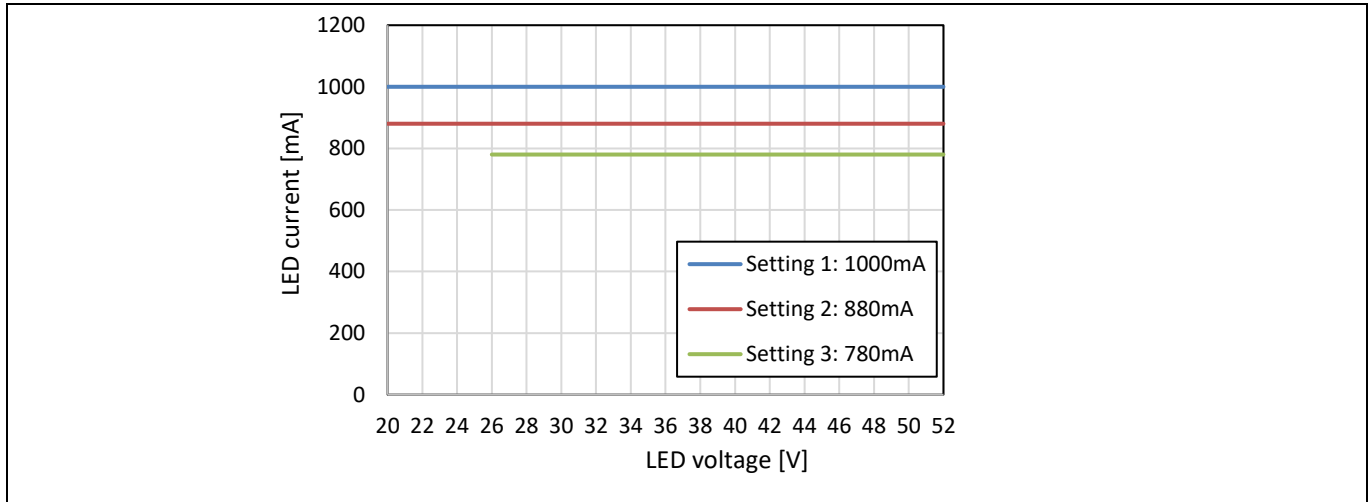

Figure 6 Driver operating windows

The electrical performance of the system, the PFC and the LCC are presented below. Additionally, the LED current spread analysis is also conducted.

3.1 System performance

The system performance in steady-state at three current settings is presented below. They cover the system efficiency at different conditions (Figures 7 and 8), power factor and THD (Figures 9 and 10) and harmonics at two current settings (Figures 11 and 12). The efficiency at maximum load and 230 V AC reaches 92.5 percent.

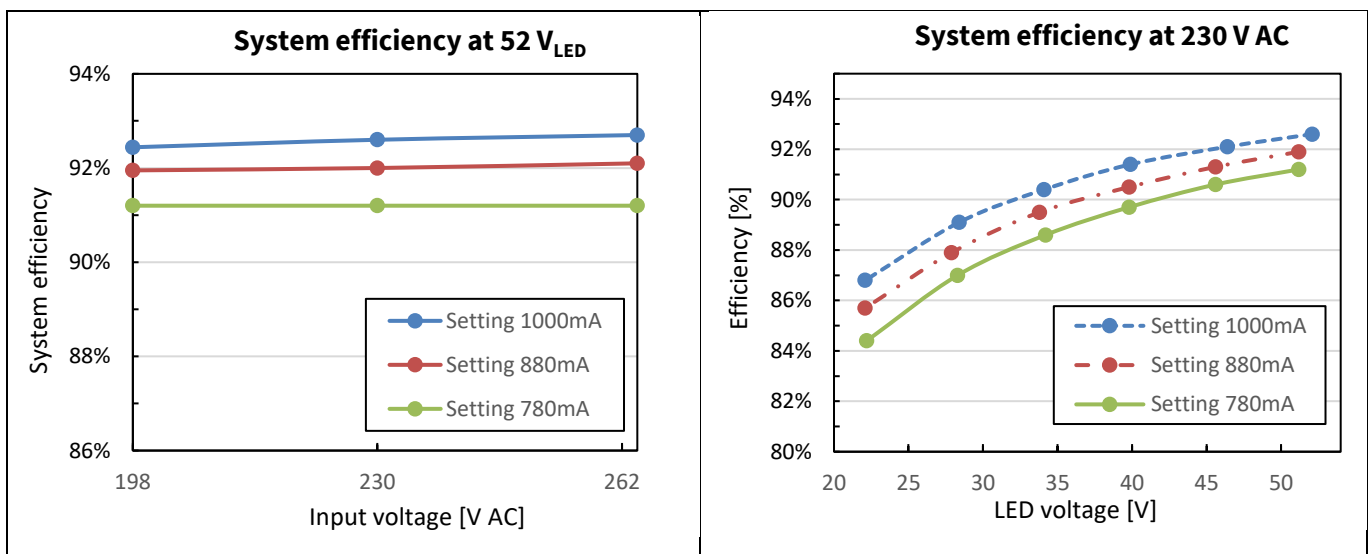

Figure 7 System efficiency at various input voltages and 52 V_{LED}

Figure 8 System efficiency at 230 V AC and various V_{LED}

Electrical performance

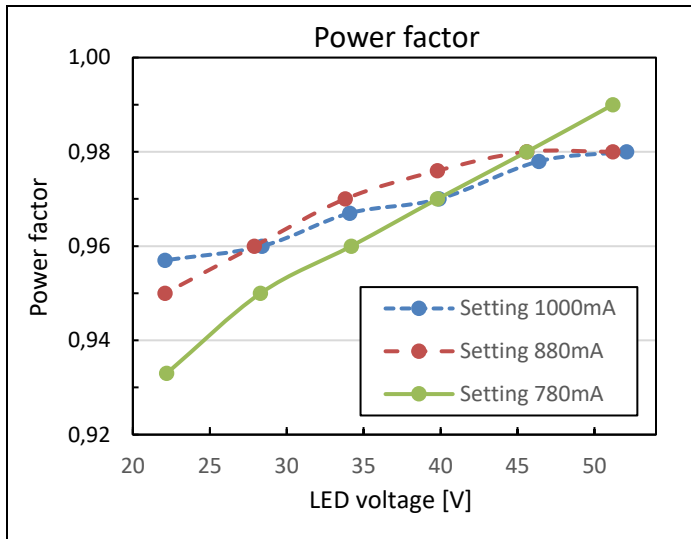

Figure 9 Power factor

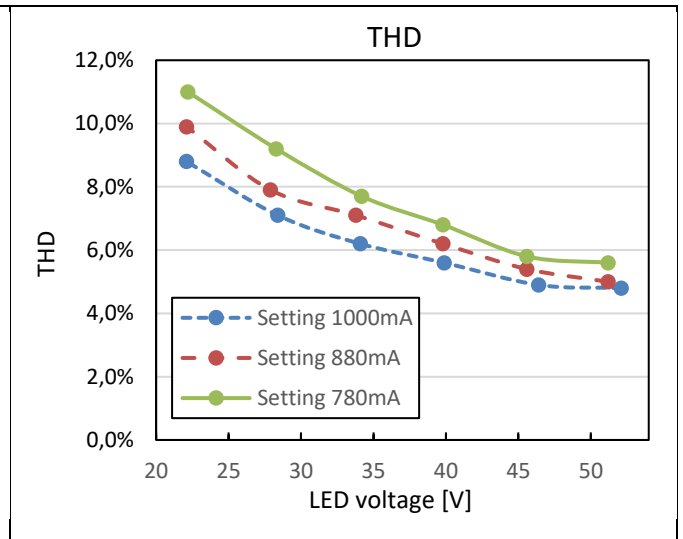

Figure 10 Total harmonic distortion

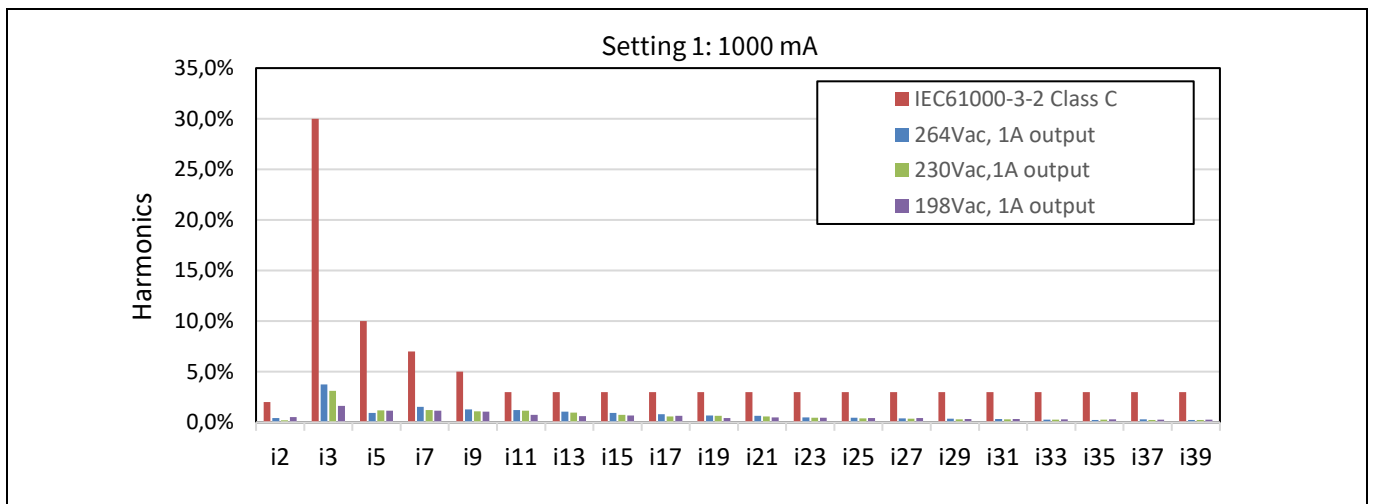

Figure 11 Harmonics measurement at 1000 mA setting

Electrical performance

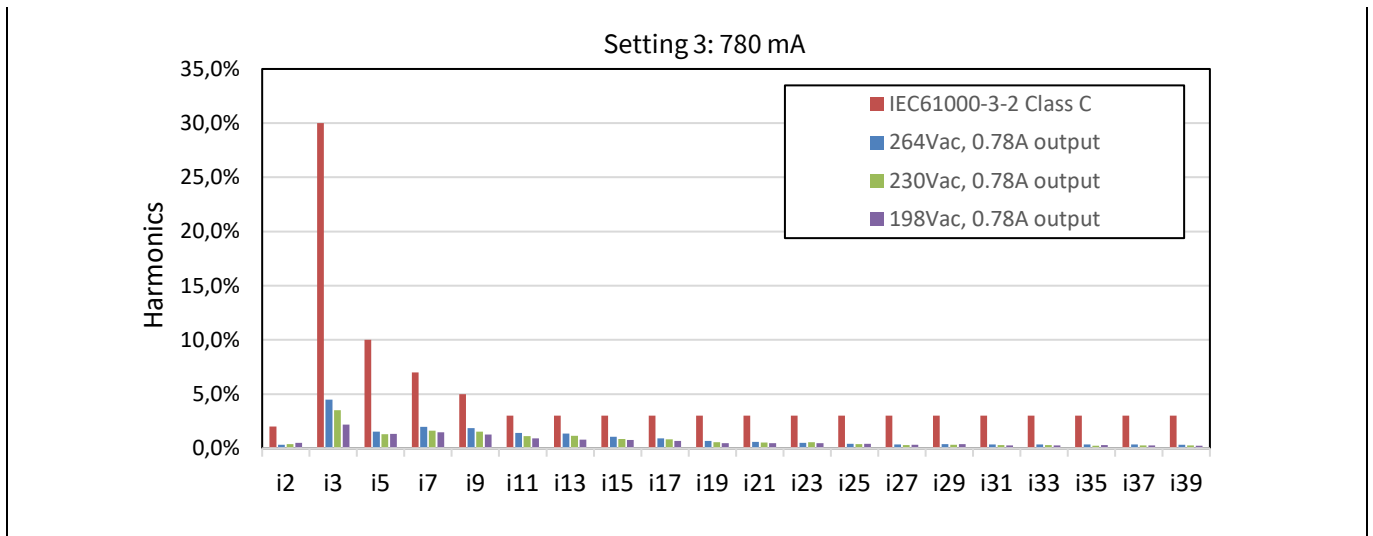

Figure 12 Harmonics measurement at 780 mA setting

The measured LED current at various LED voltages at three current settings is plotted in [Figure 13](#). These measurements are conducted at a room temperature of 23°C.

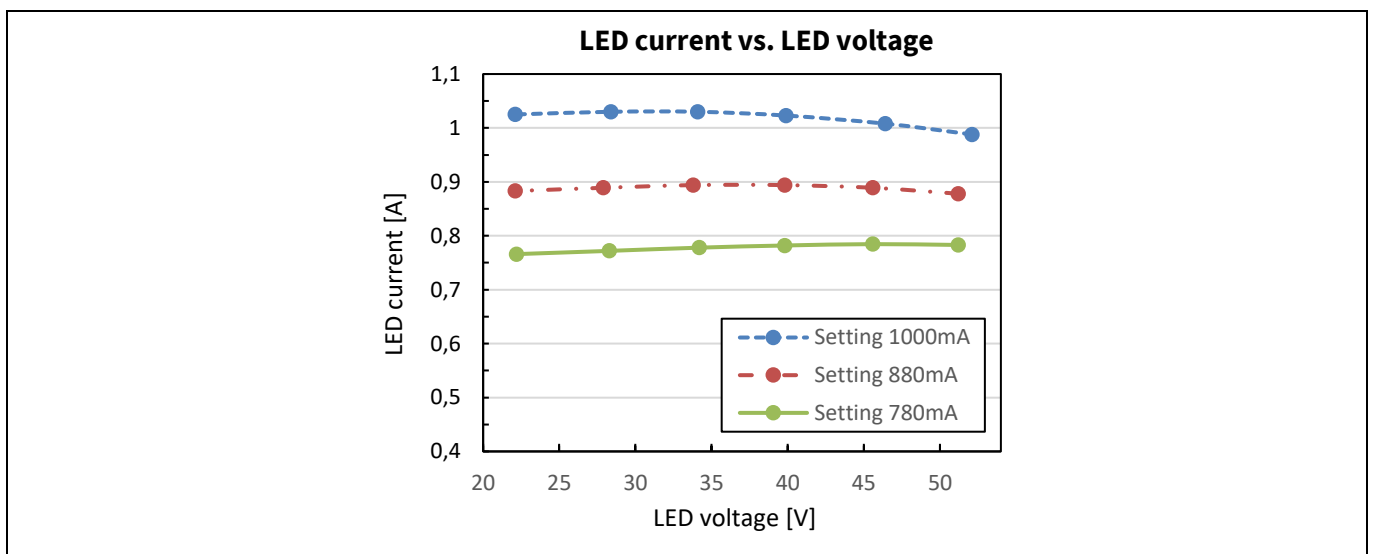

Figure 13 LED current at various LED voltage and current settings

3.2 Startup behavior

This part presents the startup behavior of the driver at various input voltages and loads.

The V_{CC} pull-up resistors and V_{CC} capacitor are selected such that the startup time in the worst case is less than 500 ms (see [Figure 14](#)).

52 W low-cost two-stage LED driver based on ICL5102

A PFC + open-loop LCC design with tight LED current spread

Electrical performance

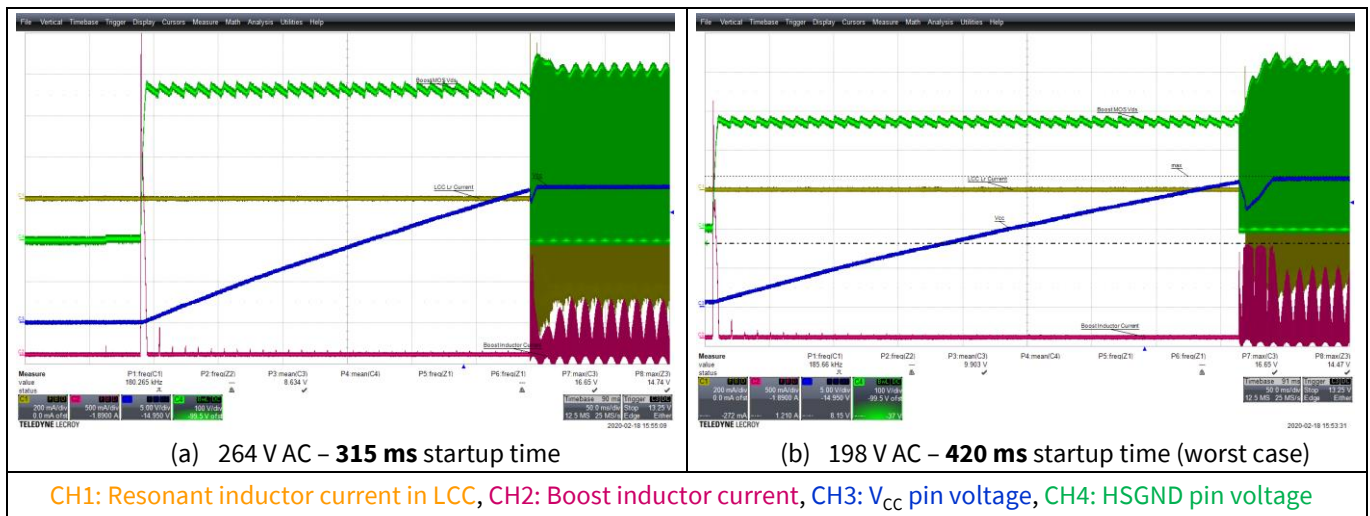

Figure 14 Startup time at (a) 264 V AC and (b) 198 V AC with maximum load

The PFC startup waveforms are given in **Figure 15**. At low mains voltage, the boost inductor current is designed to be clamped to avoid inductor saturation.

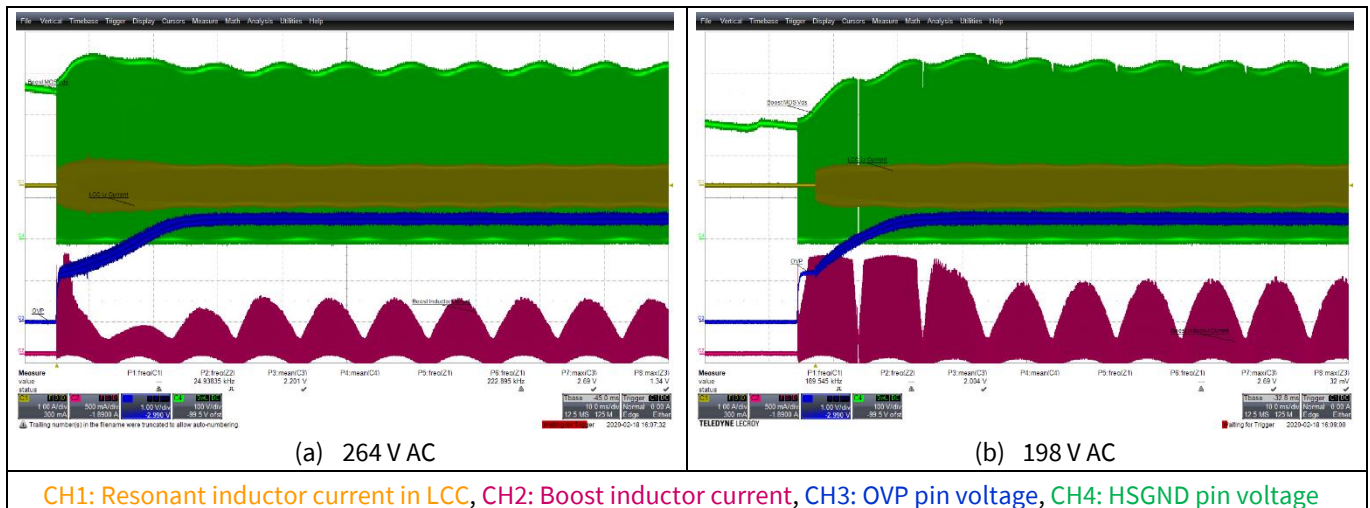

Figure 15 PFC startup behavior at (a) 264 V AC and (b) 198 V AC

3.3 Steady-state

The key waveforms of the PFC and LCC at various input voltages and LED voltages in three current settings are measured and given below in from **Figure 16** to **Figure 19**.

At 264 V AC and 1000 mA current setting, the PFC operates in CrCM across the full LED voltage range. The average operating frequency of LCC is around 190 kHz.

52 W low-cost two-stage LED driver based on ICL5102

A PFC + open-loop LCC design with tight LED current spread



Electrical performance

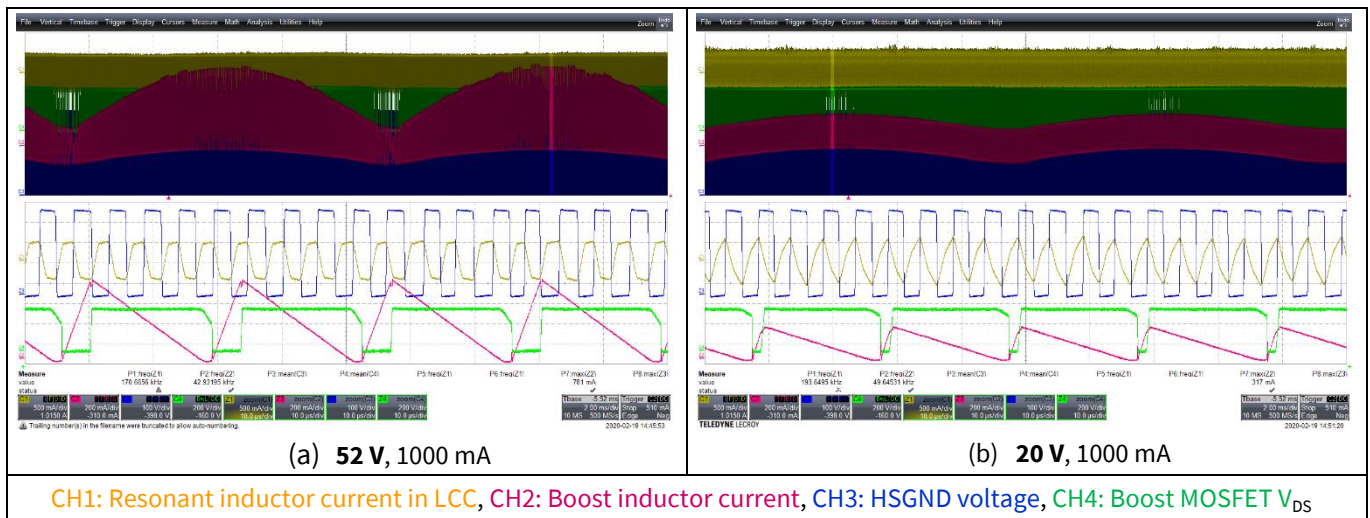

Figure 16 Steady-state waveform at 264 V AC with 1000 mA LED current

At 264 V AC and 880 mA current setting, the PFC operates in CrCM across most of the LED voltage range. At 20 V LED, the PFC operates in DCM (see [Figure 17c](#)) with the minimum operating frequency 17 kHz.

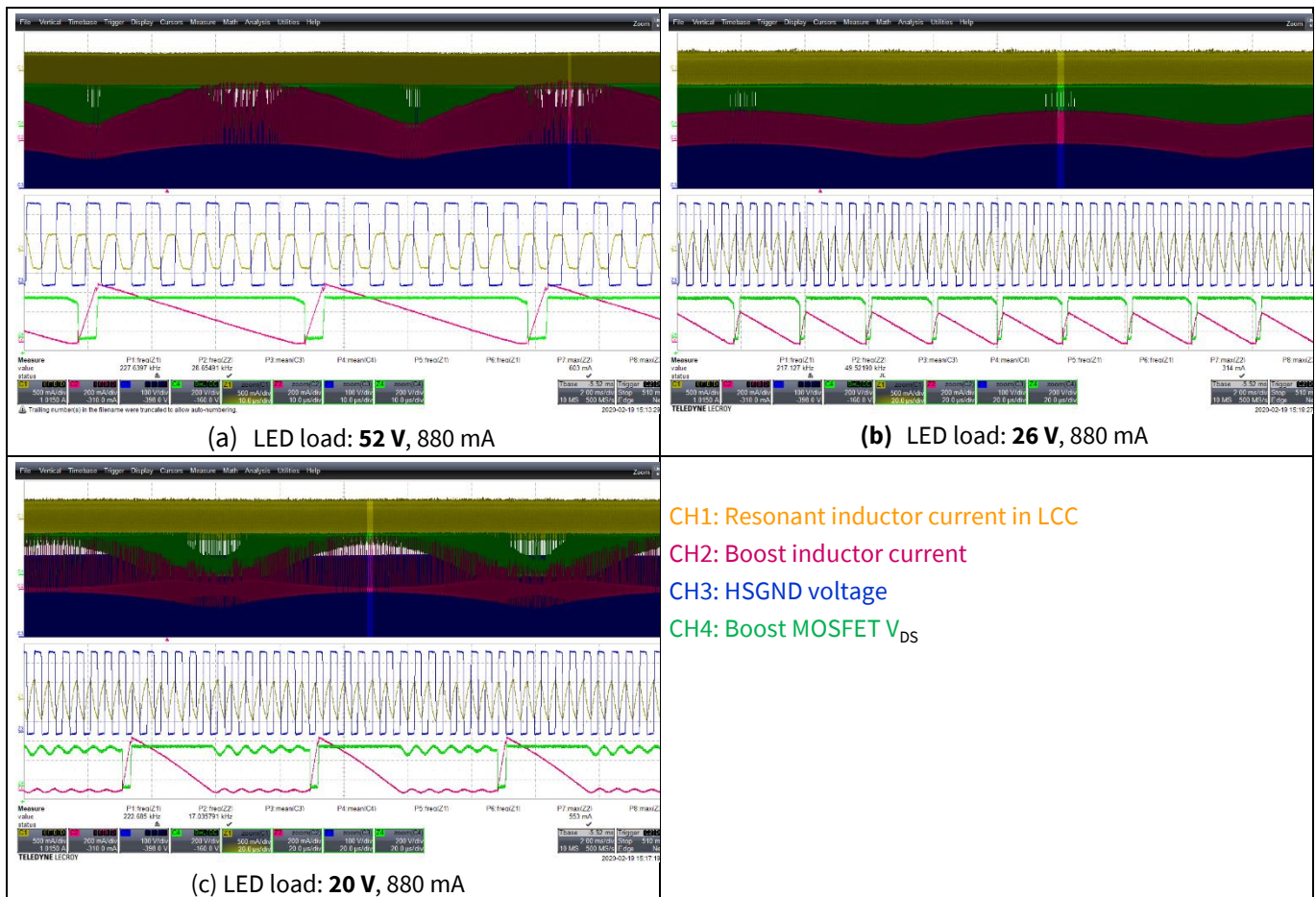

Figure 17 Steady-state waveform at 264 V AC with 880 mA LED current

52 W low-cost two-stage LED driver based on ICL5102

A PFC + open-loop LCC design with tight LED current spread

Electrical performance

At 264 V AC and 780 mA current setting, the PFC operates in CrCM across most of the LED voltage range. At 20 V and 23 V LED, the PFC operates in DCM (see [Figure 18c](#) and [Figure 18d](#)) with the minimum operating frequency of 16 kHz at 20 V_{LED}.

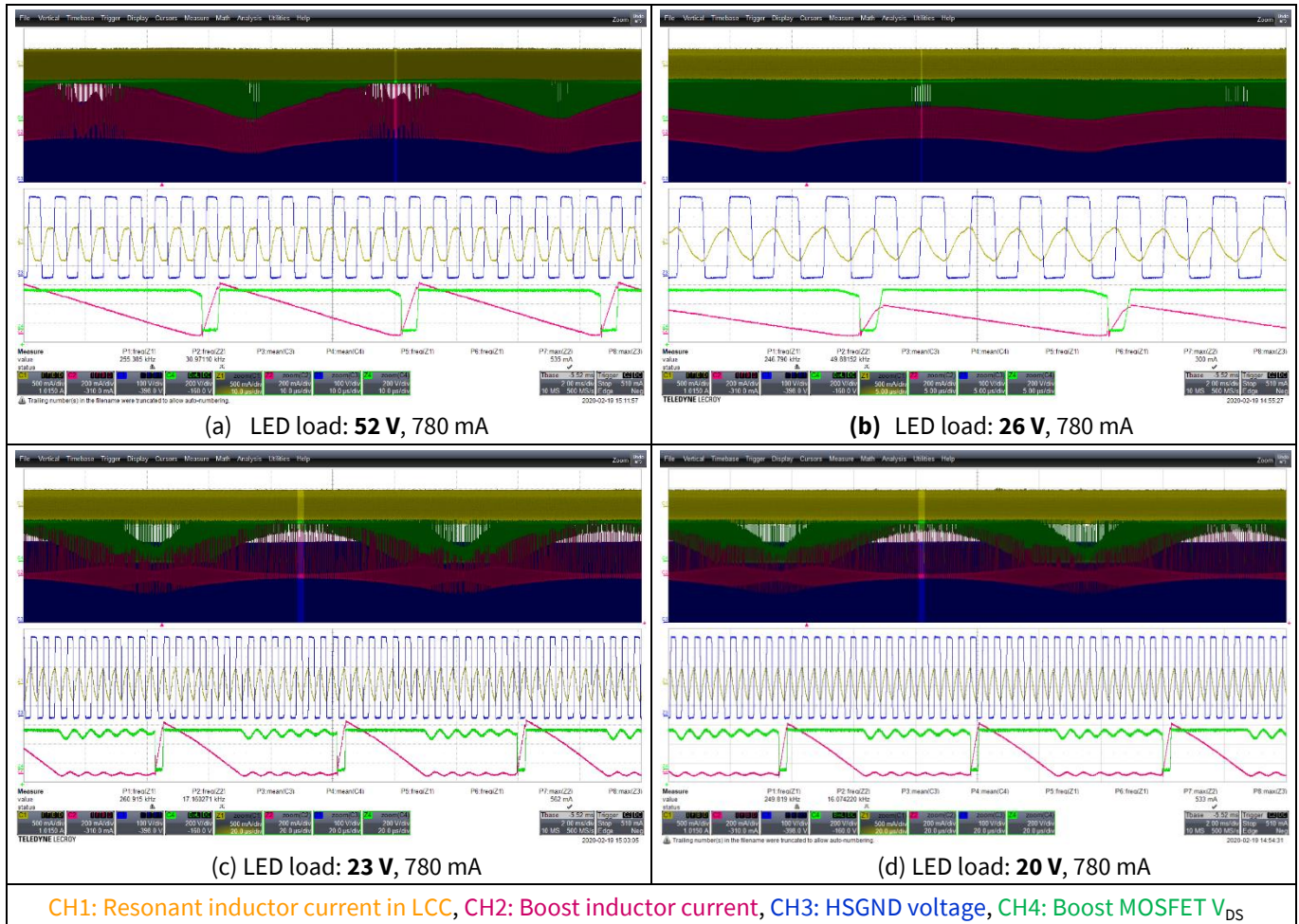

Figure 18 Steady-state waveform at 264 V AC with 780 mA LED current

52 W low-cost two-stage LED driver based on ICL5102

A PFC + open-loop LCC design with tight LED current spread

Electrical performance



With 230 V AC and 198 V AC input, the PFC always operates in CrCM across the full load range (see **Figure 19**).

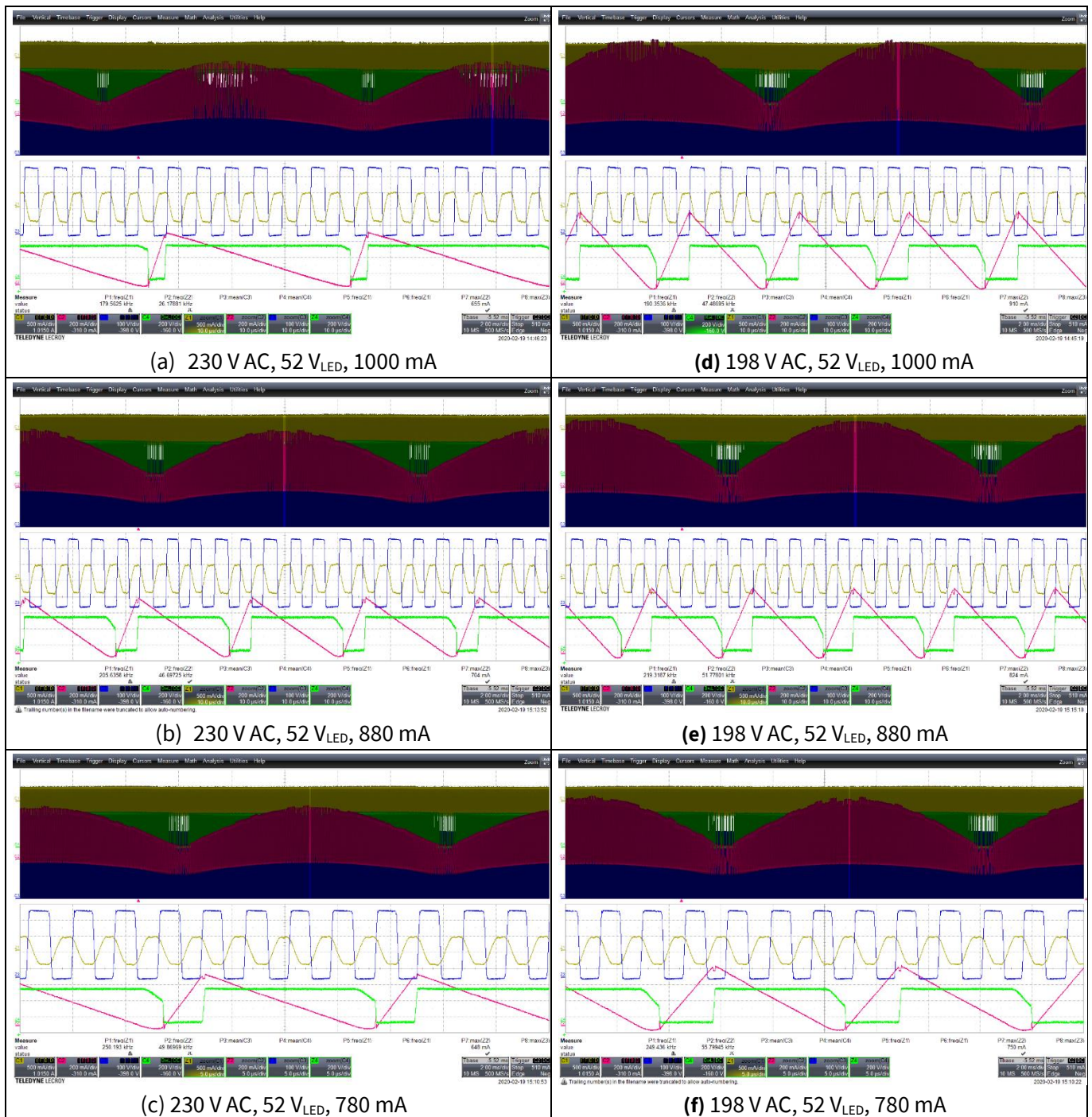

Figure 19 Steady-state waveform at 230 V AC (a, b, c) and 198 V AC (d, e, f)

Electrical performance

The PFC operating frequency at mains peak with 20 V and 52 V LED load is measured and presented in [Table 2](#) and [Table 3](#), respectively.

Table 2 PFC frequency at mains peak with 20 V LED load

PFC frequency at mains peak with 20 V LED	264 V AC	230 V AC	198 V AC
1000 mA	42.9 kHz	78 kHz	83 kHz
880 mA	17 kHz (DCM)	84 kHz	91 kHz
780 mA	16 kHz (DCM)	90 kHz	98 kHz

Table 3 PFC frequency at mains peak with 52 V LED load

PFC frequency at mains peak with 52 V LED	264 V AC	230 V AC	198 V AC
1000 mA	27 kHz	43 kHz	48 kHz
880 mA	29 kHz	49 kHz	53 kHz
780 mA	32 kHz	53 kHz	58 kHz

The LCC operating frequencies measured at different power settings are listed in [Table 4](#).

Table 4 LCC operating frequency at different LED voltage and current settings

LCC frequency	1000 mA	880 mA	780 mA
52 V _{LED}	171 kHz	228 kHz	244 kHz
20 V _{LED}	194 kHz	256 kHz	265 kHz

3.4 Protections

This section presents the results of brown-out protection and OVP.

3.4.1 Brown-out protection

[Figure 20](#) shows that the driver triggers brown-out protection when the input voltage drops to 182 V AC and the driver recovers operation at 196 V AC.

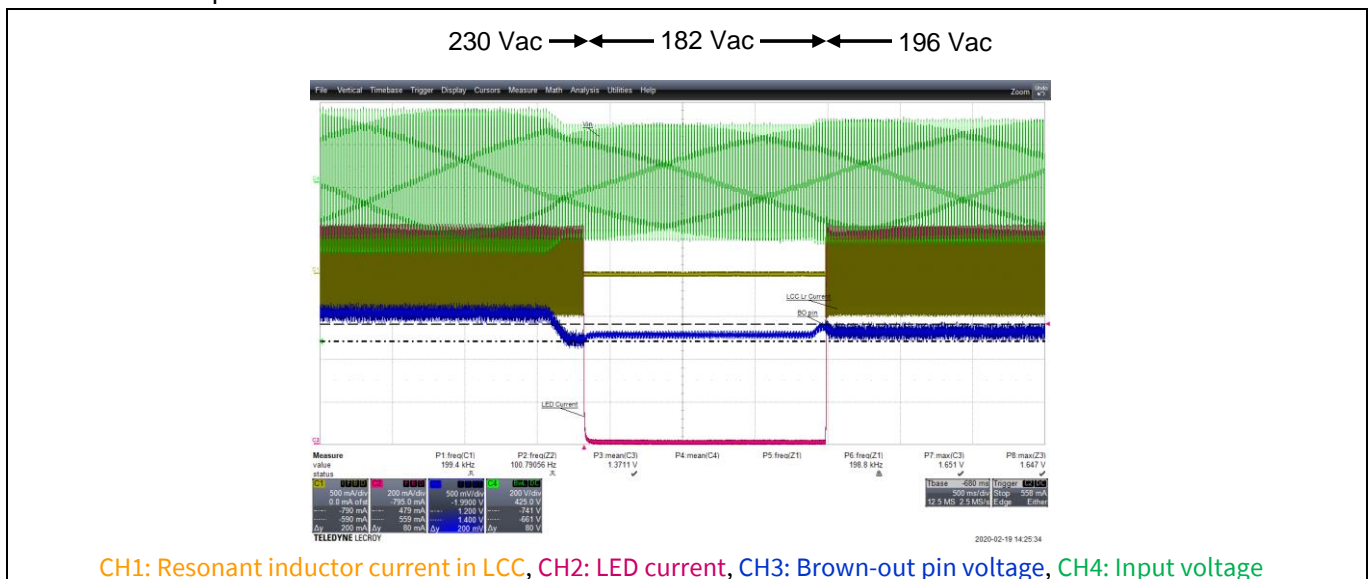

Figure 20 Brown-out protection

3.4.2 Output OVP

Figure 21 shows the output OVP when the 52 V LED is disconnected and reconnected. The auto-recovery time is around 500 ms after OVP pin voltage hits 2.5 V.

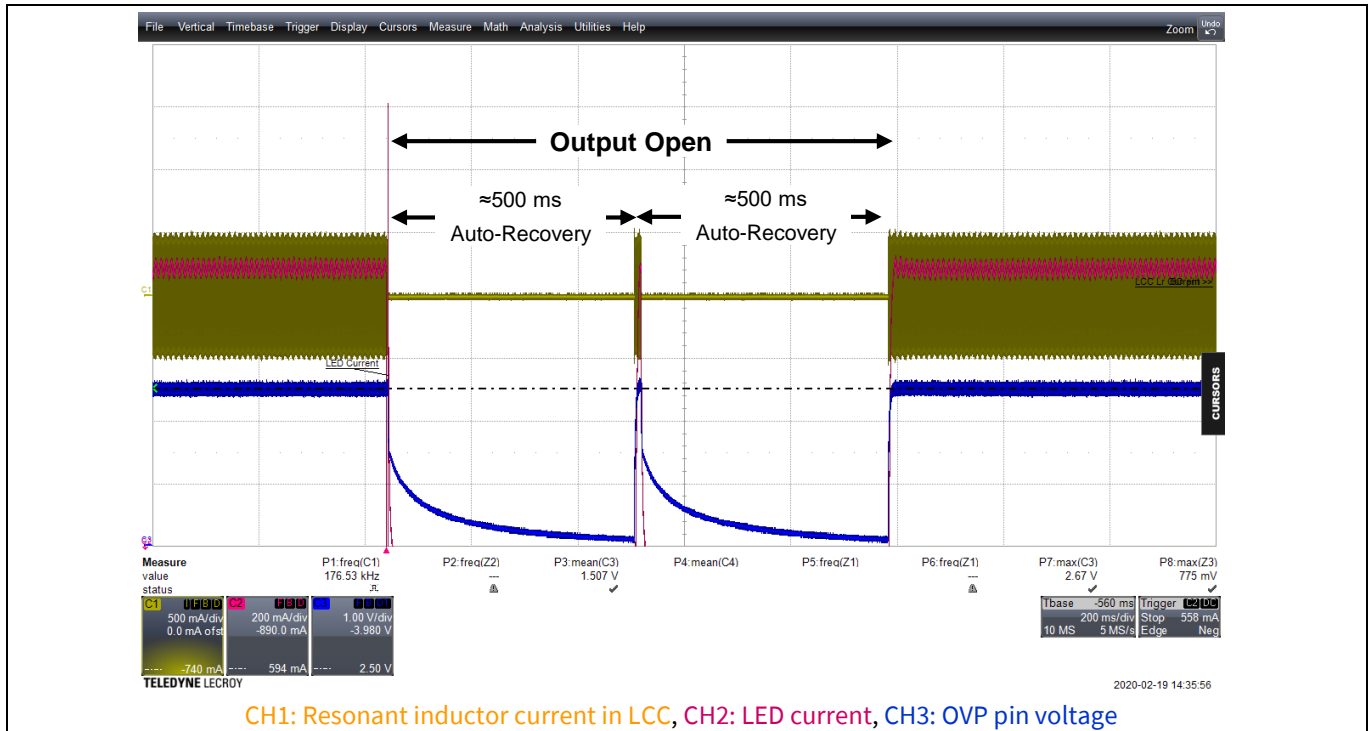

Figure 21 Output OVP

3.5 LED current spread analysis

To reduce the cost of the non-dimmable driver design, open-loop control is one solution that omits the expensive optocoupler used in closed-loop control. However, the LED current spread should be well constrained for a consistent light flux.

Electrical performance

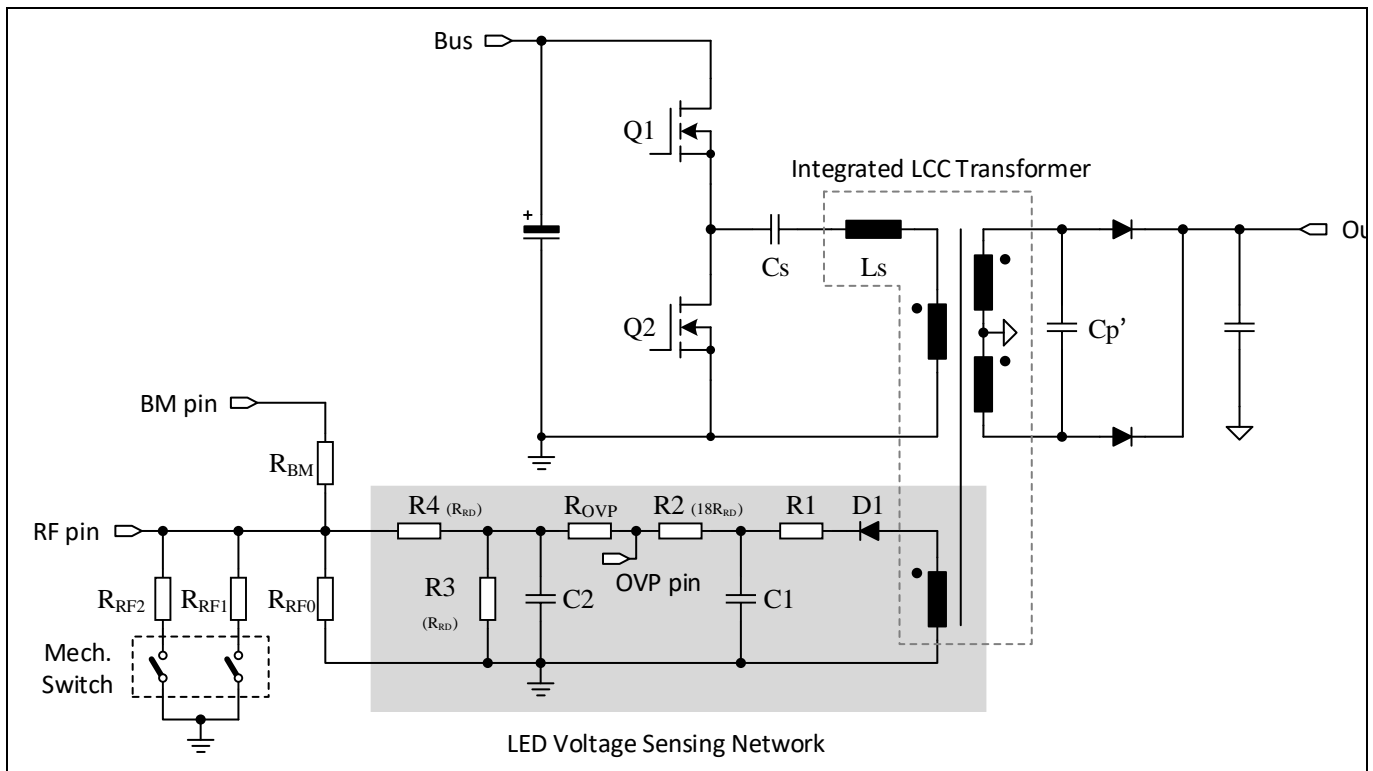

Figure 22 LED current feed-forward compensation from a LED voltage sensing network

If the operating frequency is set only by the resistors R_{BM} and R_{RFx} (see [Figure 22](#)), the output current will be dependent on the LED voltage. The dashed curve in [Figure 23](#) shows that lower LED voltage results in a higher LED current, and the influence of varied LED voltage easily deviates the current beyond 10 percent specified tolerance, even without considering the component spread. To limit the LED current dependency on the LED voltage range in the open-loop design, a feed-forward compensation on LED current is implemented by a LED voltage sensing network (see [Figure 22](#)). Here, an auxiliary winding must be tightly coupled to the secondary windings so as to obtain the accurate LED voltage information. In the integrated LCC transformer of this design, a two-segmented bobbin is utilized for sufficient leakage inductance. The auxiliary winding with a triple isolated wire is wound in the bobbin segment containing two secondary windings and ends back in the segment with the primary winding. In [Figure 22](#), D1, R1 and C1 form a network to rectify the AC voltage and damp possible oscillation from parasitic inductance and capacitance. Three subsequent resistors, R2, R3 and R4, tune the frequency sensitivity to the measured LED voltage. Here, R2 is 18 times R3 and R4, which is calculated from the LED maximum voltage and the choice of turns ratio between the secondary winding and the auxiliary winding. R_{OVP} value is much smaller than R2 and R3, which is just slightly tuned for the correct OVP detection.

Simulation has been carried out to investigate the sensitivity of LED current to the LED voltage, in terms of R_{RD} value. Here, $R2 = R3 = R_{RD}$. To reach the specified LED current, the set frequency (f_{set}) formed only by R_{BM} and R_{RFx} is settled at 160 kHz, 195 kHz and 225 kHz, which can be switched by a mechanical switch. [Figure 23](#) and [Figure 24](#) plot the simulated sensitivity at different set frequencies in relation to the R_{RD} value. Conclusions from these simulations are:

1. The LED sensing network is able to effectively reduce the sensitivity of LED voltage on LED current.
2. $R_{RD} = 11 \text{ k}\Omega$ is the best choice to flatten the LED current sensitivity over the current settings. The best R_{RD} value can be different only if single current setting is used in the application.

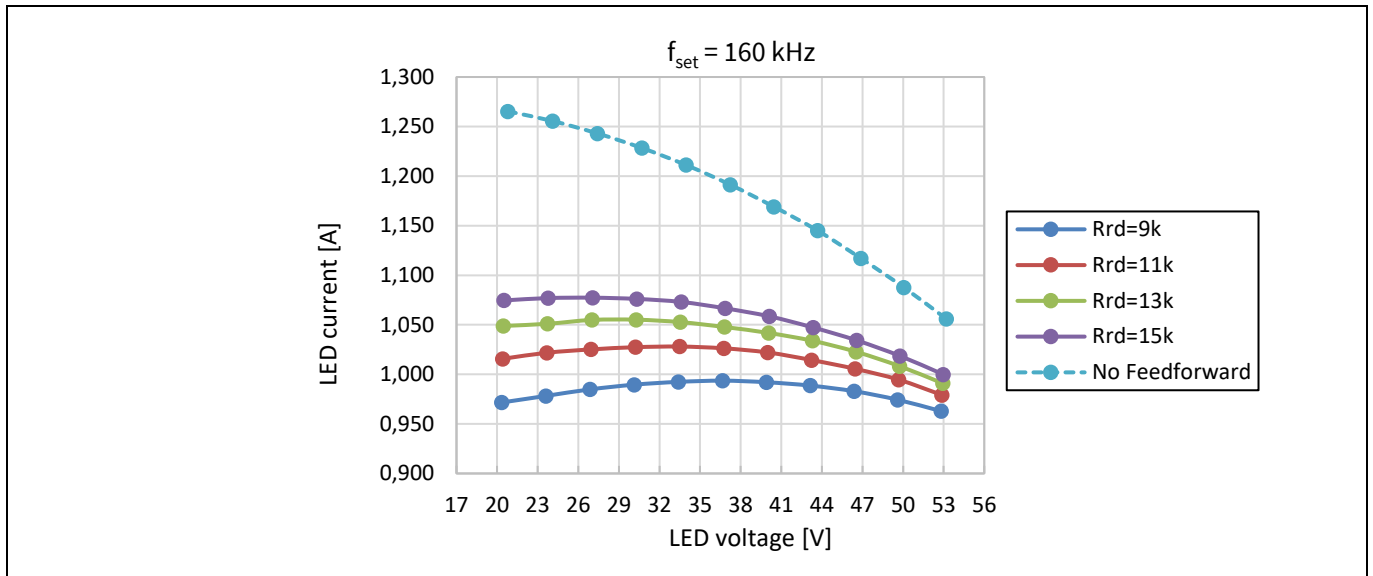

Figure 23 LED current sensitivity simulation in relation to R_{RD} value - f_{set} = 160 kHz

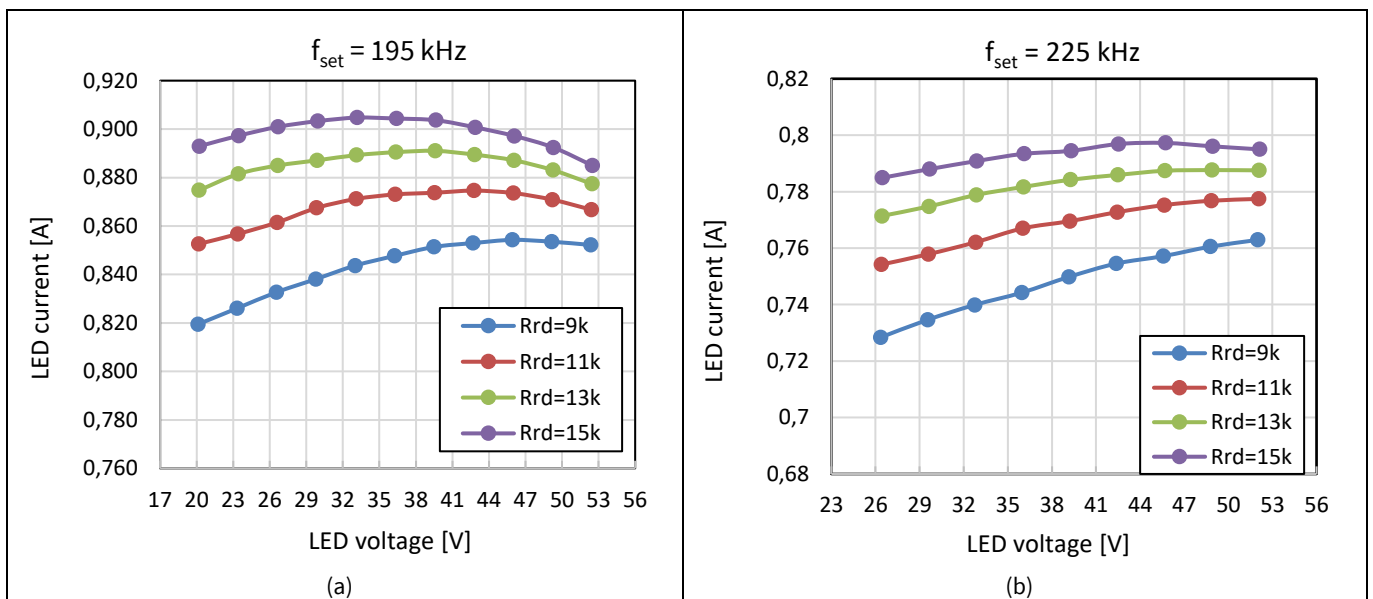

Figure 24 LED current sensitivity simulation in relation to R_{RD} value (a) f_{set} = 195 kHz and (b) f_{set} = 225 kHz

Figure 25 shows the validity of the simulations above.

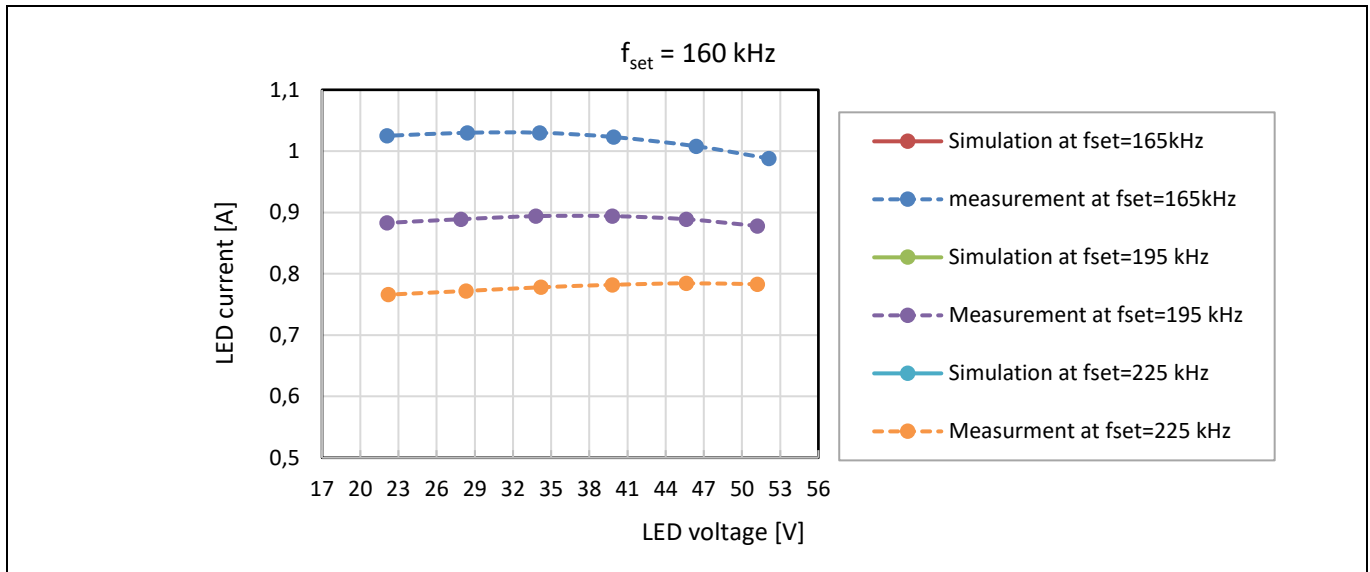

Figure 25 Measurement and simulation comparison

Based on the verified simulation model, the LED current spread has been analyzed based on key component tolerances listed in Table 5. The assumption made here is that all component tolerances follow a normal distribution pattern.

Table 5 Component tolerances considered in Monte Carlo analysis for LED current spread

Component	Tolerances	Specified standard deviation	Remarks
Series resonant capacitor (Cs)	±5 percent	3 σ	- Film capacitor
Series resonant inductance (Ls)	±5 percent, ±7 percent, ±10 percent	3 σ	- 5 percent, a standalone inductor - 10 percent, using leakage inductance of a transformer as the resonance inductor
Parallel resonant capacitor (Cp')	±5 percent	3 σ	- Film capacitor
Resistors	±1 percent	3 σ	- SMD resistor
Frequency as functions of RF pin current	±5 percent	4 σ	- For frequency of less than 210 kHz
	±7 percent	4 σ	- For frequency of less than 270 kHz and IC temperature greater than -20°C
Bus voltage	±2 percent	3 σ	- Considering the resistive divider and IC tolerances

In the following analysis, the leakage inductances of the transformer are categorized into three groups: ±5 percent, ±7 percent and ±10 percent. ±5 percent represents a typical inductance tolerance when a discrete inductor is used as the resonance inductor, while ±10 percent represents the typical tolerance where an integrated LCC transformer is implemented. When special care is taken in an integrated transformer design (for example, the windings take an integer number of layers which avoids the leakage inductance variance due to the winding movement in the half-full layer), the leakage inductance can be controlled more tightly than ±10 percent, therefore, ±7 percent is also considered here. The leakage inductance of 50 integrated transformer

52 W low-cost two-stage LED driver based on ICL5102

A PFC + open-loop LCC design with tight LED current spread



Electrical performance

samples haven't been tested. Their average inductance, maximum and minimum values and 3-sigma spread have been measured and calculated. **Table 6** presents the statistics of these 50 integrated transformers, where the 3-sigma tolerance of the leakage inductance is 2.84 percent and 1.91 percent for two secondary windings. These transformers are from one product lot. We assume that this value is 7 percent when the lot number increases.

Table 6 Statistics of the leakage inductance of 50 integrated LCC transformer samples

Parameters	Secondary winding 1	Secondary winding 2
Average leakage inductance*	443.8 μ H	435 μ H
Maximum inductance	453.9 μ H	443.3 μ H
Minimum inductance	429.2 μ H	427.3 μ H
Standard deviation	4.2 μ H	2.8 μ H
3-sigma tolerance**	2.84 percent	1.91 percent

* Measured from primary with one secondary winding shorted and the other one open

** Calculated by $3 \times \text{standard deviation} / \text{average value} \times 100$ percent

To minimize the LED current spread over the frequency spread caused by the controller IC, the LCC resonance tank must be designed in a special way before the tolerance analysis. The general principle is to make the current gain curve (as a function of frequency) as flat as possible. Here, since this is a non-dimmable design, we do not need to think about the maximum frequency that IC can support at the dimming case.

The selected LCC resonance tank parameters are shown below:

Table 7 LCC resonance tank parameters

LCC resonance tank parameters	Values
Series resonant capacitor (C_s)	47 nF
Series resonant inductance (L_s)	440 μ H
Parallel resonant capacitor (C_p') at the secondary side	1.5 nF

In the Monte Carlo simulation, 1600 runs have been done for each current setting and each L_s tolerance group to explore the entire defined tolerance range. The LED current points are plotted in **Figure 26** in terms of the actual LCC frequency and in three different output current settings and full LED voltage range, where the series resonant current tolerances are defined to be ± 10 percent, ± 7 percent and ± 5 percent with 3σ deviation. In **Figure 26**, the actual LCC frequency spread can be also found. For 1000 mA setting, the LCC frequency is mostly below 210 kHz.

Electrical performance

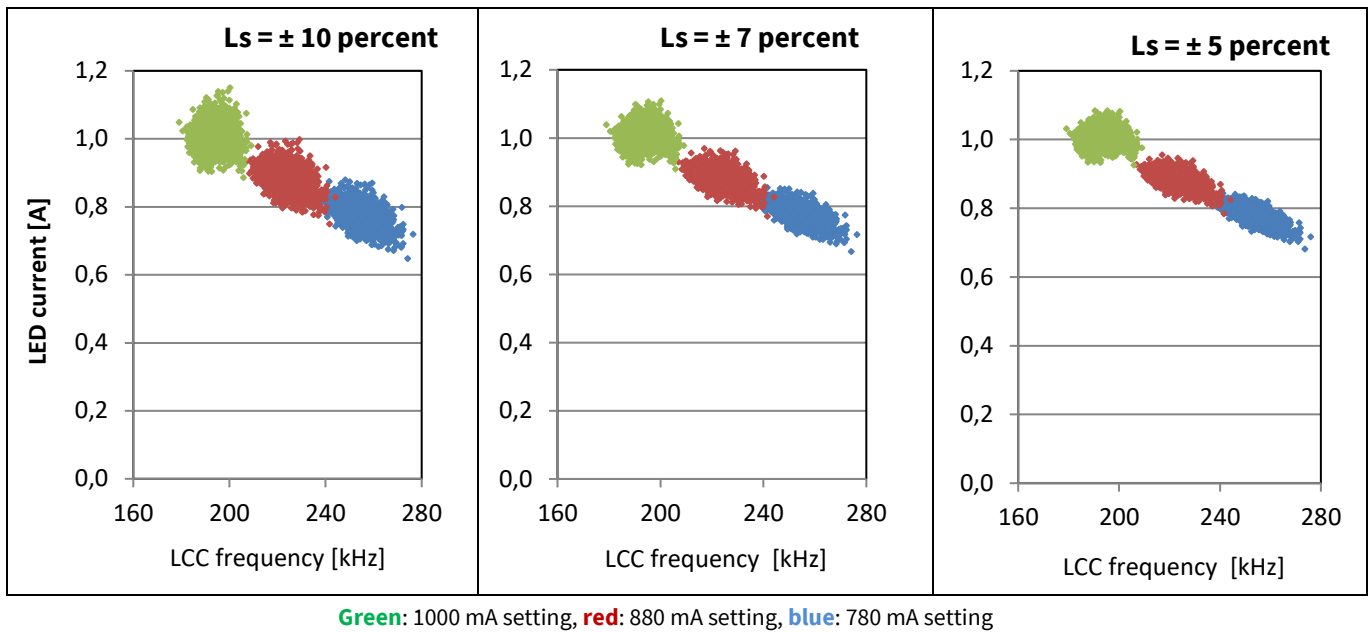

Figure 26 LED current points in 1600 Monte Carlo simulation runs in specified component tolerance range in [Table 5](#).

The LED current spread with different series inductance tolerance groups and three current settings are analysed and shown in [Table 8](#). These results show that when $L_s = \pm 7$ percent, the LED current spread is successfully controlled within ± 10 percent defined in the specification. Note that ± 10 percent is normally the typical tolerance of the leakage inductance of a wire-wound transformer, while ± 5 percent is a typical inductance of a discrete inductor.

Table 8 LED current spread analysis at different current settings and series inductance tolerance groups

Current settings	$L_s = \pm 10$ percent	$L_s = \pm 7$ percent	$L_s = \pm 5$ percent
1000 mA setting*	± 11.2 percent	± 8.7 percent	± 7.3 percent
880 mA setting	± 11.8 percent	± 9.4 percent	± 7.9 percent
780 mA setting**	± 13 percent	± 9.96 percent	± 9.2 percent

* IC frequency spread here is ± 5 percent because the switching frequencies are below 210 kHz

** In this setting, the specified LED voltage is down to 26 V

[Figure 27](#) shows the simulated LED current distribution at three current settings, where all component tolerances listed in [Table 5](#) have been considered in the Monte Carlo simulation.

Electrical performance

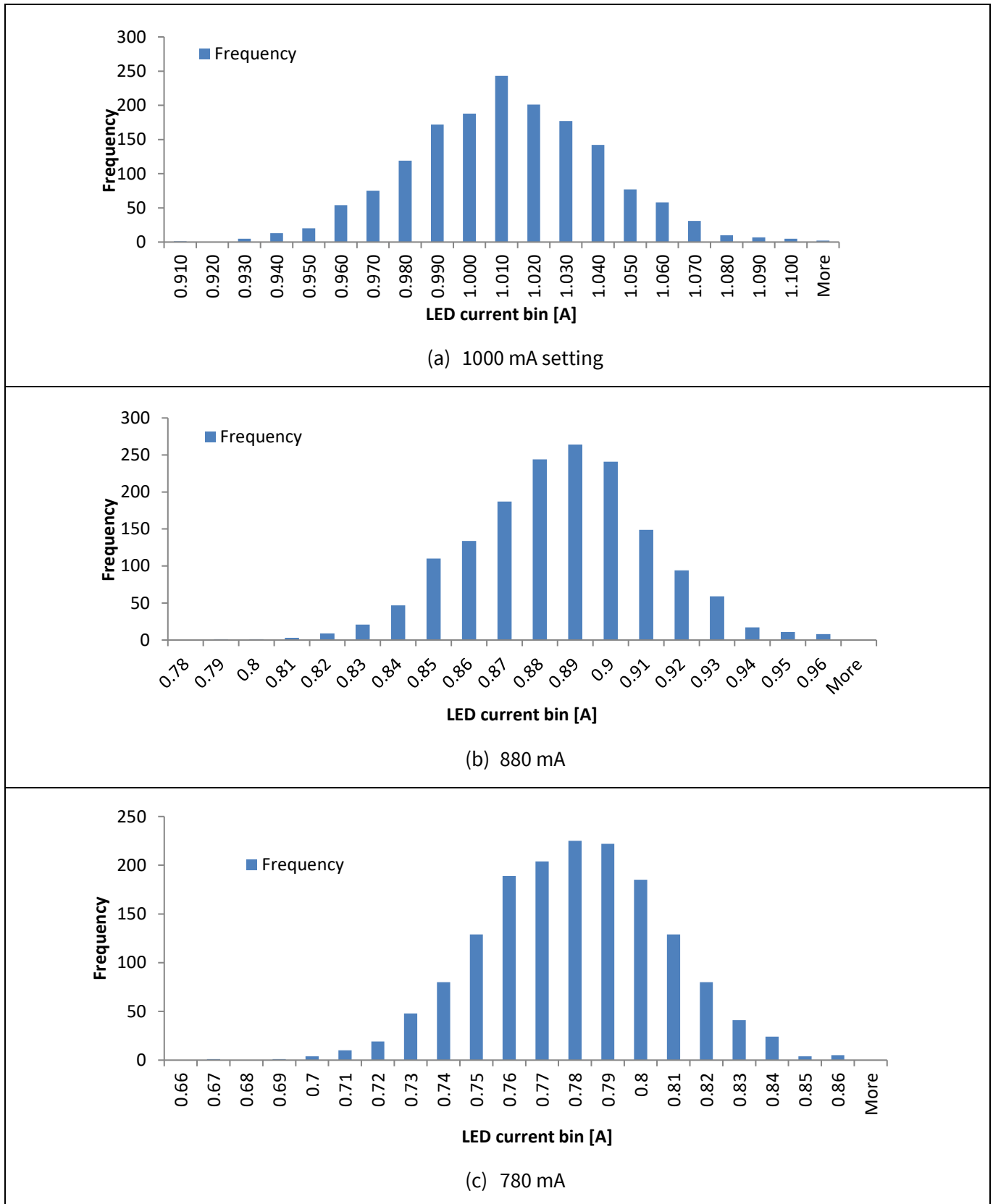

Figure 27 Simulated LED current distribution with $L_s = \pm 7$ percent and at (a) 1000 mA, (b) 880 mA and (c) 780 mA current settings

4 Thermal performance

Figure 28 shows the infrared picture of the board at nominal input and full load, namely 230 V AC input and 100 mA/52 V LED, with 23°C room temperature and free air condition.

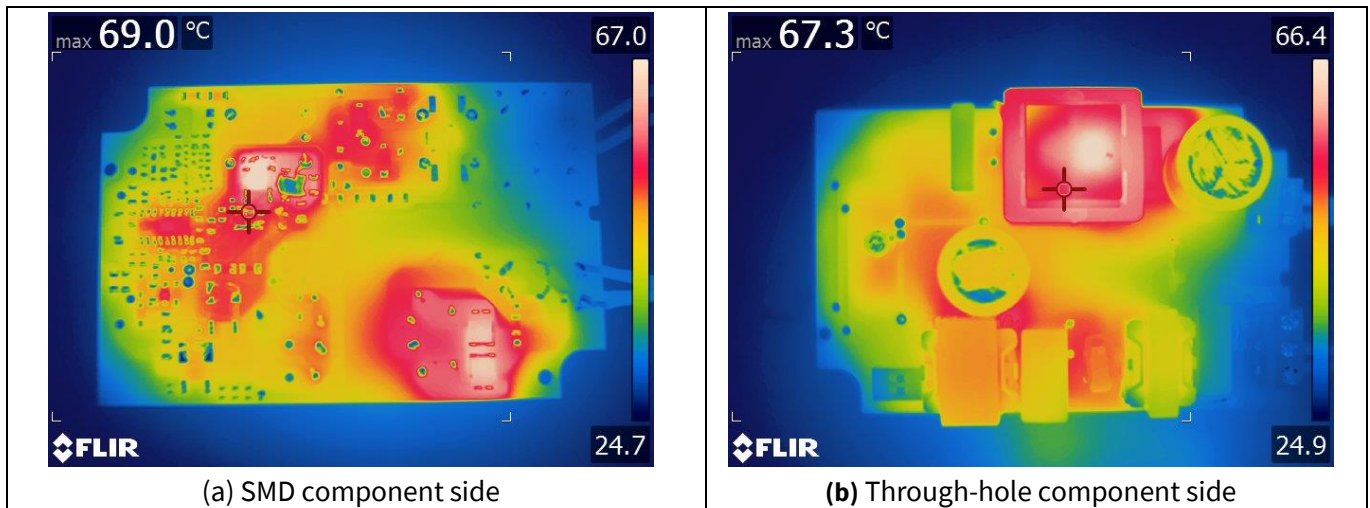

Figure 28 Thermal at nominal condition: 230 V AC, 52 V_{LED} and 1000 mA (23°C room temperature and free air)

Figure 29(a) shows the thermal situation when the input is maximum (264 V AC) with full load. The boost MOSFET reaches 72.6°C. **Figure 29(b)** shows the temperature profile when the input is 264 V AC. Here, the load is low with 880 mA, 23 V_{LED}, but the PFC operates in DCM, similar to **Figure 17(c)**.

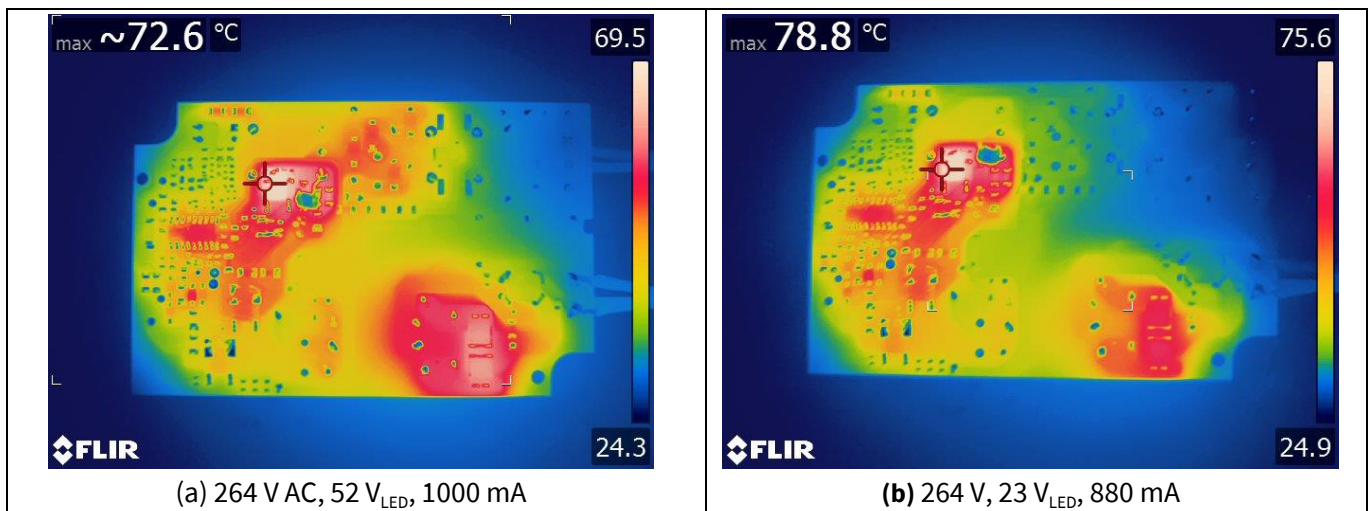
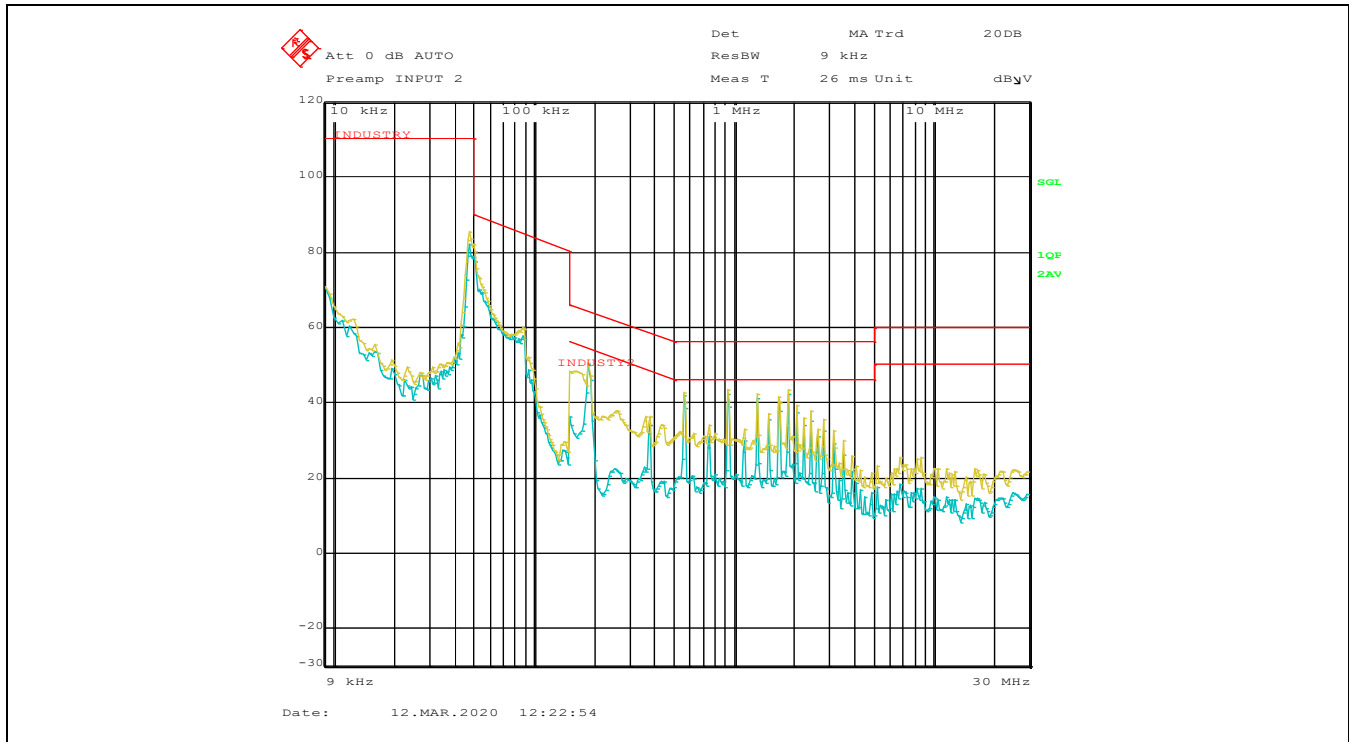

Figure 29 Worst thermal case (23°C room temperature and free air)

EMI

5 EMI

The figures below show the conducted EMI at 1 A, 52 V_{LED} and 0.78 A, 26 V_{LED}. In the latter case, the PFC runs in DCM.



Full load – 230 V AC, 52 V_{LED}, 1 A

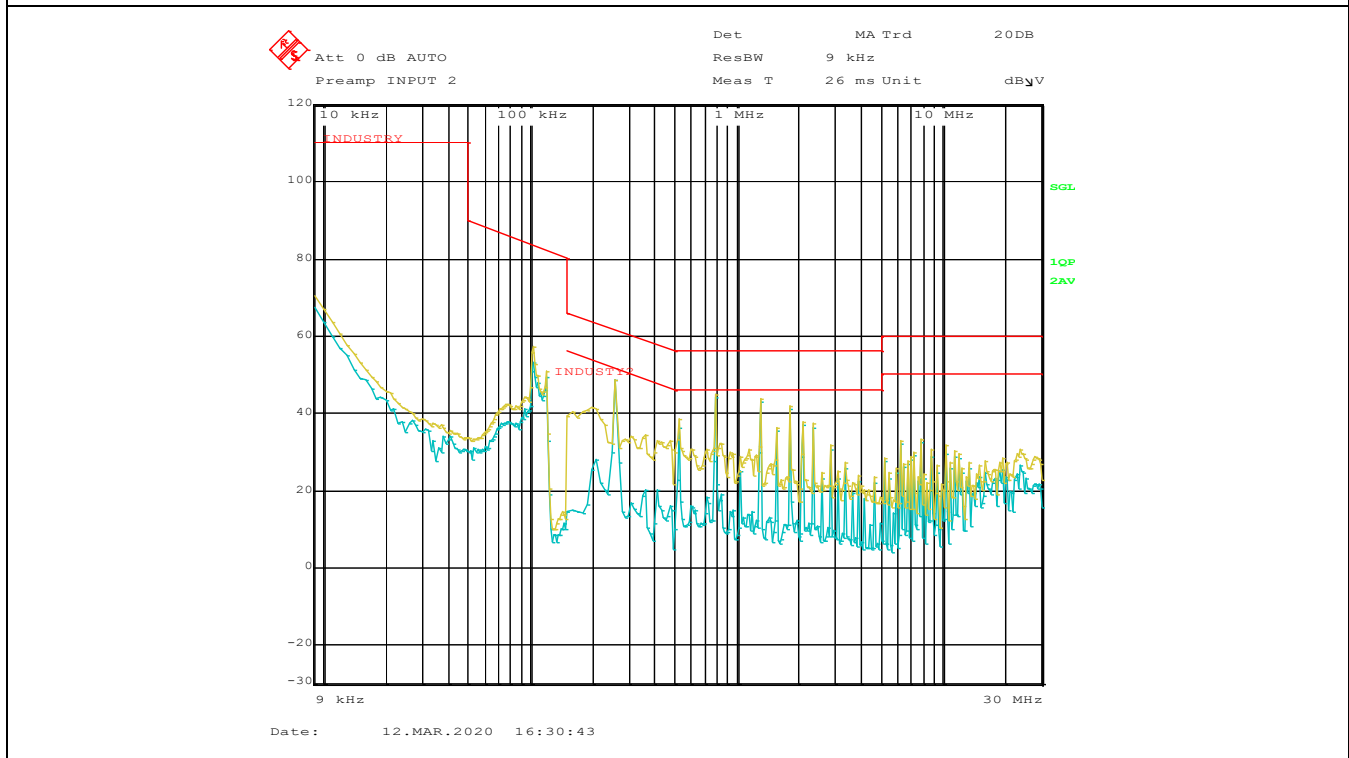

Minimum load – 230 V AC, 26 V_{LED}, 780 mA

6 Magnetic component datasheets

The datasheets of the common-mode EMI filter, boost inductor and LCC transformer are given below.

Common mode filter (L10):

珠海科德电子有限公司 INTELLIGENT COMPONENTS TECHNOLOGY ZHUHAI LTD. (CHINA)	CUSTOMER :	INFINEON	Page 2 of 2
Product Specification		DESCRIPTION:	EF20/10/06 XFmr
		CUSTOMER P/N :	(NP2019-13911)
		ICT NPR No. :	NP2019-13911
		CUSTOMER Rev.:	ICT Rev.: A
<p>MECHANICAL (UNIT: mm)</p> <p>Marking</p> <div style="border: 1px solid black; padding: 5px; display: inline-block;"> ICT PRC .. NP13911 </div> <p>..Date code(week/year)</p> <p>PIN VIEW</p> <p>pin hole gauge drawing</p> <p>ELECTRICAL SPECIFICATION @25°C</p> <p> TURNS RATIO : W1:W2=130.5Ts:130.5Ts $L_1(1-6)(3-4)$: 39mH+50%/-30% @10kHz, 50mV $L_2(1-6)$: 0.5~1.1mH @10kHz, 50mV, shorted W2 $DCR(1-6)(3-4)$: 2.1Ω Max. HI-POT : 1500Vrms(W1 to W2) @50Hz, for 2Sec. </p> <p>MATERIALS:</p> <p> Bobbin : EF20, Vertical, 4Sec, 4Pins, PET(FR530) or A3X2G7 or equal CORE : EF20/10/6, TS5 or KL5 or R5K or HS502 or equal WIRE : (W1,W2) $\Phi 0.25$mm, UEW , 155°C GLUE : F121A/B or F330A/B or LO-200A/B </p> <p>SCHEMATICS</p>			
Rev.	Change history		
A			

52 W low-cost two-stage LED driver based on ICL5102

A PFC + open-loop LCC design with tight LED current spread

Magnetic component datasheets

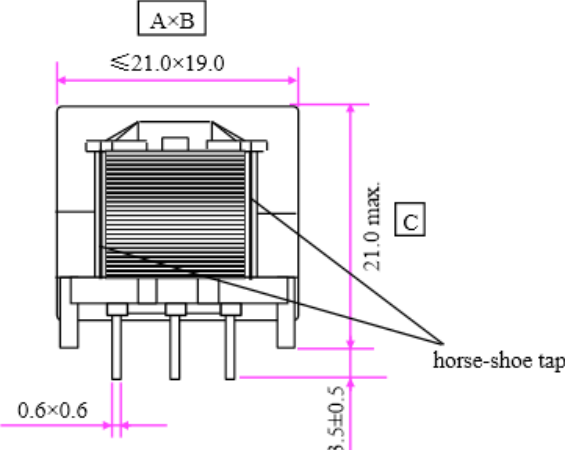
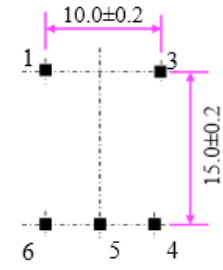
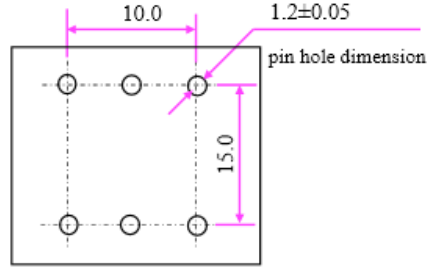
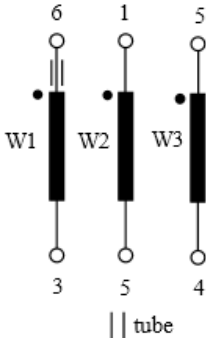

Boost inductor (L7):

 珠海科德电子有限公司 INTELLIGENT COMPONENTS TECHNOLOGY ZHUHAI LTD. (CHINA)	CUSTOMER :	INFINEON	Page 2 of 2
	DESCRIPTION :	EF20/09/11 X'Fmr	
	CUSTOMER P/N :	(NP2019-13912)	CUSTOMER Rev.:
Product Specification	ICT NPR No. :	NP2019-13912	ICT Rev.: A
MECHANICAL (UNIT: mm)			
		Marking ICT PRC .. NP13912 .. Date code	
			
ELECTRICAL SPECIFICATION @25°C		SCHEMATICS	
TURNS RATIO : W1:W2:W3=121.5Ts:18.5Ts:5Ts L(6-3) : 1.8mH±5% @10kHz, 50mV HI-POT : 1500Vrms(Wdgs to Core) @50Hz, for 1Sec. : 500Vrms(W1 to W2,W3) @50Hz, for 1Sec.			
MATERIALS:			
BOBBIN : EF20/11, Vertical, 1 Section, 5 Pins, FR530 or A3X2G7 or equal CORE : EF20/9/11, TP4A or HC44 or PG242 or KP44 or DMR44, Gap≈2×0.40mm WIRE : (W1)10×Φ0.10mm, UEW, 155°C : (W2,W3)Φ0.23mm or Φ0.224mm, UEW +NY,155°C TAPE : 11.4mm wide, CT280 or #1350F or equal TUBE : Teflon tube, AWG#26 GLUE : F121A/B or F330A/B or LO-200A/B or equal : SP2316			
Rev.	Change history		
A			

52 W low-cost two-stage LED driver based on ICL5102

A PFC + open-loop LCC design with tight LED current spread

Magnetic component datasheets



LCC transformer (T300A):

珠海科德电子有限公司 INTELLIGENT COMPONENTS TECHNOLOGY ZHUHAI LTD. (CHINA)	CUSTOMER : INFINEON	Page 2 of 2
	DESCRIPTION: EF25/13/11 X'Fmr	
	CUSTOMER P/N : (NP2019-13822)	CUSTOMER Rev.:
Product Specification	ICT NPR No. : NP2019-13822	ICT Rev.: A3
MECHANICAL (UNIT: mm)		
ELECTRICAL SPECIFICATION @25°C		
TURNS RATIO : W1:W3:W4:W2=84Ts:24Ts:24Ts:12Ts L(2-1) : 13.5~29.0mH @100KHz,50mV L _{L1} (2-1) : 433uH±10% @100KHz,50mV,shorted W3 L _{L2} (2-1) : 433uH±10% @100KHz,50mV,shorted W4 HI-POT : 4500Vrms(W1,W2 to W3,W4) @50Hz, for 2Sec. : 1000Vrms(Wdgs to Core) @50Hz, for 2Sec.		
MATERIALS:		
COVER : EF25/13/11, A3X2G7 or FR530 or equal BOBBIN : EF25/13/11, Horizontal, 2sections, A3X2G7 or FR530 or equal CORE : EF25/13/11, TP4A or DMR44 or KP44 or HC44 or PG242 or equal WIRE : (W1)25×Φ0.071mm, UEW, 155°C : (W3,W4)40×Φ0.071mm, UEW, 155°C, : (W2)Φ0.20mm, Triple insulation wire, TEX-E or TIW-M or TRW-B or TIW-B or E&B-XXXB-1 or equal TAPE : 7.0mm wide, *1350F or CT280 or equal TUBE : Teflon tube, AWG#24 & AWG#22 GLUE : F305A/B or F121A/B or equal		
SCHEMATICS		
Rev.	Change history	
A3		

52 W low-cost two-stage LED driver based on ICL5102

A PFC + open-loop LCC design with tight LED current spread



Electronics BOM

7 Electronics BOM

The BOM is shown below.

#	Quantity	Designator	Description	Manufacturer	Manufacturer Part Number
1	1	C1	Cap 2.2nF/ 250V/ CAPRR1000W60L900T700H1200B/ /20%	MuRata	DE1E3KX222MA4BN01F
2	1	C2	Cap 100nF/ 25V/ 0603/ X7R/5%	Kemet	C0603C104J3RAC
3	1	C3	Cap 330nF/ 630V/ CAPRR1500W80L1800T800H1400B/ /20%	TDK Corporation	B32922C3334M189
4	1	C10	Cap 220nF/ 305V/ CAPRR1500W80L1800T700H1250B/ /10%	Epcos	B32922C3224K
5	1	C12	Cap 2.2nF/ 630V/ CAPC3216X125N/ X7R/10%	muRata	GRM31BR72J222KW01L
6	1	C200	Cap 330pF/ 630V/ 1206/ C0G/5%	MuRata	GRM31A5C2J331JW01
7	1	C201	Cap 22uF/ 450V/ CAPPRD750W80D1625H2700B-B/ /20%	Nichicon	UVZ2W220MHD
8	1	C300	Cap 1uF/ 25V/ 1206 (3216)/ /10%	TDK	CGA5L2X8R1E105K160AA
9	1	C302	Cap 10uF/ 63V/ CAPPRD200W50D500H1200B/ /20%	Panasonic	ECA1JHG100
10	1	C303	Cap 180pF/ 630V/ 1206/ C0G/5%	MuRata	GRM31A5C2J181JW01
11	1	C304	Cap 100nF/ 50V/ 0805/ X7R/10%	TDK	C2012X7R1H104K085AA
12	1	C307	Cap 47nF/ 1kV/ CAPRR1500W80L1800T700H1250B/ /10%	TDK	B32672L0473K000
13	1	C308	Cap 470nF/ 50V/ 603/ X7R/10%	TDK Corporation	CGA3E3X7R1H474K080AB
14	3	C309, C316, C318	Cap 1nF/ 25V/ 0603/ C0G/5%	MuRata	GRM1885C1E102JA01
15	1	C311	Cap 3.3nF/ 50V/ 0603/ C0G/5%	MuRata	GCM1885C1H332JA16
16	1	C312	Cap 100pF/ 50V/ 0805 (2012)/ C0G/5%	Würth Elektronik	885012007057
17	1	C317	Cap 33nF/ 25V/ 0603/ X7R/5%	MuRata	GRM188R71E333JA01
18	1	C319	Cap 100pF/ 50V/ 0603/ C0G/2%	MuRata	GRM1885C1H101GA01
19	1	C400	Cap 1.5nF/ 1.6kV/ CAPRR1000W60L1300T500H1100B/ /5%	TDK Corporation	B32671L1152J000
20	1	C401	Cap 330uF/ 100V/ CAPPRD750W80D1850H2150B/ /20%	Nippon Chemi-Con	EKZE101ELL331MM20S
21	1	C500	Cap 1uF/ 25V/ 0805/ X7R/10%	MuRata	GRM219R71E105KA88
22	1	CY100	Cap 2.2nF/ X1 / Y1, 760 V, 500 V/ Disc/ /20%	Vishay	VY1222M47Y5UQ63V0
23	2	D10, D11	Dio S1PM/ 1kV/ 1A/ DO-220AA (SMP)/ /	Vishay	S1PM-M3/84A
24	4	D17, D21, D22, D23	Dio S1M/ 1kV/ 1A/ DO-214AC (SMA)/ /	ON Semiconductor	S1M
25	2	D200, D201	Dio ES1J/ na, 600V/ 1A/ SMA (DO-214AC)/ /	ON Semiconductor	ES1J
26	4	D300, D301, D303, D305	Dio 1N4148W/ 100V/ 300mA/ SOD123/ /	Diodes Incorporated	1N4148W-7-F
27	2	D400, D401	Dio TSP10H200S/ 200V/ 10A/ TO-277A (SMPC)/ /	Taiwan Semi	TSP10H200S S1G
28	1	DZ302	Dio 18V/ / SOD-123/ /	Vishay	BZT52C18-HE3-08
29	1	F1	Fus 3.15A/ 300V/ FUSRR508W60L850T400H800B/ /	Littelfuse	36913150000
30	2	L1, L2	Ind Ferrite Bead/ 7A/ THT/ /	MuRata	BL02RN2R1M2B
31	1	L7	Ind 10082865F/ / EF20-11/ /	ICT	NP13912
32	1	L10	Ind 39mH/ / F20-10 -6/ /	ICT	NP13911
33	1	L400	Ind 25uH/ / SMT/ /	Cooper Bussmann	CMS1-5-R
34	3	Q200, Q201, Q202	Tra IPN60R600P7S/ 650V/ PG-SOT223-3/ /	Infineon	IPN60R600P7SATMA1

52 W low-cost two-stage LED driver based on ICL5102

A PFC + open-loop LCC design with tight LED current spread

Electronics BOM



35	1	R2	Res 550Vac/ 745V/ Radial/ /	TDK Corporation	B72210S2551K101
36	3	R12, R13, R14	Res 2.2MEG/ 200V/ 1206/ /1%	WELWYN	WCR1206-2M2FI
37	2	R92, R93	Res 33k/ 150V/ 0805/ /1%	Vishay	CRCW080533K0FK
38	3	R104, R105, R106	Res 200k/ 200V/ 1206/ /1%	Vishay	CRCW1206200KFK
39	2	R200, R201	Res 33R/ 200V/ 1206/ /5%	Yageo	AC1206JR-0733RL
40	3	R202, R205, R208	Res 1.2MEG/ 200V/ 1206/ /1%	Vishay	CRCW12061M20FK
41	1	R203	Res 22R/ 150V/ 0805/ /1%	Vishay	CRCW080522R0FK
42	1	R204	Res 220k/ 150V/ 0805/ /1%	Vishay	CRCW0805220KFK
43	2	R209, R323	Res 0R/ 150V/ 0805/ /0R	Vishay	CRCW08050000Z0
44	3	R210, R211, R212	Res 2.2R/ 150V/ 0805/ /1%	Vishay	CRCW08052R20FK
45	1	R300	Res 1R/ 200V/ 1206/ /1%	Yageo	RC1206FR-071RL
46	1	R301	Res 10R/ 200V/ 1206/ /1%	Vishay	CRCW120610R0FK
47	2	R302, R304	Res 47R/ 150V/ 0805/ /1%	Vishay	CRCW080547R0FK
48	2	R303, R307	Res 51k/ 75V/ 0603/ /1%	Vishay	CRCW060351K0FK
49	1	R305	Res 51k/ 150V/ 0805/ /1%	Vishay	CRCW080551K0FK
50	1	R306	Res 510R/ 150V/ 0805/ /1%	Vishay	CRCW0805510RFK
51	1	R308	Res 470R/ 75V/ 0603/ /1%	Vishay	CRCW0603470RFK
52	3	R310, R311, R312	Res 1R/ 150V/ 0805/ /1%	Vishay	CRCW08051R00FK
53	1	R313	Res 39k/ 75V/ 0603/ /1%	Vishay	CRCW060339K0FK
54	1	R315	Res 0R/ 200V/ 1206/ /	Panasonic	ERJ8GEY0R00V
55	1	R316	Res 22k/ 75V/ 0603/ /1%	Vishay	CRCW060322K0FK
56	2	R317, R339	Res 100k/ / 0603/ /1%	Panasonic	ERT-J1VS104FA
57	1	R320	Res 1k/ 150V/ 0805/ /1%	Vishay	CRCW08051K00FK
58	2	R324, R337	Res 11k/ 75V/ 0603/ /1%	Vishay	CRCW060311K0FK
59	1	R325	Res 4.3k/ 75V/ 0603/ /1%	Vishay	CRCW06034K30FK
60	1	R326	Res 200k/ 75V/ 0603/ /1%	Vishay	CRCW0603200KFK
61	1	R333	Res 510k/ 75V/ 0603/ /1%	Vishay	CRCW0603510KFK
62	2	R334, R336	Res 0R/ 75V/ 0603/ /1%	Vishay	CRCW06030000Z0
63	1	R335	Res 6.2k/ 75V/ 0603/ /1%	Vishay	CRCW06036K20FK
64	1	R401	Res 100k/ 200V/ 1206/ /1%	Vishay	CRCW1206100KFK
65	2	R402, R403	Res 100k/ 150V/ 0805/ /1%	Vishay	TNPW0805100KBEEN
66	1	S1	Switch 2Pos/ / DIP-4/ /	Greyhill	78B02ST
67	1	T300	Tra NP13822/ / THT/ /	ICT	NP13822
68	1	U300	IC ICL5102/ / PG-DSO-16/ /	Infineon	ICL5102
69	1	X10	Con 1888690/ / CON-TER-THT-MKDSN 2,5_3-5,08/ /	Phoenix Contact	1888690
70	1	X101	Con 1729128/ / CON-TER-THT-MKDSN 1,5_2-5,08/ /	Phoenix Contact	1729128
71	0	R10, R11	Res NA/ 500V/ 2512/ /0R	Vishay	CRCW25120000Z0
72	0	R206	Res NA/ 75V/ 0603/ /1%	Yageo	RC0603FR-0710KL
73	0	R309, R338	Res NA/ 75V/ 0603/ /1%	Vishay	CRCW060310K0FK, CRCW0603510KFK
74	0	R319	Res NA/ 150V/ 0805/ /1%	Vishay	CRCW080510K0FK
75	0	X1, X301	Con JL-1000-25-T/ / JP-THT-JL-1000-25-T/ /	Samtec	JL-1000-25-T
76	0	X2, X3	Con JP-THT-L-17.5mm/ / JP-THT-1.00_2.20_17.5_0.80-2P/ /	Manufacturer	JP-THT-1.00_2.20_17.5_0.80-2P
77	0	X11, X12	Con JL-250-25-T/ / JP-THT-JL-250-25-T/ /	Samtec	JL-250-25-T

Revision history

Document version	Date of release	Description of changes
V1.0	17-03-2020	

Trademarks

All referenced product or service names and trademarks are the property of their respective owners.

Edition 2020-07-13

Published by

Infineon Technologies AG

81726 Munich, Germany

© 2020 Infineon Technologies AG.

All Rights Reserved.

Do you have a question about this document?

Email: erratum@infineon.com

Document reference

ER_2005_PL21_2006_154743

IMPORTANT NOTICE

The information given in this document shall in no event be regarded as a guarantee of conditions or characteristics ("Beschaffheitsgarantie").

With respect to any examples, hints or any typical values stated herein and/or any information regarding the application of the product, Infineon Technologies hereby disclaims any and all warranties and liabilities of any kind, including without limitation warranties of non-infringement of intellectual property rights of any third party.

In addition, any information given in this document is subject to customer's compliance with its obligations stated in this document and any applicable legal requirements, norms and standards concerning customer's products and any use of the product of Infineon Technologies in customer's applications.

The data contained in this document is exclusively intended for technically trained staff. It is the responsibility of customer's technical departments to evaluate the suitability of the product for the intended application and the completeness of the product information given in this document with respect to such application.

For further information on the product, technology delivery terms and conditions and prices please contact your nearest Infineon Technologies office (www.infineon.com).

WARNINGS

Due to technical requirements products may contain dangerous substances. For information on the types in question please contact your nearest Infineon Technologies office.

Except as otherwise explicitly approved by Infineon Technologies in a written document signed by authorized representatives of Infineon Technologies, Infineon Technologies' products may not be used in any applications where a failure of the product or any consequences of the use thereof reasonably be expected to result in personal injury.

Looking for pricing, stock, or lifecycle information?

Click below to explore more details on WIN SOURCE:

- ⊖ [View REFICL5102U52WCCTOBO1 on WIN SOURCE](#)
- ⊖ [Infineon Technologies Information](#)

Optimize Your Supply Chain with WIN SOURCE Solutions

- ✓ Global Sourcing Solution
- ✓ Obsolete Management
- ✓ Cost Control Management
- ✓ Shortage Management
- ✓ Alternative Solution
- ✓ Excess Inventory Management