

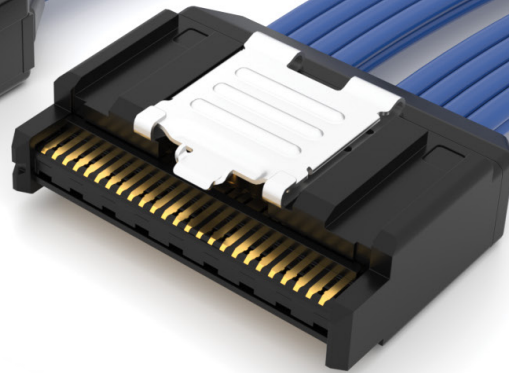

# ACCELERATE<sup>®</sup>

## SLIM, DIRECT ATTACH CABLE ASSEMBLIES

(0.635 mm) .025" PITCH

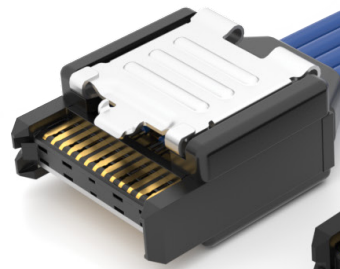
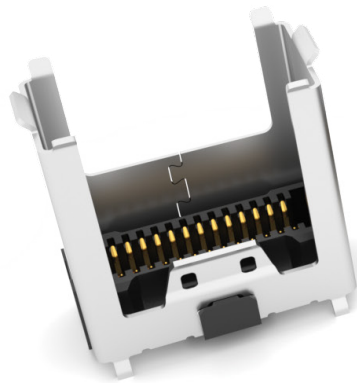

PAM 4

64  
G b p s

### FEATURES & BENEFITS

- Slimmest cable assembly in the industry - 7.6 mm width
- High-density 2-row design
- 8, 16 and 24 differential pair configurations
- 34 AWG, 100 Ω Eye Speed<sup>®</sup> ultra low skew twinax cable
- Multiple wiring options including reverse polarity
- Mating board level socket (ARF6 Series) features standard rugged weld tabs for increased stability on the PCB
- Rugged metal latching and shielding
- Supports 64 Gbps PAM4 (32 Gbps NRZ) applications
- PCIe<sup>®</sup> 6.0/CXL<sup>™</sup> 3.1 capable
- Utilizes Samtec's Flyover<sup>®</sup> Technology to simplify board layout and extend signal reach

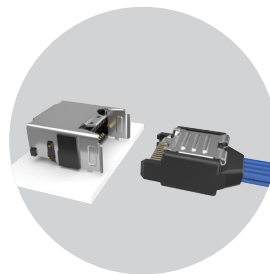

Right-angle available.  
Visit [samtec.com?ARF6-RA](https://www.samtec.com?ARF6-RA)  
for specifications.

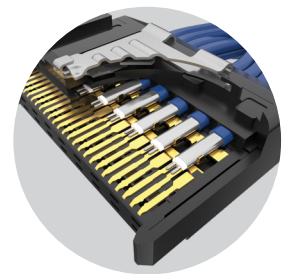

Contacts directly  
soldered to the twinax for  
improved signal integrity

### KEY SPECIFICATIONS (ARC6/ARF6)

PITCH	CABLE	SIGNAL ROUTING	INSULATOR MATERIAL	CONTACT MATERIAL	PLATING	OPERATING TEMP RANGE
(0.635 mm) .025"	34 AWG Eye Speed <sup>®</sup> ultra low skew twinax	100 Ω Differential	Black LCP	Copper Alloy	Au over 50 μ" (1.27 μm) Ni	-40 °C to +125 °C

PCI-SIG<sup>®</sup>, PCI Express<sup>®</sup> and the PCIe<sup>®</sup> design marks are registered trademarks and/or service marks of PCI-SIG.

**(0.635 mm) .025" • SLIM CABLE & SOCKET**

ARC6	NO OF PAIRS	CABLE LENGTH	END 1	END 2	WIRING OPTION	CABLE TYPE
------	-------------	--------------	-------	-------	---------------	------------

-08  
-16  
-24

-"XX.X"  
= Length in Inches  
03.0" (76.2 mm)  
minimum

-LU  
= Latch Up

-LU  
= Latch Up  
-LD  
= Latch Down

-2  
= Pin 1 to Pin 2  
(End 2 -LD option only)

-3  
= Pin 1 to Pin N-1  
(End 2 -LU option only)

-2R  
= Pin 1 to Pin 2  
Reversed Polarity  
(End 2 -LD option only)  
06.0" (152.4 mm) min.  
cable length

-3R  
= Pin 1 to Pin N-1  
Reversed Polarity  
(End 2 -LU option only)  
06.0" (152.4 mm) min.  
cable length

-1  
= 34 AWG 100 Ω  
Eye Speed®  
Ultra low skew  
twinax

**ARC6**  
Board Mates:  
ARF6

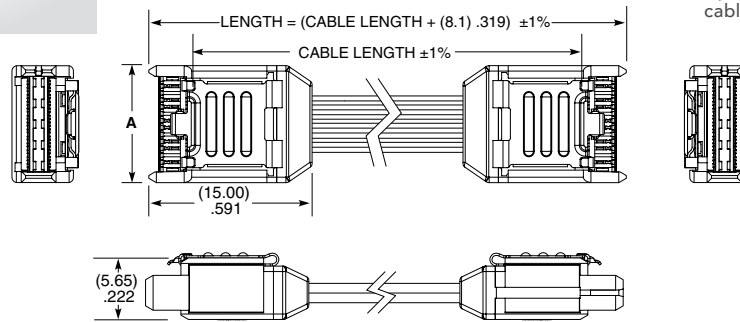

**ARC6-08-XX.X-LU-LU-3-X SHOWN**

NO. OF PAIRS	A	N	N-1
-08	(10.90) .429	26	25
-16	(18.52) .729	50	49
-24	(26.14) 1.029	74	73

**Notes:**  
Cable lengths longer than 40.00" (1 meter) are not supported with S.I. test data.

View complete specifications at: [samtec.com?ARC6](http://samtec.com?ARC6)

ARF6	NO. OF PAIRS	PLATING	ROW	A	K	"X"R
------	--------------	---------	-----	---	---	------

-08  
-16  
-24

-S  
= 30 μ" (0.76 μm)  
Gold on contact area,  
Matte Tin on tail

-D  
= Double  
Row

-A  
= Alignment  
Pin

-K  
= Polyimide  
film Pick &  
Place Pad

-TR  
= Tape & Reel

-FR  
= Full Reel  
Tape & Reel  
(must order  
maximum quantity  
per reel; contact  
Samtec for  
quantity breaks)

**ARF6**  
Cable Mates:  
ARC6

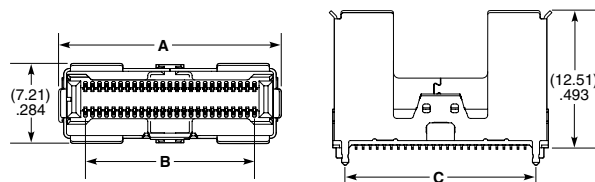
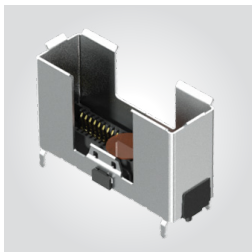

**ARF6-16-S-D-A SHOWN**

NO. OF PAIRS	A	B	C
-08	(12.46) .491	(7.62) .300	(9.59) .378
-16	(20.08) .791	(15.24) .600	(17.21) .678
-24	(27.70) 1.091	(22.86) .900	(24.83) .978



**Notes:**  
Tape & Reel packaging and K-Dot are standard.

Some sizes, styles and options are non-standard, non-returnable.

View complete specifications at: [samtec.com?ARF6](http://samtec.com?ARF6)

## Looking for pricing, stock, or lifecycle information?

Click below to explore more details on WIN SOURCE:

-  [View ARC6-16-21.0-LU-LU-3-1 on WIN SOURCE](#)
-  [Samtec Inc. Information](#)

## Optimize Your Supply Chain with WIN SOURCE Solutions

-  Global Sourcing Solution
-  Obsolete Management
-  Cost Control Management
-  Shortage Management
-  Alternative Solution
-  Excess Inventory Management