



**THE DATASHEET OF
KER340UL Y/R**



Stainless Steel Enclosed Motor Disconnect Switch



- UL Type 4X
- Ideal where chemicals are used for cleaning and maintenance such as food processing and breweries
- Mining is another application area
- Stainless Steel (Grade AISI 316)
- Corrosion Resistant
- IP66 Protection Level
- Lockable - Defeatable Handle



All Models are lockable with up to 3 padlocks.

NEW

Catalog Number

	KER316UL	KER325UL	KER340UL
Black Handle	KER316UL	KER325UL	KER340UL
Yellow/Red Handle	KER316UL Y/R	KER325UL Y/R	KER340UL Y/R
No. of Poles	3 (4 pole - KER416UL (Y/R))	3 (4 pole - KER425UL (Y/R))	3 (4 pole - KER440UL (Y/R))
General Purpose Current	16 A	25 A	40 A
Maximum Voltage	600V AC	600V AC	600V AC
Motor FLA @ 480V AC	14 A	21 A	27 A
Motor FLA @ 600V AC	9 A	11 A	17 A

Horsepower Rating/HP	KER316UL		KER325UL		KER340UL	
	1 Phase	3 Phase	1 Phase	3 Phase	1 Phase	3 Phase
110-120V AC	1	2	1.5	3	2	3
200V AC	1.5	3	2	5	3	7.5
208V AC	1.5	3	2	5	3	7.5
220-240V AC	2	3	3	5	5	7.5
265V AC	-	5	-	7.5	-	10
277V AC	-	5	-	7.5	-	10
380-415V AC	-	7.5	-	10	-	15
440-480V AC	-	10	-	15	-	20
550-600V AC	-	7.5	-	10	-	15

Short Circuit Withstand Rating at 600 V with Max. Fuse Size/Class:	KER316UL	KER325UL	KER340UL
	10 kA	10 kA	10 kA
K5	30 A	30 A	30 A
RK5	30 A	30 A	30 A
RK1	60 A	60 A	60 A
J	80 A	80 A	80 A

Terminal Size Acceptability	KER316UL	KER325UL	KER340UL
(Cu Conductors only, 75 °C)	14-8 AWG	14-8 AWG	14-8 AWG
Terminal Torque	16 lb. in. (1.8 Nm)	16 lb. in. (1.8 Nm)	16 lb. in. (1.8 Nm)
Screw Head Type	No. 2 Pozidrive	No. 2 Pozidrive	No. 2 Pozidrive
Environmental Rating	UL Type 4X	UL Type 4X	UL Type 4X
Enclosure Type Used	H23	H23	H23

Dimensions

(to convert to inches multiply by 0.03937)

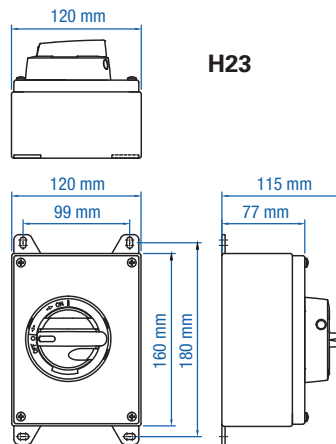

Enclosure Cover Screw Installation (Additional Information)

Enclosure	Screw Type	Torque
H23	Pz2	17.7 lb. in. (2 Nm)
H32	Pz2	17.7 lb. in. (2 Nm)



Weight	KER316UL	KER325UL	KER340UL
	1.35 kg (2.98 lb.)	1.35 kg (2.98 lb.)	1.35 kg (2.98 lb.)

Suitable Accessories







Auxiliary Contacts	KER316UL	KER325UL	KER340UL
	KU1.V, KU2.V	KU1.V, KU2.V	KU1.V, KU2.V

Looking for pricing, stock, or lifecycle information?

Click below to explore more details on WIN SOURCE:

-  [View KER340UL Y/R on WIN SOURCE](#)
-  [Altech corporation](#) Information

Optimize Your Supply Chain with WIN SOURCE Solutions

-  Global Sourcing Solution
-  Obsolete Management
-  Cost Control Management
-  Shortage Management
-  Alternative Solution
-  Excess Inventory Management