



**THE DATASHEET OF  
ACML-0201-241-T**



# SMT Multilayer Chip Bead



ACML-0201 Series

Request Samples



Check Inventory



0.6 x 0.3 x 0.3 mm  
RoHS/RoHS II Compliant  
MSL Level = 1

## Features

- Internal silver printed layers and magnetically shielded to minimize crosstalk.
- Substantial EMI suppression over a wide frequency range.
- Excellent solderability and heat resistance

## Applications

- Noise suppression for computers and peripheral devices, DVD cameras, LCD TVs, communication equipment, OA equipment, etc.
- Reduces noise in ultra-high speed signaling circuits as well.

## Electrical Specifications

Part Number	Impedance	Tolerance	DC Resistance	Rated Current
	100MHz/50mV		Max	Max
Units	$\Omega$	%	m $\Omega$	mA
Symbol	Z		DCR	Ir
ACML-0201-600	0.13	$\pm 25$	0.40	200
ACML-0201-800	0.27	$\pm 25$	0.60	200
ACML-0201-121	0.30	$\pm 25$	0.80	200
ACML-0201-241	0.40	$\pm 25$	1.00	200
ACML-0201-471	0.47	$\pm 25$	1.40	200
ACML-0201-601	0.62	$\pm 25$	1.70	200

### Test Conditions and equipments

**Z:** High Accuracy RF Impedance/Material Analyzer -E4991A, 100MHz, -20dBm or 50mV

**DCR:** High Accuracy Milliohmmeter –HP4338B

**Ir:** Electric Power Supply, Electric Current Meter, Thermometer.  $\Delta T \leq 20^\circ\text{C}$

Unless otherwise specified, the standard atmospheric conditions for measurement/test as:

- a. Ambient Temperature:  $20 \pm 15^\circ\text{C}$
- b. Relative Humidity:  $65\% \pm 20\%$
- c. Air Pressure: 86 KPa to 106 KPa

### Visual Examination

- a. Inspection Equipment: Microscope, 20X magnification

ACML-0201 Series is RoHS Compliant and Pb free

Operating Temperature:  $-55^\circ\text{C} \sim +125^\circ\text{C}$

Storage Temperature (on PCB):  $-55^\circ\text{C} \sim +125^\circ\text{C}$

Storage Temperature (in original packaging):  $-10^\circ\text{C} \sim +40^\circ\text{C}$ , 70 RH maximum.



5101 Hidden Creek Ln, Spicewood TX 78669  
Phone: 512-371-6159 Fax: 512-351-8858  
For terms and conditions of sales, please visit:  
[www.abracon.com](http://www.abracon.com)

REVISION A : 3/11/2024

ABRACON IS  
ISO9001-2015  
CERTIFIED

# SMT Multilayer Chip Bead



**ACML-0201 Series**

Request Samples



Check Inventory



**0.6 x 0.3 x 0.3 mm**  
**RoHS/RoHS II Compliant**  
**MSL Level = 1**

## Part Identification

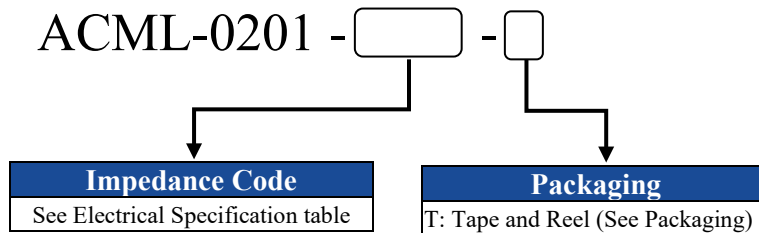

## Mechanical Specifications

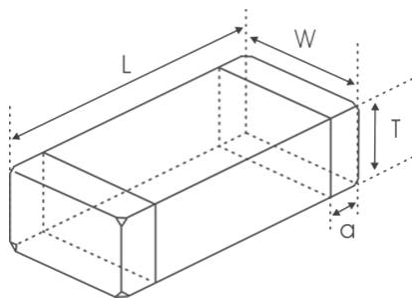

Series	L	W	T	a
ACML-0201	0.6±0.05 [0.024±0.002]	0.3±0.05 [0.012±0.002]	0.3±0.05 [0.012±0.002]	0.15±0.05 [0.006±0.002]

Dimensions: mm[inches]

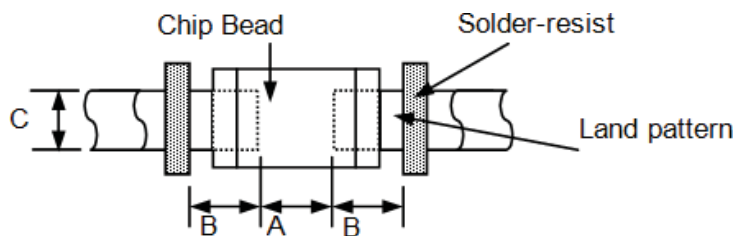

A	B	C
0.2~0.3	0.2~0.3	0.3~0.35

Dimensions: mm

# SMT Multilayer Chip Bead



ACML-0201 Series

Request Samples



Check Inventory



0.6 x 0.3 x 0.3 mm  
RoHS/RoHS II Compliant  
MSL Level = 1

## Performance Graphs

ACML-0201-600

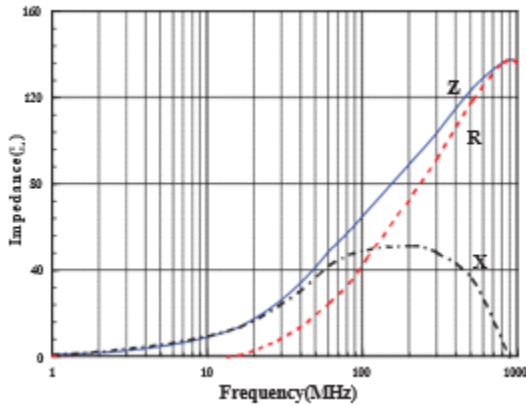

ACML-0201-800

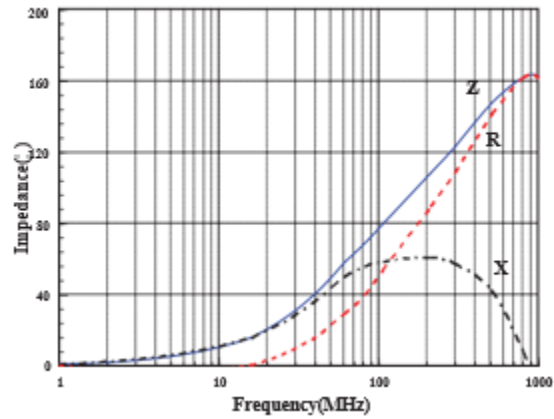

ACML-0201-121

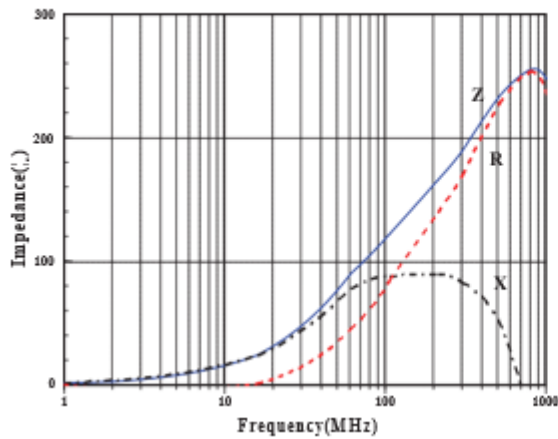

ACML-0201-241

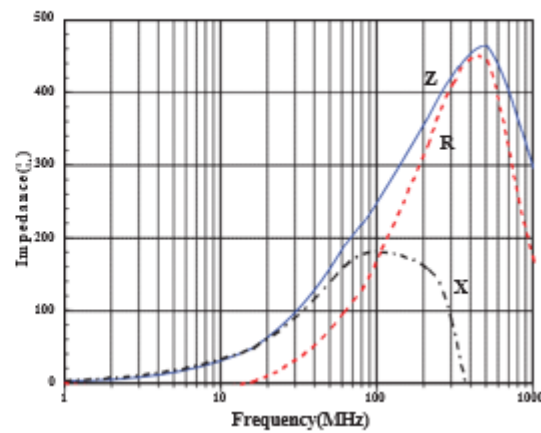

ACML-0201-471

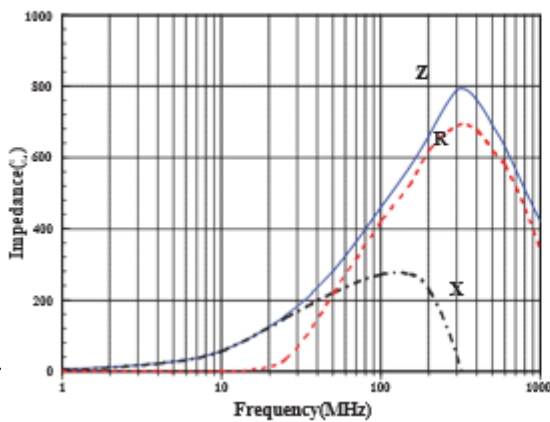

ACML-0201-601

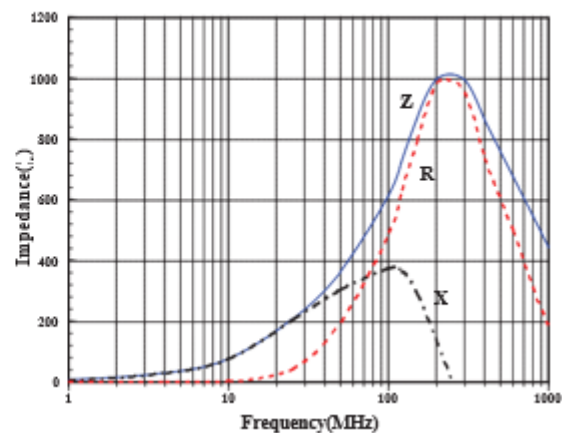

Phone: 512-571-0159 FAX: 512-551-8858  
For terms and conditions of sales, please visit:  
[www.abracon.com](http://www.abracon.com)

REVISION A : 3/11/2024

ABRACON IS  
ISO9001-2015  
CERTIFIED

# SMT Multilayer Chip Bead



ACML-0201 Series

Request Samples



Check Inventory



0.6 x 0.3 x 0.3 mm  
RoHS/RoHS II Compliant  
MSL Level = 1

## Materials

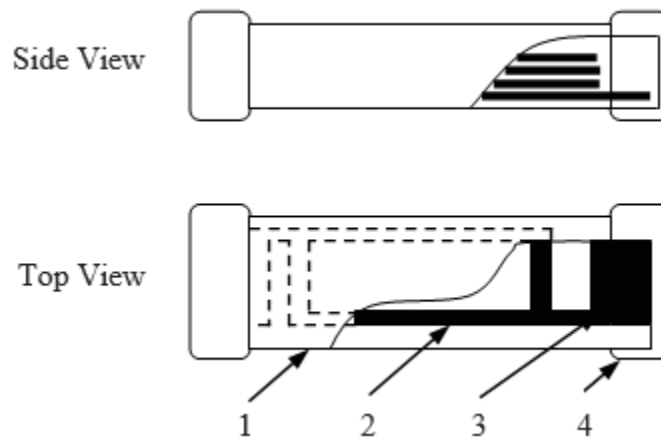

	Component	Material
1	Base Material	Ferrite
2	Internal Conductor	Ag
3	Pull out Electrode	Ag
4	Terminal Electrode	Ag (Inner layer) Ni-Sn (Outer layer)

# SMT Multilayer Chip Bead



ACML-0201 Series

Request Samples



Check Inventory



0.6 x 0.3 x 0.3 mm  
RoHS/RoHS II Compliant  
MSL Level = 1

## Reflow Profile

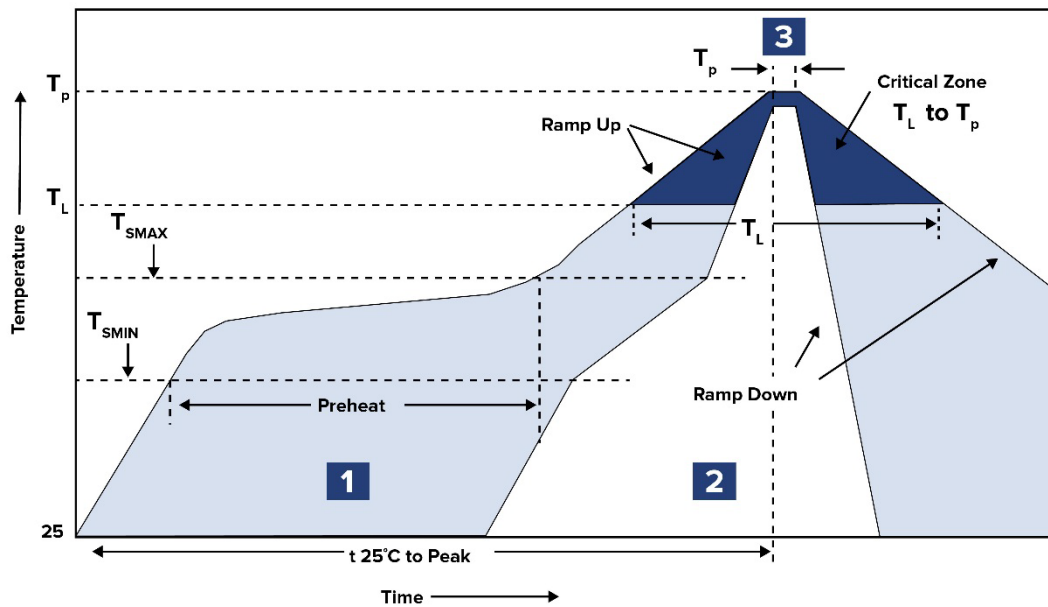

Zone	Description	Temperature	Times
1	Preheat	$T_{SMIN} \sim T_{SMAX}$ 150°C ~ 200°C	60 ~ 120 sec.
2	Reflow	$T_L$ 217°C	60 ~ 90 sec.
3	Peak heat	$T_P$ 260°C±5°C	10 sec. MAX

# SMT Multilayer Chip Bead



ACML-0201 Series

Request Samples



Check Inventory



0.6 x 0.3 x 0.3 mm  
RoHS/RoHS II Compliant  
MSL Level = 1

## Packaging

Tape & Reel: 15K pcs/reel

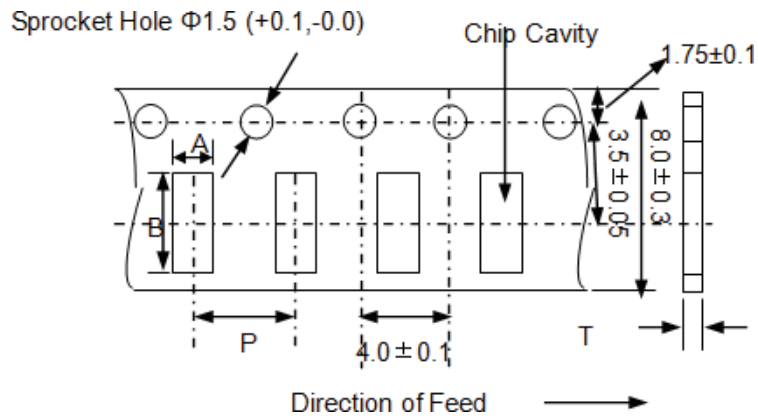

A	B	P	t(max)
0.40±0.1	0.70±0.1	2.0±0.1	0.55

Dimensions: mm

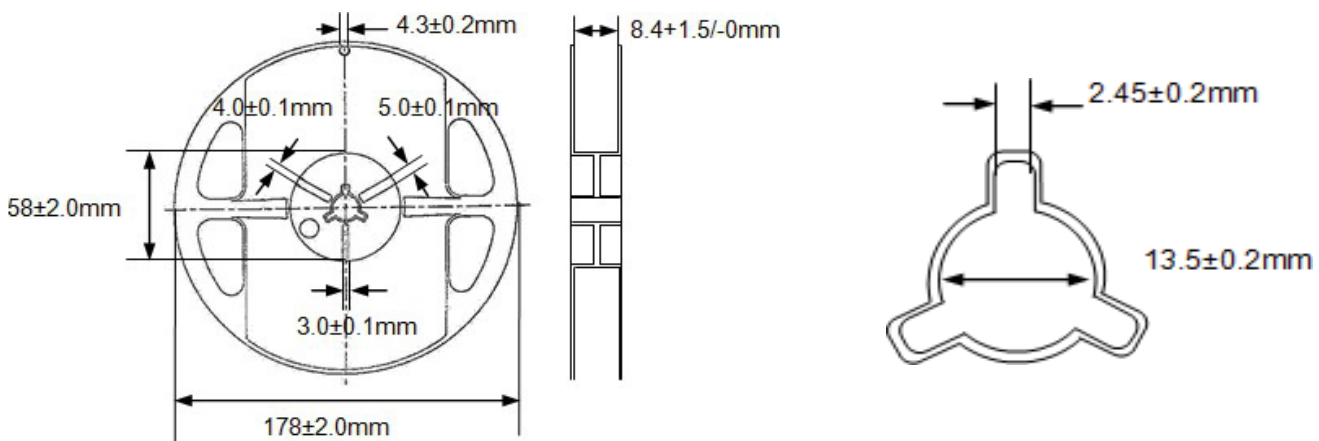

**ATTENTION:** Abracon LLC's products are Commercial-Off-The-Shelf (COTS), which are designed, intended and validated for use in commercial, industrial and automotive applications. The customer is responsible for testing and verifying the performance of an Abracon solution to meet their system-level requirements.





Phone: 512-571-6159 Fax: 512-551-8858  
For terms and conditions of sales, please visit:  
[www.abracon.com](http://www.abracon.com)

REVISION A : 3/11/2024

ISO9001-2015  
CERTIFIED

## Looking for pricing, stock, or lifecycle information?

Click below to explore more details on WIN SOURCE:

-  [View ACML-0201-241-T on WIN SOURCE](#)
-  [Abracon LLC Information](#)

## Optimize Your Supply Chain with WIN SOURCE Solutions

-  Global Sourcing Solution
-  Obsolete Management
-  Cost Control Management
-  Shortage Management
-  Alternative Solution
-  Excess Inventory Management