



**THE DATASHEET OF  
M5233FP#DF1J**



MITSUBISHI <LINEAR ICs>  
**M5233L, P, FP**

**DUAL COMPARATOR**

**DESCRIPTION**

The M5233 is a semiconductor circuit for a comparator designed to operate over a wide supply voltage range from 2 to 36V from a single power supply, with two circuits in each 8-pin SIP and 8-pin DIP and 8-pin mini flat package. A differential circuit which is equivalent to a conventional single power supply operational amplifier is used to enable operation from GND level to improve input characteristics. Power dissipation (circuit current) is low and output voltage is large. It fits to a general-purpose comparator for a variety of electronic equipment.

**FEATURES**

- Wide operating supply voltage range ..... 2V~36V  
 Dual power supplies:  $\pm 1V \sim \pm 18V$
- Low circuit current ..... 0.6mA (typ.)
- Wide common mode input voltage range  
 .....  $0V \sim V_{CC} - 1.5V$  (single power supply)
- Open collector output
- Output sink current ..... 25mA
- Response time .....  $1.3\mu\text{sec}$
- Pin compatible with general-purpose comparators 393, 2930

**APPLICATION**

Voltage comparator, window comparator, CR timer, time delay circuit, oscillator, etc.

**RECOMMENDED OPERATING CONDITIONS**

- Supply voltage range ..... 2~36V
- Rated supply voltage ..... 12V

**PIN CONFIGURATION (TOP VIEW)**

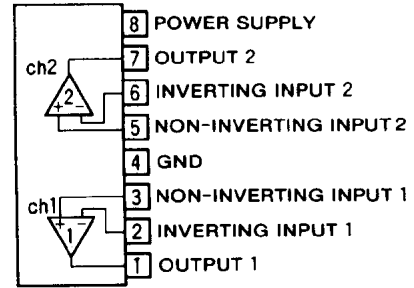

Outline 8P5 (L)

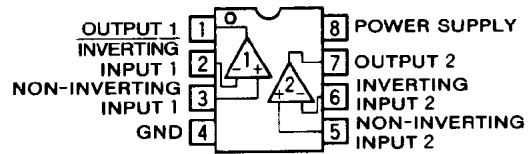

Outline 8P4 (P)

8P2S-A (FP)

**EQUIVALENT CIRCUIT**

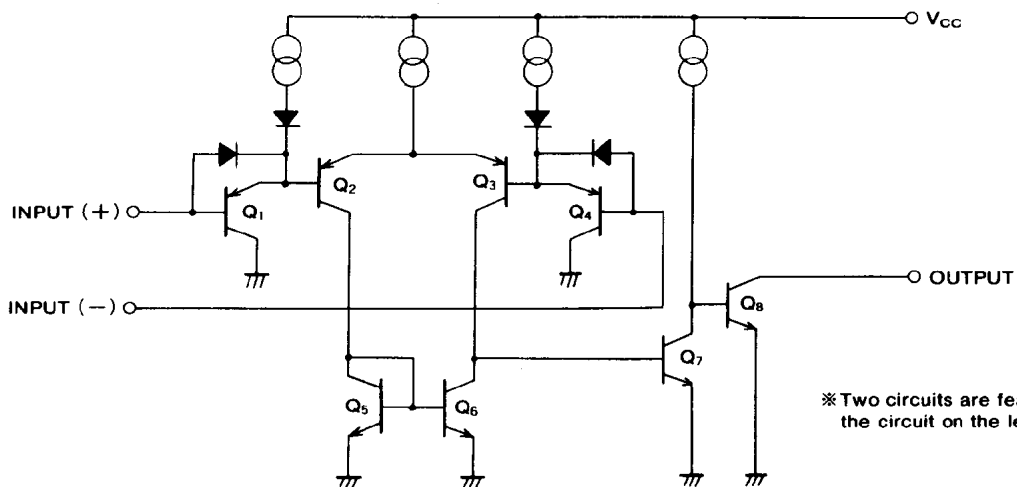

※ Two circuits are featured in the circuit on the left.

**DUAL COMPARATOR**

**ABSOLUTE MAXIMUM RATINGS** ( $T_a=25^\circ\text{C}$ , unless otherwise noted)

Symbol	Parameter	Ratings	Unit
$V_{CC}$	Supply voltage	36( $\pm 18$ )	V
$V_{ID}$	Differential input voltage	36	V
$V_{ICM}$	Common mode input voltage range	-0.3~+36	V
$P_d$	Power dissipation	800(SIP)/625(DIP)/440(FP)	mW
$T_{opr}$	Operating temperature	-20~+75	$^\circ\text{C}$
$T_{stg}$	Storage temperature	-55~+125	$^\circ\text{C}$

**ELECTRICAL CHARACTERISTICS** ( $T_a=25^\circ\text{C}$ ,  $V_{CC}=5\text{V}$ )

Symbol	Parameter	Test conditions	Limits			Unit
			Min	Typ	Max	
$V_{IO}$	Input offset voltage	$V_O=1.4\text{V}$ , $V_{REF}=1.4\text{V}$ , $R_S=0\Omega$		2	5	mV
$I_{IO}$	Input offset current			5	50	nA
$I_B$	Input bias current			25	250	nA
$V_{ICM}$	Common mode input voltage range		0		$V_{CC}-1.5$	V
$G_V$	Voltage gain	$R_L=15\text{k}\Omega$		200		V/mV
$I_{CC}$	Circuit current	$R_L=\infty$		0.6	1	mA
$t_{PLH}$	Response time	$R_L=5.1\text{k}\Omega$ , $V_{RL}=5\text{V}$		1.3		$\mu\text{sec}$
$I_{sink}$	Output sink current	$V_{IN(-)}=1\text{V}$ , $V_{IN(+)}=0\text{V}$ , $V_O\leq 1.5\text{V}$	10	25		mA
$V_{OL}$	Output saturation voltage	$V_{IN(-)}=1\text{V}$ , $V_{IN(+)}=0\text{V}$ , $I_{sink}=8\text{mA}$		200	400	mV
$I_{LO}$	Output leak current	$V_{IN(+)}=1\text{V}$ , $V_{IN(-)}=0\text{V}$ , $V_O=5\text{V}$		0.1		nA

**TYPICAL CHARACTERISTICS**

**THERMAL DERATING (MAXIMUM RATING)**

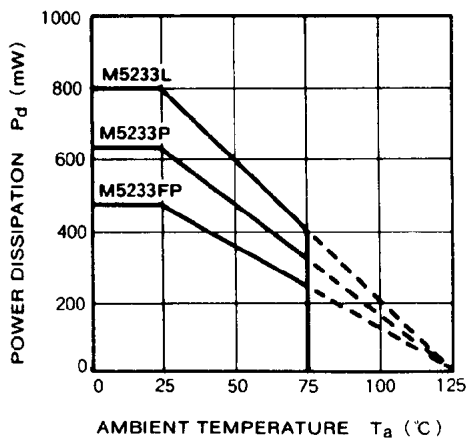

**CIRCUIT CURRENT VS. SUPPLY VOLTAGE**

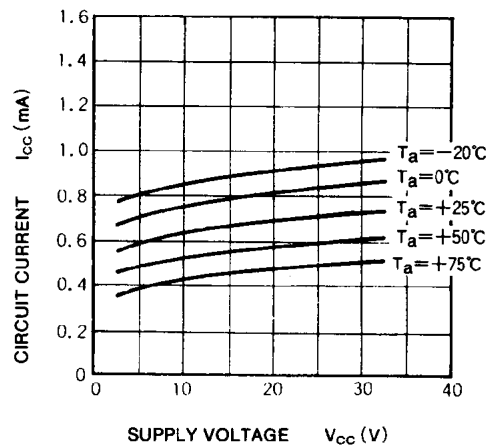

**INPUT BIAS CURRENT VS. SUPPLY VOLTAGE**

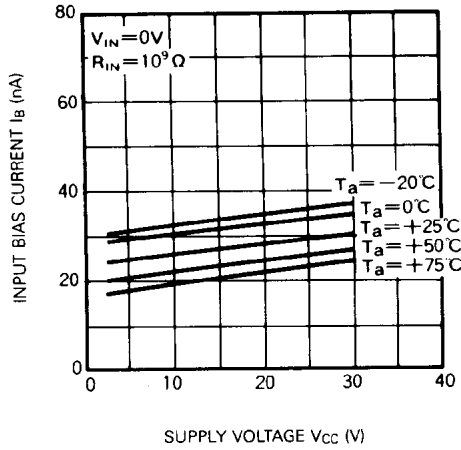

**OUTPUT SATURATION VOLTAGE VS. OUTPUT SINK CURRENT**

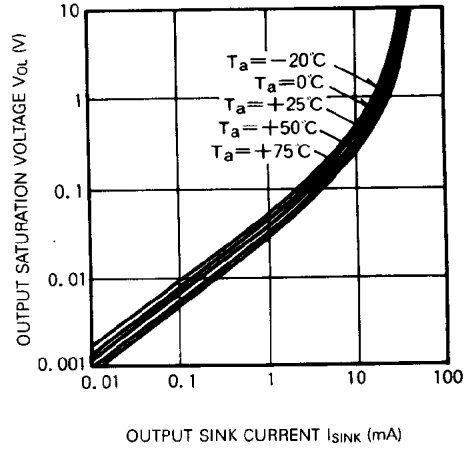

**RESPONSE TIME FOR VARIOUS INPUT OVERDRIVES VS. NEGATIVE TRANSITION**

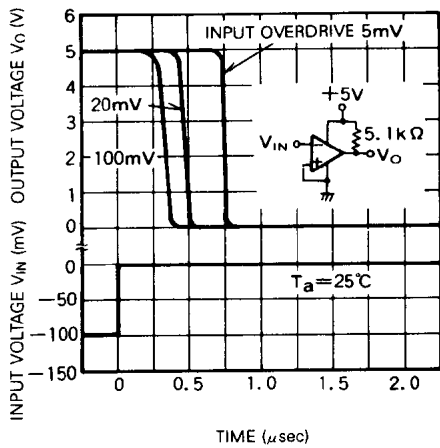

**RESPONSE TIME FOR VARIOUS INPUT OVERDRIVES VS. NEGATIVE TRANSITION**

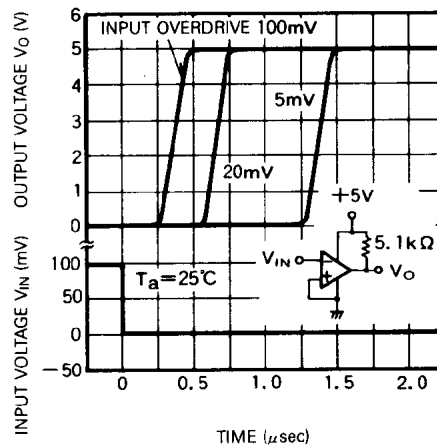

## Looking for pricing, stock, or lifecycle information?

Click below to explore more details on WIN SOURCE:

-  [View M5233FP#DF1J on WIN SOURCE](#)
-  [Renesas Electronics America Information](#)

## Optimize Your Supply Chain with WIN SOURCE Solutions

-  Global Sourcing Solution
-  Obsolete Management
-  Cost Control Management
-  Shortage Management
-  Alternative Solution
-  Excess Inventory Management