



**THE DATASHEET OF
AISC-0603HP-7N2J-T**



HIGH CURRENT CERAMIC WIRE WOUND INDUCTORS

AISC-0603HP



RoHS/RoHS II Compliant

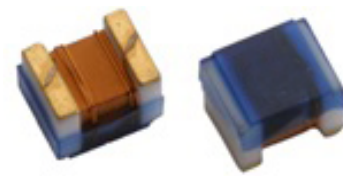

1.80 x 1.12 x 1.02mm

FEATURES:

- Higher Q and lower DCR than other 0603 inductors
- Very high SRF – as high as 8.5 GHz
- Excellent current handling capability – up to 2100mA
- Wide range of Inductance values available for flexible needs
- Tight tolerance of 2% is available.

APPLICATIONS:

- Widely used in communications applications such as cell phones, cable modems, ADSL, repeaters.
- Bluetooth, W-LAN, GPS, Broadband Network
- Video cameras, liquid crystal television, and other electronic devices
- Suitable for RF circuit

ELECTRICAL SPECIFICATIONS:

PARAMETERS

ABRACON P/N:	AISC-0603HP Series
Operating temperature:	-40°C to +125°C
Storage temperature:	-10°C to +40°C, 20% to 70% RH in Tape & Reel

Part Number AISC-0603HP- Inductance Code	Inductance	Tolerance	Min. Quality Factor	L/Q Test Freq.	Typ. Quality Factor @ 250MHz /900MHz	Max. DC Resistance	Max. Rated Current	Min. Self-resonant Frequency
Units	nH	-	-	MHz		Ω	mA	MHz
Symbol	L	-	Q	Freq.		DCR	I _r	S.R.F
AISC-0603HP-1N7	1.7	B, S	24	250	31/50	0.033	2100	8500
AISC-0603HP-2N2	2.2	B, S	13	250	15/27	0.150	900	7000
AISC-0603HP-3N3	3.3	B, S	35	250	37/64	0.035	1700	6900
AISC-0603HP-3N6	3.6	B, S	35	250	42/67	0.035	1700	6900
AISC-0603HP-3N9	3.9	B, S	30	250	39/62	0.039	1600	6900
AISC-0603HP-4N3	4.3	B, S	30	250	40/64	0.045	1500	6000
AISC-0603HP-4N7	4.7	B, S	22	250	29/50	0.090	1100	5800
AISC-0603HP-5N1	5.1	B, J, K	20	250	27/46	0.108	1000	5700
AISC-0603HP-6N2	6.2	B, J, K	35	250	44/68	0.050	1400	5800
AISC-0603HP-6N8	6.8	B, J, K	35	250	50/79	0.050	1400	5800
AISC-0603HP-7N2	7.2	B, J, K	35	250	47/71	0.052	1400	4800
AISC-0603HP-7N5	7.5	B, J, K	35	250	46/74	0.070	1300	4800
AISC-0603HP-8N2	8.2	B, J, K	35	250	45/69	0.054	1400	4300
AISC-0603HP-8N7	8.7	B, J, K	30	250	38/61	0.100	1000	4600
AISC-0603HP-9N1	9.1	J, K	28	250	35/57	0.108	1000	4300
AISC-0603HP-9N5	9.5	J, K	35	250	50/76	0.060	1350	5000
AISC-0603HP-10N	10	G, J, K	35	250	50/82	0.060	1350	4800
AISC-0603HP-11N	11	G, J, K	35	250	54/82	0.060	1350	4200
AISC-0603HP-12N	12	G, J, K	35	250	52/80	0.078	1200	4000
AISC-0603HP-15N	15	G, J, K	38	250	54/83	0.085	1100	4000
AISC-0603HP-16N	16	G, J, K	38	250	53/78	0.085	1100	3300
AISC-0603HP-18N	18	G, J, K	38	250	51/71	0.078	1200	3100
AISC-0603HP-22N	22	G, J, K	40	250	55/75	0.120	950	3000
AISC-0603HP-23N	23	G, J, K	40	250	55/75	0.120	950	2850
AISC-0603HP-24N	24	G, J, K	40	250	50/66	0.080	1100	2650
AISC-0603HP-27N	27	J, K	40	250	53/68	0.125	950	2800
AISC-0603HP-30N	30	G, J, K	40	250	55/66	0.130	920	2400
AISC-0603HP-33N	33	G, J, K	40	250	51/55	0.170	680	2300
AISC-0603HP-36N	36	G, J, K	40	250	55/63	0.150	750	2300
AISC-0603HP-39N	39	G, J, K	40	250	55/58	0.180	680	2200
AISC-0603HP-43N	43	G, J, K	40	250	52/53	0.170	810	2100
AISC-0603HP-47N	47	G, J, K	38	200	51/50	0.200	680	2000
AISC-0603HP-51N	51	G, J, K	38	200	50/46	0.250	660	1900
AISC-0603HP-56N	56	G, J, K	38	200	53/46	0.230	700	1900
AISC-0603HP-68N	68	G, J, K	38	200	50/39	0.280	650	1700
AISC-0603HP-72N	72	G, J, K	34	150	50/38	0.350	580	1700

ABRACON IS
ISO 9001:2008
CERTIFIED



ABRACON
CORPORATION

Visit www.abracon.com for Terms & Conditions of Sale

30332 Esperanza, Rancho Santa Margarita, California 92688
tel 949-546-8000 fax 949-546-8001 www.abracon.com

Revised: 04.06.13

HIGH CURRENT CERAMIC WIRE WOUND INDUCTORS

AISC-0603HP



RoHS/RoHS II Compliant

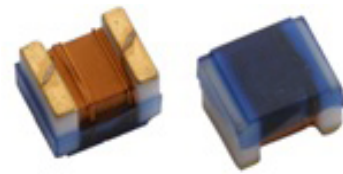

1.80 x 1.12 x 1.02mm

Part Number AISC-0603HP- Inductance Code	Inductance	Tolerance	Min. Quality Factor	L/Q Test Freq.	Typ. Quality Factor @ 250MHz /900MHz	Max. DC Resistance	Max. Rated Current	Min. Self-resonant Frequency
Units	nH	-	-	MHz		Ω	mA	MHz
Symbol	L	-	Q	Freq.		DCR	I _r	S.R.F
AISC-0603HP-75N	75	G, J, K	34	150	46/35	0.42	550	1700
AISC-0603HP-82N	82	G, J, K	34	150	51/36	0.46	510	1600
AISC-0603HP-91N	91	G, J, K	34	150	48/33	0.42	550	1500
AISC-0603HP-R10	100	G, J, K	34	150	52/32	0.54	470	1400
AISC-0603HP-R11	110	G, J, K	33	150	46/29	0.54	470	1350
AISC-0603HP-R12	120	G, J, K	33	150	50/33	0.65	420	1300
AISC-0603HP-R15	150	G, J, K	30	150	46/22	0.82	390	1150
AISC-0603HP-R18	180	G, J, K	28	100	48/20	1.2	320	1050
AISC-0603HP-R20	200	G, J, K	28	100	45/10	1.3	310	1000
AISC-0603HP-R21	210	G, J, K	28	100	48/12	1.9	280	1000
AISC-0603HP-R22	220	G, J, K	28	100	47/16	1.9	280	950
AISC-0603HP-R25	250	G, J, K	28	100	46/-	2.0	260	900
AISC-0603HP-R27	270	G, J, K	28	100	48/-	2.2	260	900
AISC-0603HP-R30	300	G, J, K	28	100	44/-	2.7	220	780
AISC-0603HP-R33	330	G, J, K	28	100	43/-	2.9	200	750
AISC-0603HP-R36	360	G, J, K	28	100	45/-	3.8	180	720
AISC-0603HP-R39	390	G, J, K	28	100	43/-	3.8	180	700

Test Conditions

1. Inductance is measured in HP-4287A RF LCR meter with HP-16193 fixture.
2. SRF is measured in ENA E5071B network analyzer
3. RDC is measured in HP-4338B milliohmeter.
4. Definition of Rated Current (I_r): I_r is direct electric current as chip surface temperature rose just 25oC against chip initial surface temperature (T_a)

PART NUMBER IDENTIFICATION

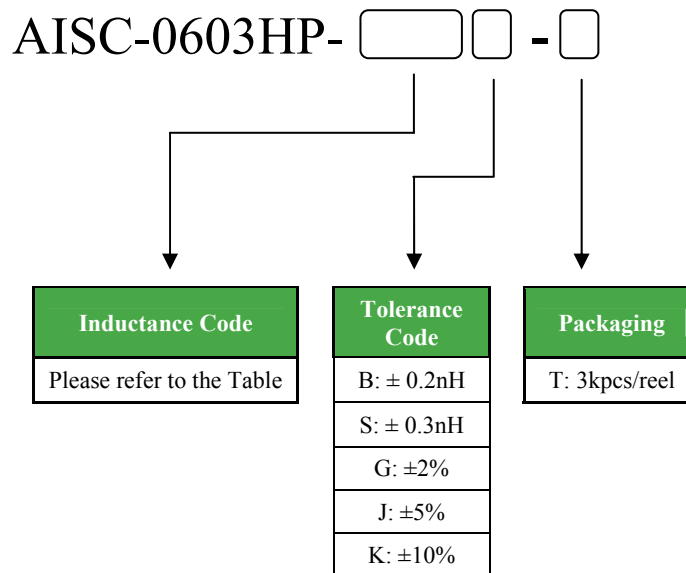

HIGH CURRENT CERAMIC WIRE WOUND INDUCTORS

AISC-0603HP



RoHS/RoHS II Compliant

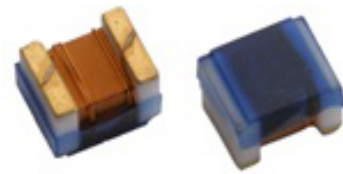

1.80 x 1.12 x 1.02mm

OUTLINE DIMENSIONS

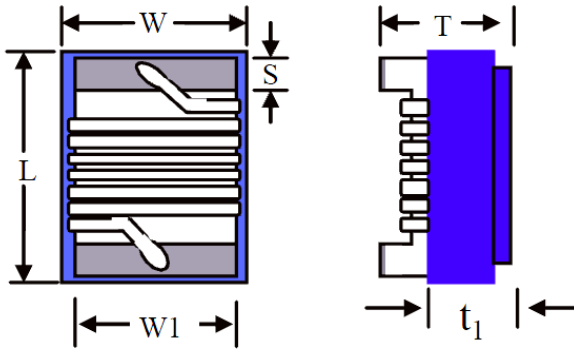

Recommended Land Pattern

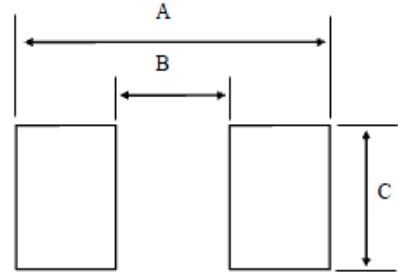

L	W	T	S	W1	t ₁
1.80 max	1.12 max	1.02 max	0.36 ± 0.10	0.76 ref	0.50 ref

A	B	C
1.92	0.64	1.27

Dimension: mm

ELECTRODE MATERIALS

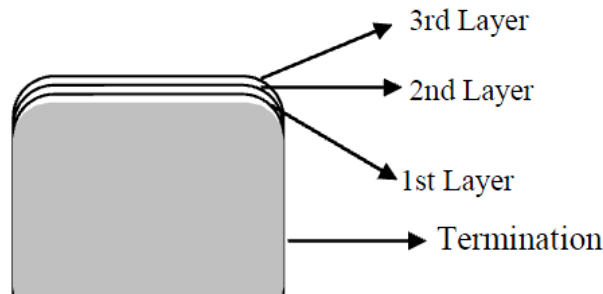

Components	Material
1 st Layer	Ag/Pd
2 nd Layer	Nickel
3 rd Layer	Tin

HIGH CURRENT CERAMIC WIRE WOUND INDUCTORS

AISC-0603HP



RoHS/RoHS II Compliant

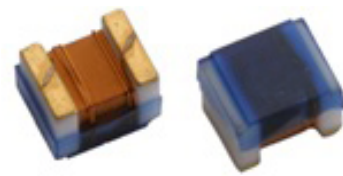

1.80 x 1.12 x 1.02mm

REFLOW PROFILE

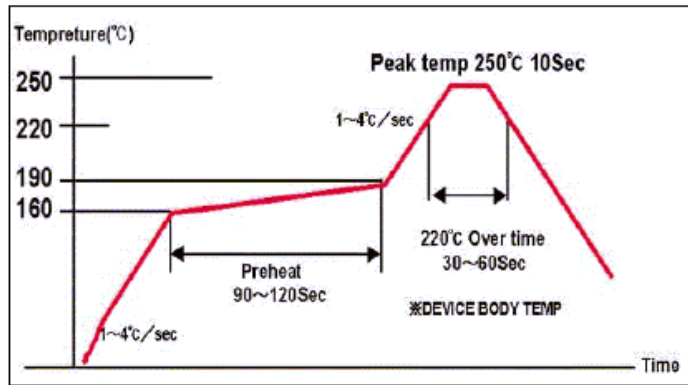

TAPE & REEL:

T= tape and reel (3,000pcs/reel)

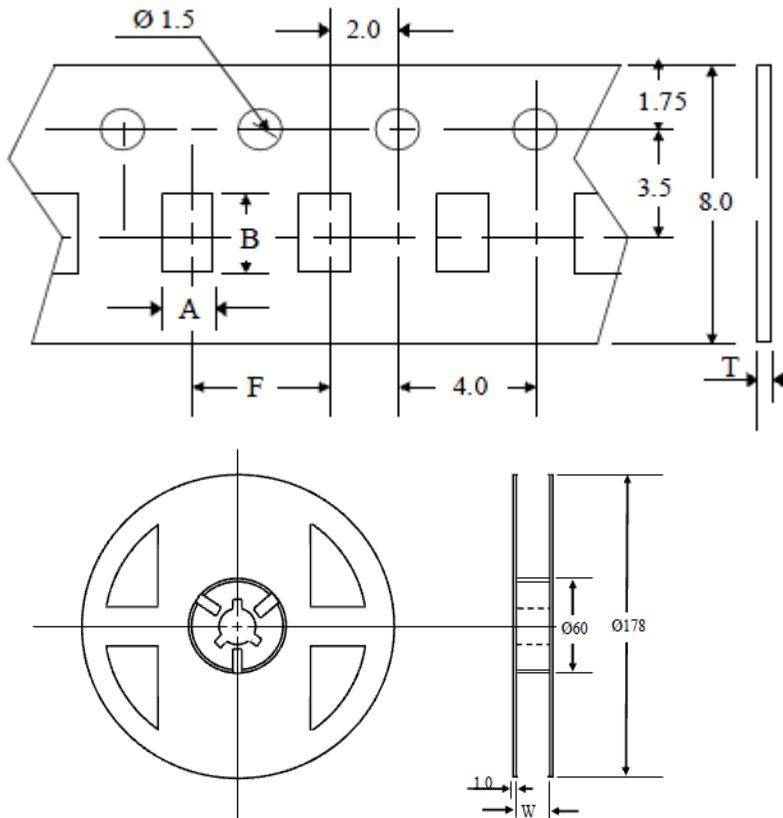

A	B	F	K	T	W
1.15	1.80	4.00	0.95	0.20	8.00

Dimension: mm

Storage period

Use the product within 12 months after delivered. Solderability should be checked if this period is exceeded.

ATTENTION: Abracon Corporation's products are COTS – Commercial-Off-The-Shelf products; suitable for Commercial, Industrial and, where designated, Automotive Applications. Abracon's products are not specifically designed for Military, Aviation, Aerospace, Life-dependant Medical applications or any application requiring high reliability where component failure could result in loss of life and/or property. For applications requiring high reliability and/or presenting an extreme operating environment, written consent and authorization from Abracon Corporation is required. Please contact Abracon Corporation for more information.

ABRACON IS
ISO 9001:2008
CERTIFIED





Visit www.abracon.com for Terms & Conditions of Sale
30332 Esperanza, Rancho Santa Margarita, California 92688
tel 949-546-8000 fax 949-546-8001 www.abracon.com

Revised: 04.06.13

Looking for pricing, stock, or lifecycle information?

Click below to explore more details on WIN SOURCE:

-  [View AISC-0603HP-7N2J-T on WIN SOURCE](#)
-  [Abracon LLC Information](#)

Optimize Your Supply Chain with WIN SOURCE Solutions

-  Global Sourcing Solution
-  Obsolete Management
-  Cost Control Management
-  Shortage Management
-  Alternative Solution
-  Excess Inventory Management