

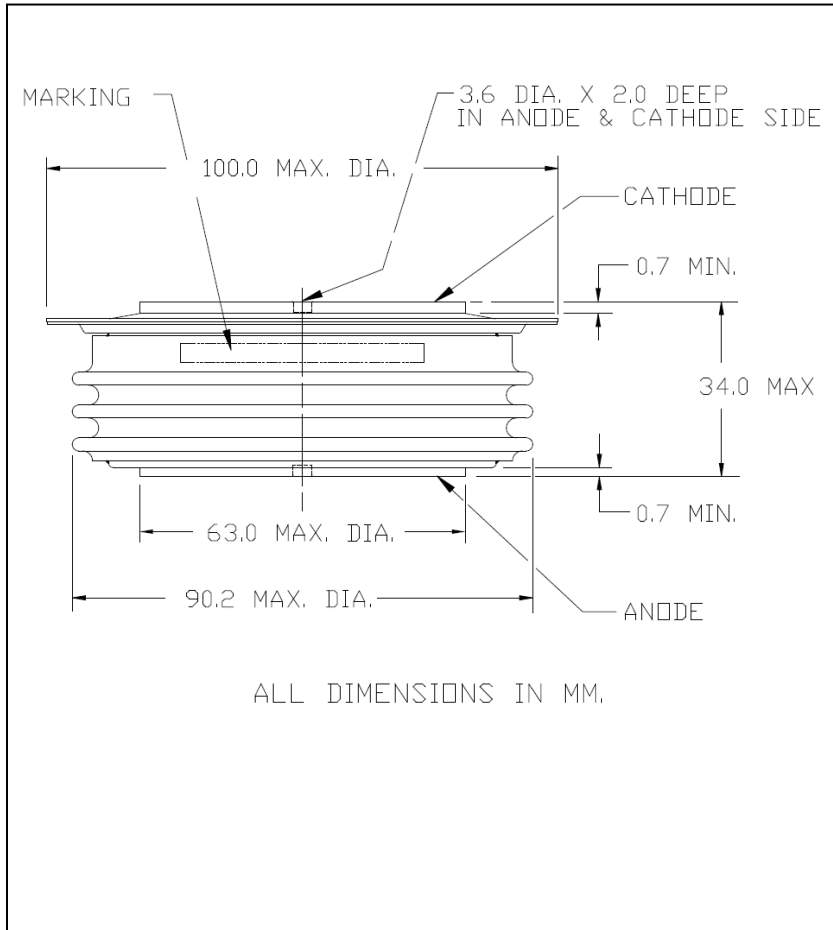

**THE DATASHEET OF
RA202825XX**





RA20 2500A (Outline Drawing)



RA20 2500A General Purpose Rectifier
2500 Amperes Average, 4200 Volts

Description:

Powerex General Purpose Rectifiers are designed for high blocking voltage capability with low forward voltage to minimize conduction losses. The hermetic Pow-R-Disc devices can be mounted using commercially available clamps and heatsinks.

Features:

- Low Forward Voltage
- Low Thermal Impedance
- Hermetic Packaging
- Excellent Surge and I^2t Ratings

Applications:

- Power Supplies
- Motor Control
- Free Wheeling Diode
- Battery Chargers
- Resistance Welding

Ordering Information:

Select the complete ten digit module part number from the table below.
Example: RA201825XX is a 1800V 2500 A General Purpose Rectifier

Type	Voltage V_{RRM} (Volts)	Current $I_{T(av)}$ (A)	Typical Recovery Time t_{RR} (μ sec)
RA20	10 through 42	25	XX
	1000V through 4200V	2500A	25 μ sec typical



**RA20
2500A**

Powerex, Inc., 173 Pavilion Lane, Youngwood, Pennsylvania 15697 (724) 925-7272
www.pwr.com

**General Purpose Rectifier
2500 Amperes Average
4200 Volts**

Absolute Maximum Ratings

Characteristics	Symbol	Units
Non-Repetitive Transient Peak Reverse Blocking Voltage	V_{RSM}	$V_{RRM} + 200V$ Volts
RMS Forward Current, $T_C = 100^\circ C$	$I_{F(RMS)}$	3920 Amperes
Average Current 180° Sine Wave, $T_C = 100^\circ C$	$I_{F(AV)}$	2500 Amperes
RMS Forward Current, $T_C = 55^\circ C$	$I_{F(RMS)}$	5810 Amperes
Average Current 180° Sine Wave, $T_C = 55^\circ C$	$I_{F(AV)}$	3700 Amperes
Peak One Cycle Surge Forward Current (Non-Repetitive) 60 Hz	I_{FSM}	28000 Amperes
Peak One Cycle Surge Forward Current (Non-Repetitive) 50 Hz	I_{FSM}	25500 Amperes
3 Cycle Surge Current	I_{FSM}	22400 Amperes
10 Cycle Surge Current	I_{FSM}	17500 Amperes
I^2t (for Fusing) for One Cycle, 60 Hz	I^2t	3.20×10^6 A ² sec
Maximum I^2t of Package ($t = 8.3$ msec)	I^2t	125×10^6 A ² sec
Operating Temperature	T_J	-40 to +150 °C
Storage Temperature	T_{stg}	-40 to +200 °C
Approximate Weight		2.1 lb.
		950 G
Mounting Force		9000 to 11000 lb.
		4100 to 5000 kg.

Information presented is based upon manufacturers testing and projected capabilities.
This information is subject to change without notice.
The manufacturer makes no claim as to the suitability of use, reliability, capability,
or future availability of this product.

Electrical Characteristics, $T_J=25^\circ\text{C}$ unless otherwise specified

Characteristics	Symbol	Test Conditions	Min.	Max.	Units
Repetitive Peak Reverse Leakage Current	I_{RRM}	$T_J=150^\circ\text{C}$, $V_R = V_{RRM}$		150	mA
Peak On-State Voltage	V_{FM}	$I_{FM}=3000\text{A}$, Duty Cycle < 0.1 %		1.25	V
Threshold Voltage, Low-level	$V_{(TO)1}$	$T_J = 150^\circ\text{C}$, $I = 15\%I_{F(AV)}$ to $\pi I_{F(AV)}$		0.74116	V
Slope Resistance, Low-level	r_{T1}			0.1320	$\text{m}\Omega$
Threshold Voltage, High-level	$V_{(TO)2}$	$T_J = 150^\circ\text{C}$, $I = \pi I_{F(AV)}$ to I_{FSM}		0.84047	V
Slope Resistance, High-level	r_{T2}			0.1194	$\text{m}\Omega$
V_{TM} Coefficients, Low-level		$T_J = 150^\circ\text{C}$, $I = 15\%I_{F(AV)}$ to $\pi I_{F(AV)}$	$A_1 =$	0.49905	
		$V_{FM} = A + B \ln I + C I + D \text{ Sqrt } I$	$B_1 =$	0.05516	
			$C_1 =$	1.483E-04	
			$D_1 =$	-0.00392	
V_{TM} Coefficients, High-level		$T_J = 150^\circ\text{C}$, $I = \pi I_{F(AV)}$ to I_{FSM}	$A_2 =$	-5.3652	
		$V_{FM} = A + B \ln I + C I + D \text{ Sqrt } I$	$B_2 =$	0.86841	
			$C_2 =$	1.378E-04	
			$D_2 =$	-0.01944	
Diode Reverse Recovery Time (Typical)	t_{rr}	$T_C = 25^\circ\text{C}$, $I_{FM} = 1500\text{A}$, $di_R/dt = -25\text{A}/\mu\text{s}$, $T_p = 190 \mu\text{s}$		25 (Typical)	μs

Thermal Characteristics

Characteristics	Symbol	Max.	Units
Maximum Thermal Resistance, Double Sided Cooling			
Junction-to-Case	$R_{\theta(J-C)}$	0.013	$^\circ\text{C}/\text{W}$
Case-to-Sink	$R_{\theta(C-S)}$	0.007	$^\circ\text{C}/\text{W}$

Maximum On-State Forward Voltage Drop
($T_j = 150^\circ\text{C}$)

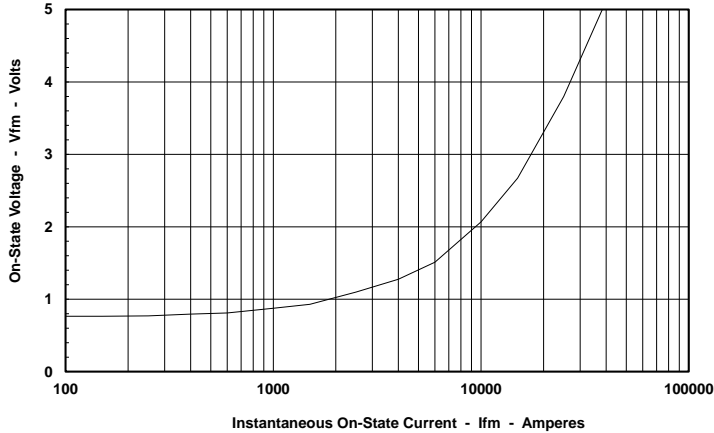

Maximum Transient Thermal Impedance
(Junction to Case)

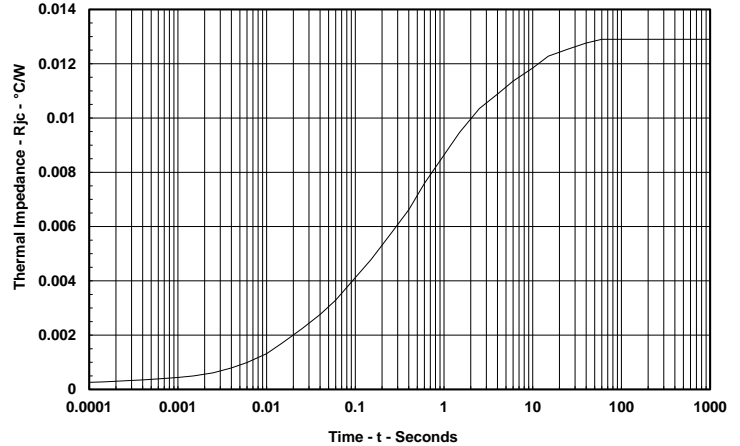

Maximum On-State Power Dissipation
(Sinusoidal Waveform)

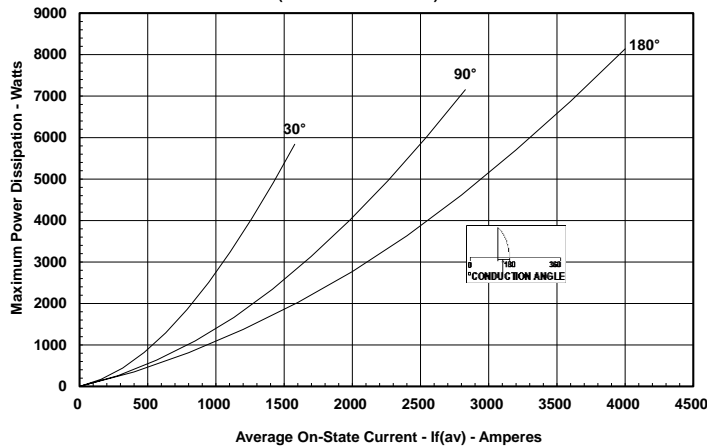

Maximum Allowable Case Temperature
(Sinusoidal Waveform)

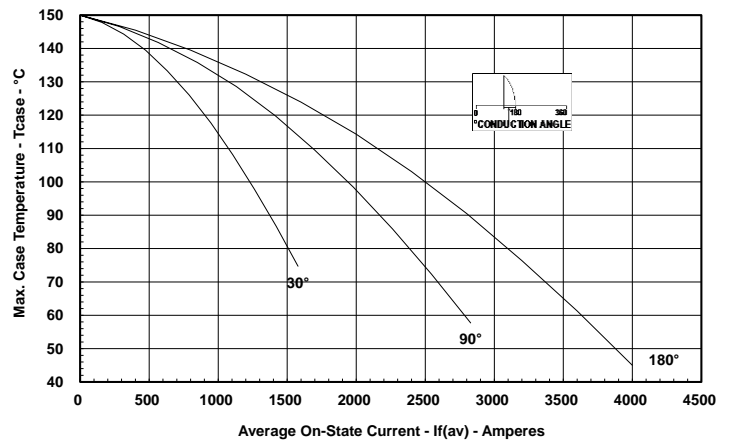

Maximum On-State Power Dissipation
(Rectangular Waveform)

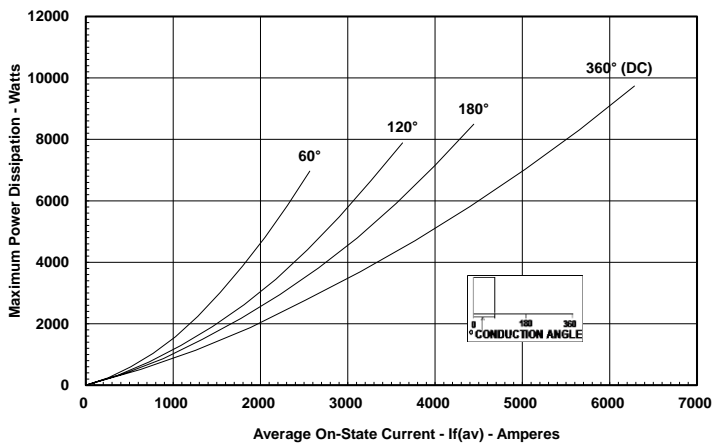

Maximum Allowable Case Temperature
(Rectangular Waveform)

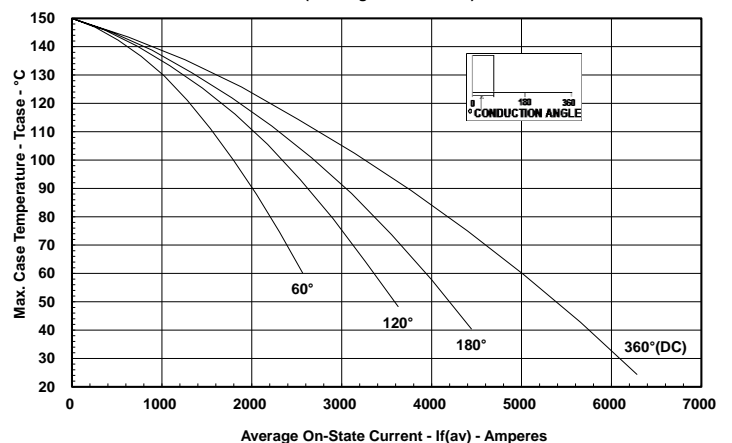

Looking for pricing, stock, or lifecycle information?

Click below to explore more details on WIN SOURCE:

 [View RA202825XX on WIN SOURCE](#)

 [Powerex Inc. Information](#)

Optimize Your Supply Chain with WIN SOURCE Solutions

-  Global Sourcing Solution
-  Obsolete Management
-  Cost Control Management
-  Shortage Management
-  Alternative Solution
-  Excess Inventory Management