



**THE DATASHEET OF
CA11402_BRITNEY-W**



Britney reflectors for Bridgelux BXRA C4500 & W3000 series of LEDs



- Specially designed for Bridgelux BXRA-C4500 and W3000 series of LEDs.
- Special care taken to make a uniform visually pleasing white or warm white illumination.
- Easy to assemble to the PCB accurately.
- Reflector is shipped with a PU foam adhesive tape of automotive grade attached for easy mounting.
- Reflector material optical grade metal and protective lacquer coated PC. Allows use of high current and temperature conditions.

REFLECTOR TYPES

NAME	ORDERING CODE	FWHM Angle
Britney Medium	CA11401_Britney-M	±14°
Britney Wide	CA11402_Britney-W	±24°

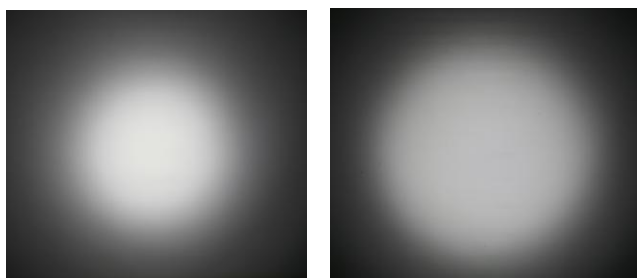

© Ledil Oy – PRELIMINARY - Subject to change without prior notice

Measurement data

Relative Intensity of CA11401_Britney-M

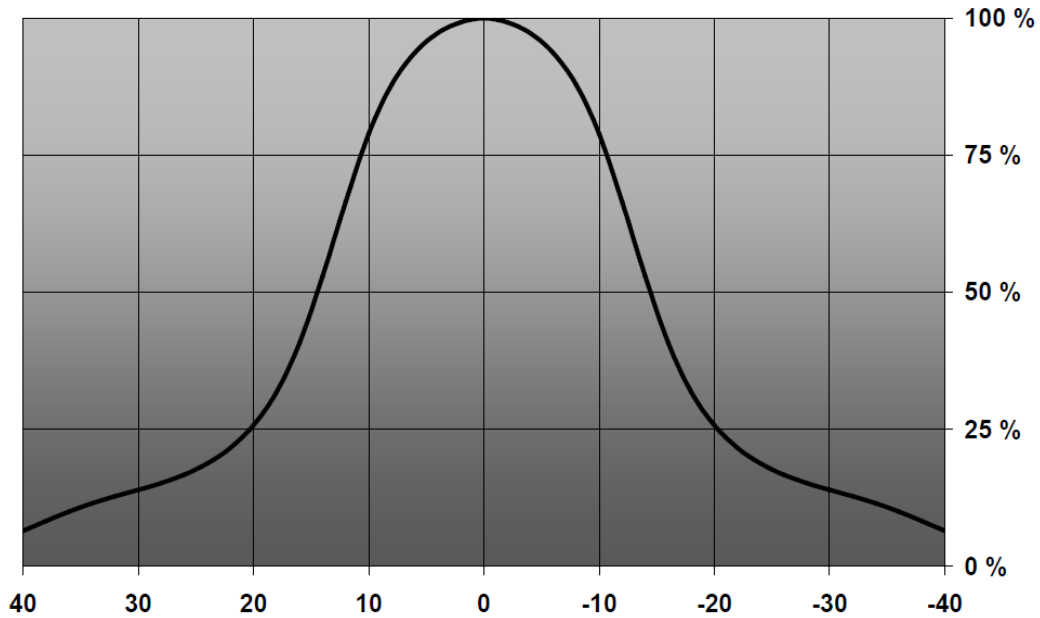

Relative Intensity of CA11402_Britney-W

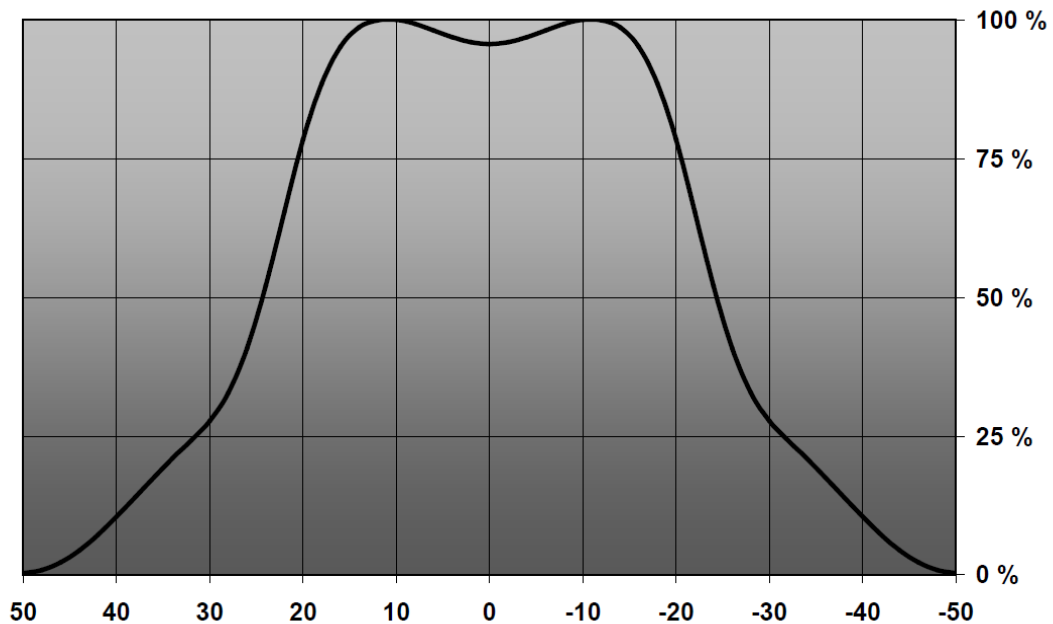

EULUMDAT & IES FILES AVAILABLE BY REQUEST

© Ledil Oy – PRELIMINARY - Subject to change without prior notice

DRAWINGS

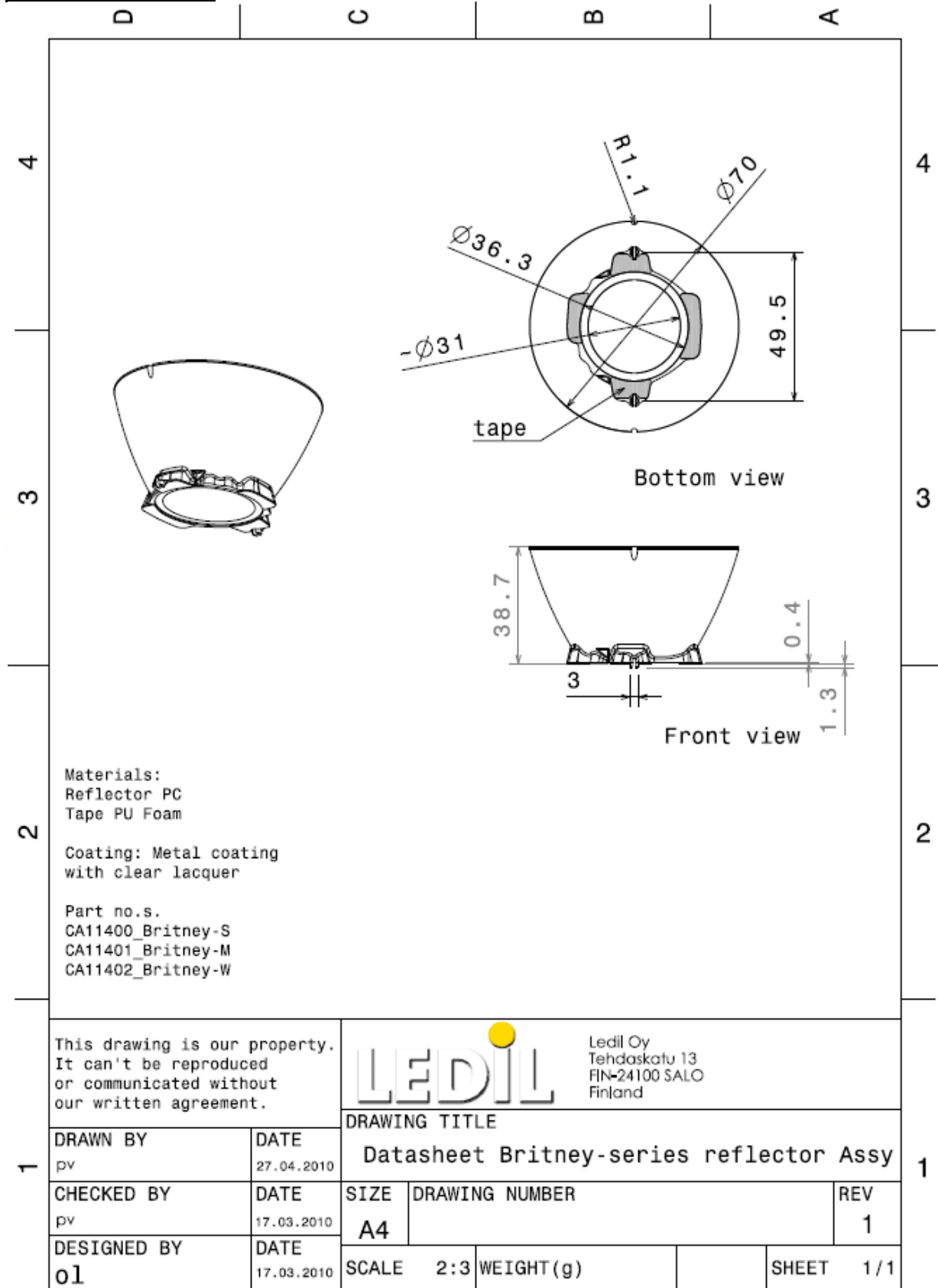





© Ledil Oy – PRELIMINARY - Subject to change without prior notice

Looking for pricing, stock, or lifecycle information?

Click below to explore more details on WIN SOURCE:

-  [View CA11402_BRITNEY-W on WIN SOURCE](#)
-  [Ledil Information](#)

Optimize Your Supply Chain with WIN SOURCE Solutions

-  Global Sourcing Solution
-  Obsolete Management
-  Cost Control Management
-  Shortage Management
-  Alternative Solution
-  Excess Inventory Management