



**THE DATASHEET OF
PVA2 OA H4 1.7N V2**



PVA Series

Short Stroke Key Switches

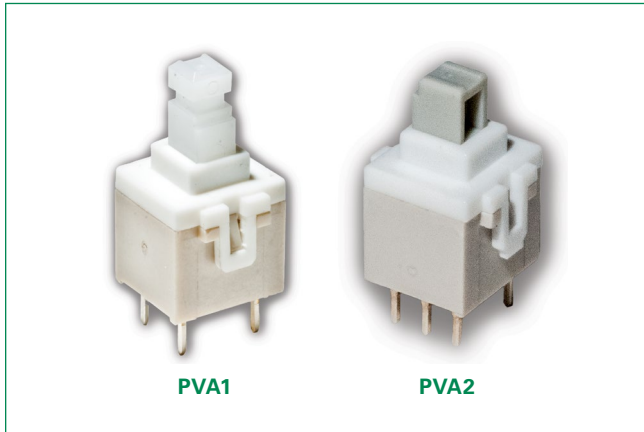

PVA1

PVA2

Construction Specifications

Function	Momentary, Push-Push
Contact Arrangement	PVA1: 2 make contacts (DPST) PVA2: 2 change over contacts (DPDT)
Switching Mode	Non-shorting
Terminals	PC Pins ¹

Mechanical Specifications

Total Travel / Latching Travel	OA: 2.4 mm EE: 2.4 / 1.5 mm
Electrical Travel	0.8 mm (1.1 for PVA2 OA H5)
Operating Force	1.2N; 1.7N; 3.5N

Process

Solderability	Wave soldering, compatible with lead free soldering profile Hand soldering, 350°C for 3 seconds
----------------------	--

Notes:

Specifications listed above are for switches with standard options. For information on specific and custom switches, please contact technical support.

Description

PVA Short Stroke keyswitches have a compact design, making them the perfect switch for control panels, industrial use and automotive applications such as air conditioning or lighting. Adapted for medium power applications, the PVA is designed with a short stroke to latch and comes in a wide variety of actuator heights to make sure it can fit the specific needs of your product.

Features & Benefits

- Compact design
- Short stroke to latch
- Wide variety of actuator heights
- Adapted for medium power applications
- RoHS compliant and compatible

Applications

- Automotive (air conditioning, lighting)
- Industrial
- Control panel

Electrical Specifications

Switching Power Max.	3 W DC
Switching Voltage Max.	32 V DC
Switching Current Max.	100 mA DC
Dielectric Strength (50 Hz / 1 min.)	100 V between open contacts, PVA2: 750 V
Operating Life	OA (momentary): $\geq 1 \times 10^5$ operations EE (push-push): $\geq 1 \times 10^5$ operations
Contact Resistance	Initial $\leq 100 \text{ m}\Omega$
Insulation Resistance	$\geq 10^{10} \Omega$
Bounce Time	$\leq 3 \text{ ms}$

Environmental Specifications

Operating Temperature	-40°C to 85°C ²
------------------------------	----------------------------

Notes:

1. "Snap-in" contacts on request, Version SNA with pins bent inside (standard)
2. With button +70°C

PVA Series

Short Stroke Key Switches



Ordering Number

Our easy build-a-switch concept allows you to mix and match options to create the switch you need. To order, select desired option from each category and place it in the appropriate box. **Some of the configurations may not be available or could require some development.**

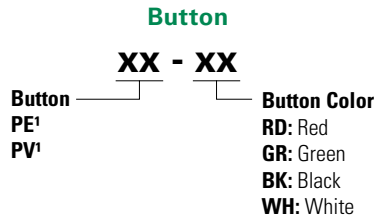
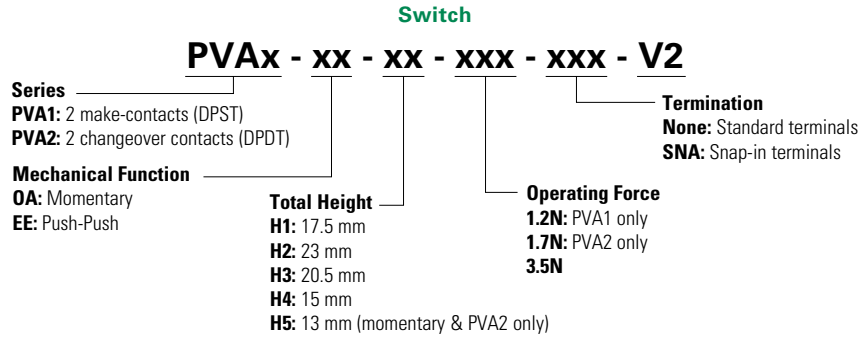

Notes:
 Buttons must be ordered separately. Shipped in bulk.
 1. Compatible with H1 and H3 actuator models only.

Series

PVA1 (DPST)

Dimensions in Inches

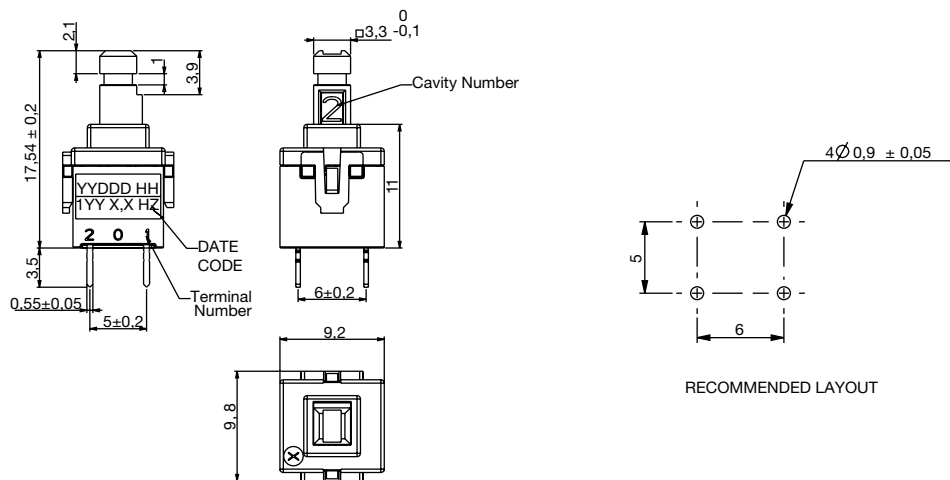

PVA Series

Short Stroke Key Switches



PVA2 (DPDT) Dimensions in Inches

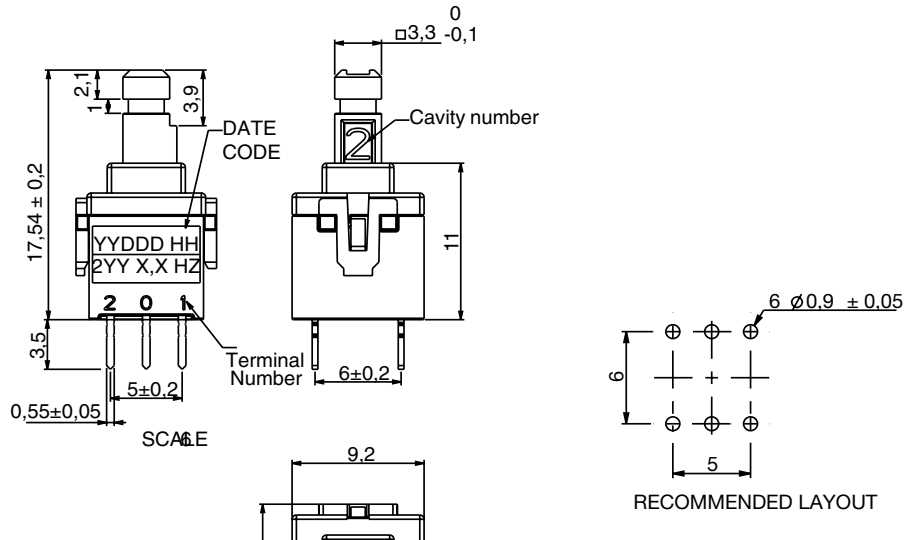

Mechanical Function

Option Code	Function
OA	Momentary
EE	Push-push

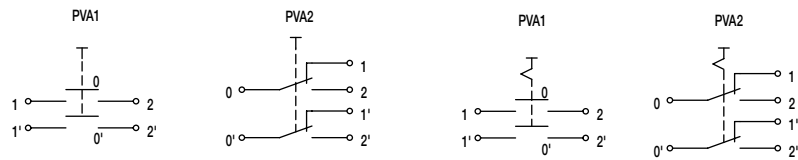

Total Height

H1 17.5 mm

H1

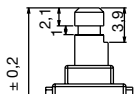

H2 23 mm

H2

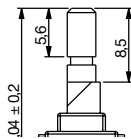

H3 20.5 mm

H3

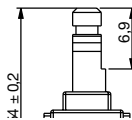

H4 15 mm

H4

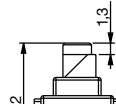

**H5 13 mm
(momentary only)**

H5

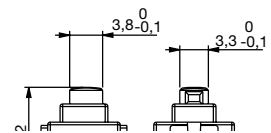

PVA Series

Short Stroke Key Switches



Operating Force

- 1.2N PVA1 only
- 1.7N PVA2 only
- 3.5N PVA1 & PVA2

Buttons

Option Code	Color
RD	Red
GY	Gray
BK	Black
WH	White

Termination

SNA with PVA1

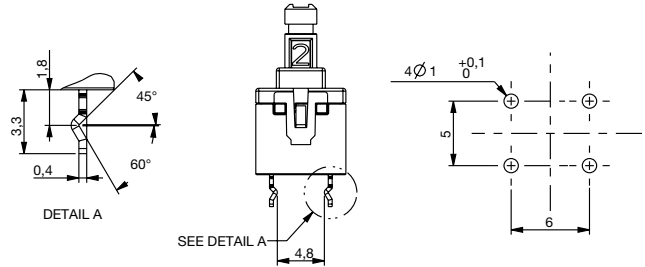

SNA with PVA2

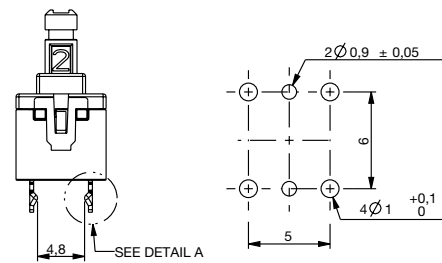

PE

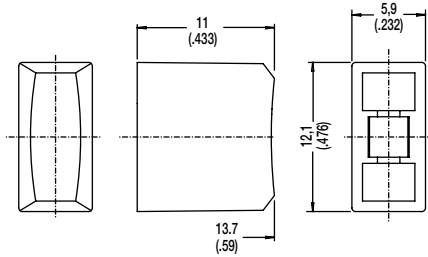

PV

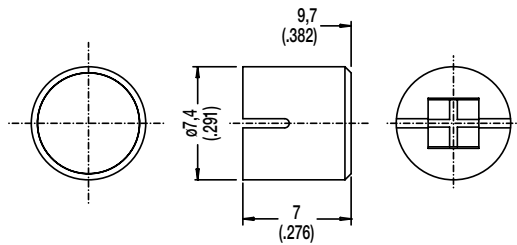



Note:
Buttons must be ordered separately. Shipped in bulk.

Disclaimer Notice - Information furnished is believed to be accurate and reliable. However, users should independently evaluate the suitability of and test each product selected for their own applications. Littelfuse products are not designed for, and may not be used in, all applications. Read complete Disclaimer Notice at <http://www.littelfuse.com/disclaimer-electronics>.

Looking for pricing, stock, or lifecycle information?

Click below to explore more details on WIN SOURCE:

-  [View PVA2 OA H4 1.7N V2 on WIN SOURCE](#)
-  [C&K Components Information](#)

Optimize Your Supply Chain with WIN SOURCE Solutions

-  Global Sourcing Solution
-  Obsolete Management
-  Cost Control Management
-  Shortage Management
-  Alternative Solution
-  Excess Inventory Management