

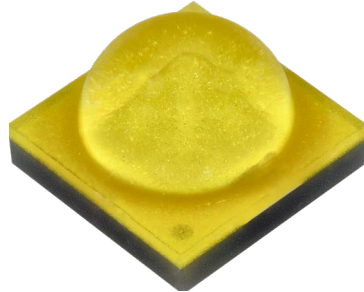

**THE DATASHEET OF  
XTEAWT-00-0000-00000BEE3**



## XLamp® XT-E LEDs



XT-E White



XT-E Royal Blue

### PRODUCT DESCRIPTION

Optimized for directional, high-lumen applications, from indoor and outdoor to portable and lamp retrofits, the XLamp® XT-E LED delivers high performance and high reliability in the industry-standard XP/XT footprint. The XT-E LED offers the benefits of the XT/XP platform – compact and proven 3.45 mm x 3.45 mm package and established ecosystem – enabling lighting manufacturers to simplify the design process and shorten time to market.

The XT-E LED is available in royal blue and white. The XT-E White LED offers a high-efficiency option. In this document, the term White denotes the white XT-E LED without regard to its efficacy. The terms Standard and High Efficacy are used when necessary to differentiate the performance of the High Efficacy XT-E LED from the XT-E LED without the high-efficiency option.

### FEATURES

- Maximum Vf for High Efficacy XT-E White: 2.85 V
- Available in 70-, 80- and 90-CRI minimum white
- Binned at 85 °C
- Available in 2200 K CCT
- Thermal resistance: White 2.8 °C/W, Royal Blue 2.0 °C/W
- Wide viewing angle: White 115°, Royal Blue 130°
- Maximum drive current: White 1.5 A, Royal Blue 1.5 A
- Electrically neutral thermal path
- Vf binning supported for XT-E White and Royal Blue
- XT-E Royal Blue sorted into 2.5-nm-wavelength bins
- Unlimited floor life at ≤ 30 °C/85% RH
- Reflow solderable - JEDEC J-STD-020C compatible
- RoHS and REACH compliant
- UL® recognized component (E349212)



**NOTE: For remote phosphor applications, a separate license to certain Cree LED patents is required.**

Cree LED / 4001 E. Hwy. 54, Suite 2000 / Durham, NC 27709 USA / +1.919.313.5330 / [www.cree-led.com](http://www.cree-led.com)

**TABLE OF CONTENTS**

Characteristics .....	3
Order Codes Suggested for New Designs - White, Standard .....	4
Order Codes Suggested for New Designs - White, High Efficacy .....	11
Order Codes Suggested for New Designs - Royal Blue .....	18
Relative Spectral Power Distribution - White.....	19
Relative Spectral Power Distribution - Royal Blue.....	19
Relative Luminous Flux vs. Junction Temperature - White .....	20
Relative Radiant Flux vs. Junction Temperature - Royal Blue .....	20
Electrical Characteristics - White, Standard .....	21
Electrical Characteristics - White, High Efficacy .....	21
Electrical Characteristics - Royal Blue .....	22
Relative Luminous Flux vs. Current - White.....	22
Relative Radiant Flux vs. Current - Royal Blue.....	23
Relative Chromaticity vs. Current - Warm White .....	23
Relative Chromaticity vs. Temperature - Warm White .....	24
Typical Spatial Distribution - White .....	24
Typical Spatial Distribution - Royal Blue .....	25
Thermal Design - White .....	25
Thermal Design - Royal Blue.....	26
Performance Groups - Luminous Flux.....	26
Performance Groups - Radiant Flux.....	27
Performance Groups - Dominant Wavelength .....	27
Performance Groups - Forward Voltage.....	27
Performance Groups - Chromaticity .....	28
Cool White Kits Plotted on ANSI Standard Chromaticity Regions.....	32
White Kits Plotted on ANSI Standard Chromaticity Regions.....	33
Warm and Neutral White Kits Plotted on ANSI Standard Chromaticity Regions .....	34
2200 K CCT White Kit Plotted on ANSI Standard Chromaticity Regions.....	35
EasyWhite® Bins Plotted on the 1931 CIE Color Space.....	35
Standard Chromaticity Kits .....	36
Bin and Order Code Formats.....	37
Reflow Soldering Characteristics.....	38
Notes .....	39
Mechanical Dimensions .....	41
Tape and Reel.....	43
Packaging.....	45
Appendix - Order Codes Not For New Designs .....	46

## CHARACTERISTICS

Characteristics	Unit	Minimum	Typical	Maximum
Thermal resistance, junction to solder point - white <sup>⊠</sup>	°C/W		2.8	
Thermal resistance, junction to solder point - royal blue <sup>⊠</sup>	°C/W		2.0	
Viewing angle (FWHM) - white	degrees		115	
Viewing angle (FWHM) - royal blue	degrees		130	
Temperature coefficient of voltage - white	mV/°C		-2.5	
Temperature coefficient of voltage - royal blue	mV/°C		-1.3	
ESD withstand voltage (HBM per Mil-Std-883D)			Class 3B	
DC forward current - white	mA			1500
DC forward current - royal blue	mA			1500
Reverse voltage	V			1
Forward voltage - white - Standard (@ 350 mA, 85 °C)	V		2.85	3.1
Forward voltage - white - High Efficacy (@ 350 mA, 85 °C)	V		2.77	2.85
Forward voltage - royal blue (@ 350 mA, 85 °C)	V		2.8	3.1
LED junction temperature	°C			150

### Note:

- ⊠ Thermal resistance measurement was performed per the JEDEC JESD51-14 standard. See the [Thermal Resistance Measurement application note](#) for more details.

**ORDER CODES SUGGESTED FOR NEW DESIGNS - WHITE, STANDARD (T<sub>j</sub> = 85 °C)**

The following tables provide order codes for XLamp Standard XT-E White LEDs. For a complete description of the order code nomenclature, please see the Bin and Order Code Formats section (page 36). For definitions of the chromaticity kits, please see the Standard Chromaticity Kits section (page 36).

Chromaticity		Minimum Luminous Flux (lm) @ 350 mA			Order Codes					
Kit	CCT	Code	Flux (lm) @ 85 °C	Flux (lm) @ 25 °C*	No Minimum CRI	70 CRI Minimum	75 CRI Typical	80 CRI Minimum	85 CRI Minimum	90 CRI Minimum
51	6200 K	S3	156	171	XTEAWT-00-0000-000000K51	XTEAWT-00-0000-00000BK51				
		S2	148	163	XTEAWT-00-0000-000000J51	XTEAWT-00-0000-00000BJ51				
		R5	139	153	XTEAWT-00-0000-000000H51	XTEAWT-00-0000-00000BH51			XTEAWT-00-0000-00000HH51	
		R4	130	143					XTEAWT-00-0000-00000HG51	
		R3	122	134					XTEAWT-00-0000-00000HF51	
53	6000 K	S3	156	171	XTEAWT-00-0000-000000K53	XTEAWT-00-0000-00000BK53				
		S2	148	163	XTEAWT-00-0000-000000J53	XTEAWT-00-0000-00000BJ53				
		R5	139	153	XTEAWT-00-0000-000000H53	XTEAWT-00-0000-00000BH53			XTEAWT-00-0000-00000HH53	
		R4	130	143					XTEAWT-00-0000-00000HG53	
		R3	122	134					XTEAWT-00-0000-00000HF53	
50	6200 K	S3	156	171	XTEAWT-00-0000-000000K50	XTEAWT-00-0000-00000BK50				
		S2	148	163	XTEAWT-00-0000-000000J50	XTEAWT-00-0000-00000BJ50				
		R5	139	153	XTEAWT-00-0000-000000H50	XTEAWT-00-0000-00000BH50			XTEAWT-00-0000-00000HH50	
		R4	130	143					XTEAWT-00-0000-00000HG50	
		R3	122	134					XTEAWT-00-0000-00000HF50	

**Notes:**

- Cree LED maintains a tolerance of ±7% on flux and power measurements, ±0.005 on chromaticity (CCx, CCy) measurements and ±2 on CRI measurements. See the Measurements section (page 39).
- XLamp XT-E LED order codes specify only a minimum flux bin and not a maximum. Cree LED may ship reels in flux bins higher than the minimum specified by the order code without advance notice. Shipments will always adhere to the chromaticity or DWL bin restrictions specified by the order code.
- Flux values @ 25 °C are calculated and for reference only.

ORDER CODES SUGGESTED FOR NEW DESIGNS - WHITE, STANDARD (T<sub>j</sub> = 85 °C) - CONTINUED

Chromaticity		Minimum Luminous Flux (lm) @ 350 mA			Order Codes					
Kit	CCT	Code	Flux (lm) @ 85 °C	Flux (lm) @ 25 °C*	No Minimum CRI	70 CRI Minimum	75 CRI Typical	80 CRI Minimum	85 CRI Minimum	90 CRI Minimum
E1	6500 K	S3	156	171	XTEAWT-00-0000-000000KE1	XTEAWT-00-0000-000000BKE1				
		S2	148	163	XTEAWT-00-0000-000000JE1	XTEAWT-00-0000-000000BJE1				
		R5	139	153	XTEAWT-00-0000-000000HE1	XTEAWT-00-0000-000000BHE1		XTEAWT-00-0000-000000HHE1		
		R4	130	143				XTEAWT-00-0000-000000HGE1		
		R3	122	134				XTEAWT-00-0000-000000HFE1		
E2	5700 K	S3	156	171	XTEAWT-00-0000-000000KE2	XTEAWT-00-0000-000000BKE2				
		S2	148	163	XTEAWT-00-0000-000000JE2	XTEAWT-00-0000-000000BJE2				
		R5	139	153	XTEAWT-00-0000-000000HE2	XTEAWT-00-0000-000000BHE2		XTEAWT-00-0000-000000HHE2		
		R4	130	143				XTEAWT-00-0000-000000HGE2		
		R3	122	134				XTEAWT-00-0000-000000HFE2		
E3	5000 K	S3	156	171	XTEAWT-00-0000-000000KE3	XTEAWT-00-0000-000000BKE3				
		S2	148	163	XTEAWT-00-0000-000000JE3	XTEAWT-00-0000-000000BJE3	XTEAWT-00-0000-000000LJE3			
		R5	139	153	XTEAWT-00-0000-000000HE3	XTEAWT-00-0000-000000BHE3	XTEAWT-00-0000-000000LHE3	XTEAWT-00-0000-000000HHE3		
		R4	130	143			XTEAWT-00-0000-000000LGE3	XTEAWT-00-0000-000000HGE3		
		R3	122	134				XTEAWT-00-0000-000000HFE3		
		R2	114	125						
		Q5	107	118					XTEAWT-00-0000-000000PDE3	XTEAWT-00-0000-000000UDE3
C1	5000 K	S3	156	171	XTEAWT-00-0000-000000KC1	XTEAWT-00-0000-000000BKC1				
		S2	148	163	XTEAWT-00-0000-000000JC1	XTEAWT-00-0000-000000BJC1	XTEAWT-00-0000-000000LJC1			
		R5	139	153	XTEAWT-00-0000-000000HC1	XTEAWT-00-0000-000000BHC1	XTEAWT-00-0000-000000LHC1			
		R4	130	143			XTEAWT-00-0000-000000LGC1			

Notes:

- Cree LED maintains a tolerance of ±7% on flux and power measurements, ±0.005 on chromaticity (CCx, CCy) measurements and ±2 on CRI measurements. See the Measurements section (page 39).
- XLamp XT-E LED order codes specify only a minimum flux bin and not a maximum. Cree LED may ship reels in flux bins higher than the minimum specified by the order code without advance notice. Shipments will always adhere to the chromaticity or DWL bin restrictions specified by the order code.
- Flux values @ 25 °C are calculated and for reference only.

ORDER CODES SUGGESTED FOR NEW DESIGNS - WHITE, STANDARD (T<sub>j</sub> = 85 °C) - CONTINUED

Chromaticity		Minimum Luminous Flux (lm) @ 350 mA			Order Codes					
Kit	CCT	Code	Flux (lm) @ 85 °C	Flux (lm) @ 25 °C*	No Minimum CRI	70 CRI Minimum	75 CRI Typical	80 CRI Minimum	85 CRI Minimum	90 CRI Minimum
F4	4750 K	S3	156	171	XTEAWT-00-0000-00000KF4	XTEAWT-00-0000-00000BKF4				
		S2	148	163	XTEAWT-00-0000-00000JF4	XTEAWT-00-0000-00000BJF4	XTEAWT-00-0000-00000LJF4			
		R5	139	153	XTEAWT-00-0000-00000HF4	XTEAWT-00-0000-00000BHF4	XTEAWT-00-0000-00000LHF4	XTEAWT-00-0000-00000HHF4		
		R4	130	143			XTEAWT-00-0000-00000LGF4	XTEAWT-00-0000-00000HGF4		
		R3	122	134				XTEAWT-00-0000-00000HFF4		
		R2	114	125				XTEAWT-00-0000-00000HEF4		
		Q5	107	118					XTEAWT-00-0000-00000PDF4	XTEAWT-00-0000-00000UDF4
		Q4	100	110					XTEAWT-00-0000-00000PCF4	XTEAWT-00-0000-00000UCF4
D1	4750 K	S3	156	171	XTEAWT-00-0000-00000KD1	XTEAWT-00-0000-00000BKD1				
		S2	148	163	XTEAWT-00-0000-00000JD1	XTEAWT-00-0000-00000BJD1	XTEAWT-00-0000-00000LJD1			
		R5	139	153	XTEAWT-00-0000-00000HD1	XTEAWT-00-0000-00000BHD1	XTEAWT-00-0000-00000LHD1			
		R4	130	143			XTEAWT-00-0000-00000LGD1			
E4	4500 K	S3	156	171	XTEAWT-00-0000-00000KE4	XTEAWT-00-0000-00000BKE4				
		S2	148	163	XTEAWT-00-0000-00000JE4	XTEAWT-00-0000-00000BJE4	XTEAWT-00-0000-00000LJE4			
		R5	139	153	XTEAWT-00-0000-00000HE4	XTEAWT-00-0000-00000BHE4	XTEAWT-00-0000-00000LHE4	XTEAWT-00-0000-00000HHE4		
		R4	130	143			XTEAWT-00-0000-00000LGE4	XTEAWT-00-0000-00000HGE4		
		R3	122	134				XTEAWT-00-0000-00000HFE4		
		R2	114	125				XTEAWT-00-0000-00000HEE4		
		Q5	107	118					XTEAWT-00-0000-00000PDE4	XTEAWT-00-0000-00000UDE4
		Q4	100	110					XTEAWT-00-0000-00000PCE4	XTEAWT-00-0000-00000UCE4

Notes:

- Cree LED maintains a tolerance of ±7% on flux and power measurements, ±0.005 on chromaticity (CCx, CCy) measurements and ±2 on CRI measurements. See the Measurements section (page 39).
- XLamp XT-E LED order codes specify only a minimum flux bin and not a maximum. Cree LED may ship reels in flux bins higher than the minimum specified by the order code without advance notice. Shipments will always adhere to the chromaticity or DWL bin restrictions specified by the order code.
- Flux values @ 25 °C are calculated and for reference only.

ORDER CODES SUGGESTED FOR NEW DESIGNS - WHITE, STANDARD (T<sub>j</sub> = 85 °C) - CONTINUED

Chromaticity		Minimum Luminous Flux (lm) @ 350 mA			Order Codes					
Kit	CCT	Code	Flux (lm) @ 85 °C	Flux (lm) @ 25 °C*	No Minimum CRI	70 CRI Minimum	75 CRI Typical	80 CRI Minimum	85 CRI Minimum	90 CRI Minimum
D2	4500 K	S3	156	171	XTEAWT-00-0000-00000KD2	XTEAWT-00-0000-00000BKD2				
		S2	148	163	XTEAWT-00-0000-00000JD2	XTEAWT-00-0000-00000BJD2				
		R5	139	153	XTEAWT-00-0000-00000HD2	XTEAWT-00-0000-00000BHD2	XTEAWT-00-0000-00000LHD2			
		R4	130	143			XTEAWT-00-0000-00000LGD2			
C2	4500 K	S3	156	171	XTEAWT-00-0000-00000KC2	XTEAWT-00-0000-00000BKC2				
		S2	148	163	XTEAWT-00-0000-00000JC2	XTEAWT-00-0000-00000BJC2	XTEAWT-00-0000-00000LJC2			
		R5	139	153	XTEAWT-00-0000-00000HC2	XTEAWT-00-0000-00000BHC2	XTEAWT-00-0000-00000LHC2			
		R4	130	143			XTEAWT-00-0000-00000LGC2			
C3	4300 K	S3	156	171	XTEAWT-00-0000-00000KC3	XTEAWT-00-0000-00000BKC3				
		S2	148	163	XTEAWT-00-0000-00000JC3	XTEAWT-00-0000-00000BJC3	XTEAWT-00-0000-00000LJC3			
		R5	139	153	XTEAWT-00-0000-00000HC3	XTEAWT-00-0000-00000BHC3	XTEAWT-00-0000-00000LHC3			
		R4	130	143			XTEAWT-00-0000-00000LGC3			
F5	4250 K	S3	156	171	XTEAWT-00-0000-00000KF5					
		S2	148	163	XTEAWT-00-0000-00000JF5	XTEAWT-00-0000-00000BJF5				
		R5	139	153	XTEAWT-00-0000-00000HF5	XTEAWT-00-0000-00000BHF5	XTEAWT-00-0000-00000LHF5			
		R4	130	143			XTEAWT-00-0000-00000LGF5	XTEAWT-00-0000-00000HGF5		
		R3	122	134			XTEAWT-00-0000-00000LFF5	XTEAWT-00-0000-00000HFF5		
		R2	114	125				XTEAWT-00-0000-00000HEF5		
		Q5	107	118						
		Q4	100	110					XTEAWT-00-0000-00000PCF5	XTEAWT-00-0000-00000UCF5
		Q3	93.9	103					XTEAWT-00-0000-00000PBF5	XTEAWT-00-0000-00000UBF5

Notes:

- Cree LED maintains a tolerance of ±7% on flux and power measurements, ±0.005 on chromaticity (CCx, CCy) measurements and ±2 on CRI measurements. See the Measurements section (page 39).
- XLamp XT-E LED order codes specify only a minimum flux bin and not a maximum. Cree LED may ship reels in flux bins higher than the minimum specified by the order code without advance notice. Shipments will always adhere to the chromaticity or DWL bin restrictions specified by the order code.
- Flux values @ 25 °C are calculated and for reference only.

ORDER CODES SUGGESTED FOR NEW DESIGNS - WHITE, STANDARD (T<sub>j</sub> = 85 °C) - CONTINUED

Chromaticity		Minimum Luminous Flux (lm) @ 350 mA			Order Codes					
Kit	CCT	Code	Flux (lm) @ 85 °C	Flux (lm) @ 25 °C*	No Minimum CRI	70 CRI Minimum	75 CRI Typical	80 CRI Minimum	85 CRI Minimum	90 CRI Minimum
E5	4000 K	S3	156	171	XTEAWT-00-0000-000000KE5	XTEAWT-00-0000-000000BKE5				
		S2	148	163	XTEAWT-00-0000-000000JE5	XTEAWT-00-0000-000000BJE5				
		R5	139	153	XTEAWT-00-0000-000000HE5	XTEAWT-00-0000-000000BHE5	XTEAWT-00-0000-000000LHE5			
		R4	130	143			XTEAWT-00-0000-000000LGE5	XTEAWT-00-0000-000000HGE5		
		R3	122	134			XTEAWT-00-0000-000000LFE5	XTEAWT-00-0000-000000HFE5		
		R2	114	125				XTEAWT-00-0000-000000HEE5		
		Q5	107	118						
		Q4	100	110					XTEAWT-00-0000-000000PCE5	XTEAWT-00-0000-000000UCE5
		Q3	93.9	103					XTEAWT-00-0000-000000PBE5	XTEAWT-00-0000-000000UBE5
F6	3750 K	R5	139	153	XTEAWT-00-0000-000000HF6	XTEAWT-00-0000-000000BHF6	XTEAWT-00-0000-000000LHF6			
		R4	130	143	XTEAWT-00-0000-000000GF6	XTEAWT-00-0000-000000BGF6	XTEAWT-00-0000-000000LGF6			
		R3	122	134	XTEAWT-00-0000-000000FF6	XTEAWT-00-0000-000000BFF6	XTEAWT-00-0000-000000LFF6	XTEAWT-00-0000-000000HFF6		
		R2	114	125				XTEAWT-00-0000-000000HEF6		
		Q5	107	118				XTEAWT-00-0000-000000HDF6		
		Q4	100	110					XTEAWT-00-0000-000000PCF6	XTEAWT-00-0000-000000UCF6
		Q3	93.9	103					XTEAWT-00-0000-000000PBF6	XTEAWT-00-0000-000000UBF6

Notes:

- Cree LED maintains a tolerance of ±7% on flux and power measurements, ±0.005 on chromaticity (CCx, CCy) measurements and ±2 on CRI measurements. See the Measurements section (page 39).
- XLamp XT-E LED order codes specify only a minimum flux bin and not a maximum. Cree LED may ship reels in flux bins higher than the minimum specified by the order code without advance notice. Shipments will always adhere to the chromaticity or DWL bin restrictions specified by the order code.
- Flux values @ 25 °C are calculated and for reference only.

ORDER CODES SUGGESTED FOR NEW DESIGNS - WHITE, STANDARD (T<sub>j</sub> = 85 °C) - CONTINUED

Chromaticity		Minimum Luminous Flux (lm) @ 350 mA			Order Codes					
Kit	CCT	Code	Flux (lm) @ 85 °C	Flux (lm) @ 25 °C*	No Minimum CRI	70 CRI Minimum	75 CRI Typical	80 CRI Minimum	85 CRI Minimum	90 CRI Minimum
E6	3500 K	R5	139	153	XTEAWT-00-0000-000000HE6	XTEAWT-00-0000-000000BHE6	XTEAWT-00-0000-000000LHE6			
		R4	130	143	XTEAWT-00-0000-000000GE6	XTEAWT-00-0000-000000BGE6	XTEAWT-00-0000-000000LGE6			
		R3	122	134	XTEAWT-00-0000-000000FE6	XTEAWT-00-0000-000000BFE6	XTEAWT-00-0000-000000LFE6	XTEAWT-00-0000-000000HFE6		
		R2	114	125				XTEAWT-00-0000-000000HEE6		
		Q5	107	118				XTEAWT-00-0000-000000HDE6		
		Q4	100	110					XTEAWT-00-0000-000000PCE6	XTEAWT-00-0000-000000UCE6
		Q3	93.9	103					XTEAWT-00-0000-000000PBE6	XTEAWT-00-0000-000000UBE6
F7	3250 K	R4	130	143	XTEAWT-00-0000-000000GF7	XTEAWT-00-0000-000000BGF7	XTEAWT-00-0000-000000LGF7			
		R3	122	134	XTEAWT-00-0000-000000FF7	XTEAWT-00-0000-000000BFF7	XTEAWT-00-0000-000000LFF7	XTEAWT-00-0000-000000HFF7		
		R2	114	125			XTEAWT-00-0000-000000LEF7	XTEAWT-00-0000-000000HEF7		
		Q5	107	118				XTEAWT-00-0000-000000HDF7		
		Q4	100	110						
		Q3	93.9	103					XTEAWT-00-0000-000000PBF7	XTEAWT-00-0000-000000UBF7
		Q2	87.4	96.1					XTEAWT-00-0000-000000PAF7	XTEAWT-00-0000-000000UAF7
E7	3000 K	R4	130	143	XTEAWT-00-0000-000000GE7	XTEAWT-00-0000-000000BGE7	XTEAWT-00-0000-000000LGE7			
		R3	122	134	XTEAWT-00-0000-000000FE7	XTEAWT-00-0000-000000BFE7	XTEAWT-00-0000-000000LFE7	XTEAWT-00-0000-000000HFE7		
		R2	114	125			XTEAWT-00-0000-000000LEE7	XTEAWT-00-0000-000000HEE7		
		Q5	107	118				XTEAWT-00-0000-000000HDE7		
		Q4	100	110						
		Q3	93.9	103					XTEAWT-00-0000-000000PBE7	XTEAWT-00-0000-000000UBE7
		Q2	87.4	96.1					XTEAWT-00-0000-000000PAE7	XTEAWT-00-0000-000000UAE7

Notes:

- Cree LED maintains a tolerance of ±7% on flux and power measurements, ±0.005 on chromaticity (CCx, CCy) measurements and ±2 on CRI measurements. See the Measurements section (page 39).
- XLamp XT-E LED order codes specify only a minimum flux bin and not a maximum. Cree LED may ship reels in flux bins higher than the minimum specified by the order code without advance notice. Shipments will always adhere to the chromaticity or DWL bin restrictions specified by the order code.
- Flux values @ 25 °C are calculated and for reference only.

ORDER CODES SUGGESTED FOR NEW DESIGNS - WHITE, STANDARD (T<sub>j</sub> = 85 °C) - CONTINUED

Chromaticity		Minimum Luminous Flux (lm) @ 350 mA			Order Codes					
Kit	CCT	Code	Flux (lm) @ 85 °C	Flux (lm) @ 25 °C*	No Minimum CRI	70 CRI Minimum	75 CRI Typical	80 CRI Minimum	85 CRI Minimum	90 CRI Minimum
F8	2850 K	R3	122	134	XTEAWT-00-0000-000000FF8	XTEAWT-00-0000-000000BFF8	XTEAWT-00-0000-000000LFF8			
		R2	114	125	XTEAWT-00-0000-000000EF8	XTEAWT-00-0000-000000BEF8	XTEAWT-00-0000-000000LEF8	XTEAWT-00-0000-000000HEF8		
		Q5	107	118			XTEAWT-00-0000-000000LDF8	XTEAWT-00-0000-000000HDF8		
		Q4	100	110						
		Q3	93.9	103					XTEAWT-00-0000-000000PBF8	
		Q2	87.4	96.1					XTEAWT-00-0000-000000PAF8	XTEAWT-00-0000-000000UAF8
		P4	80.6	88.6						XTEAWT-00-0000-000000U9F8
E8	2700 K	R3	122	134	XTEAWT-00-0000-000000FE8	XTEAWT-00-0000-000000BFE8	XTEAWT-00-0000-000000LFE8			
		R2	114	125	XTEAWT-00-0000-000000EE8	XTEAWT-00-0000-000000BEE8	XTEAWT-00-0000-000000LEE8	XTEAWT-00-0000-000000HEE8		
		Q5	107	118			XTEAWT-00-0000-000000LDE8	XTEAWT-00-0000-000000HDE8		
		Q4	100	110						
		Q3	93.9	103					XTEAWT-00-0000-000000PBE8	
		Q2	87.4	96.1					XTEAWT-00-0000-000000PAE8	XTEAWT-00-0000-000000UAE8
		P4	80.6	88.6						XTEAWT-00-0000-000000U9E8

Notes:

- Cree LED maintains a tolerance of ±7% on flux and power measurements, ±0.005 on chromaticity (CCx, CCy) measurements and ±2 on CRI measurements. See the Measurements section (page 39).
- XLamp XT-E LED order codes specify only a minimum flux bin and not a maximum. Cree LED may ship reels in flux bins higher than the minimum specified by the order code without advance notice. Shipments will always adhere to the chromaticity or DWL bin restrictions specified by the order code.
- Flux values @ 25 °C are calculated and for reference only.

**ORDER CODES SUGGESTED FOR NEW DESIGNS - WHITE, HIGH EFFICACY (T<sub>j</sub> = 85 °C)**

The following table provides order codes for XLamp High-Efficacy XT-E White LEDs. For a complete description of the order code nomenclature, please see the Bin and Order Code Formats section (page 36). For definitions of the chromaticity kits, please see the Standard Chromaticity Kits section (page 36).

Chromaticity		Minimum Luminous Flux (lm) @ 350 mA			Order Codes			
Kit	CCT	Code	Flux (lm) @ 85 °C	Flux (lm) @ 25 °C*	No Minimum CRI	70 CRI Minimum	80 CRI Minimum	90 CRI Minimum
51	6200 K	S5	172	189	XTEAWT-E0-0000-000000M51	XTEAWT-E0-0000-000000BM51		
		S4	164	180	XTEAWT-E0-0000-000000L51	XTEAWT-E0-0000-000000BL51		
		S3	156	171	XTEAWT-E0-0000-000000K51	XTEAWT-E0-0000-000000BK51	XTEAWT-E0-0000-000000HK51	
		S2	148	163			XTEAWT-E0-0000-000000HJ51	
		R5	139	153			XTEAWT-E0-0000-000000HH51	
53	6000 K	S5	172	189	XTEAWT-E0-0000-000000M53	XTEAWT-E0-0000-000000BM53		
		S4	164	180	XTEAWT-E0-0000-000000L53	XTEAWT-E0-0000-000000BL53		
		S3	156	171	XTEAWT-E0-0000-000000K53	XTEAWT-E0-0000-000000BK53	XTEAWT-E0-0000-000000HK53	
		S2	148	163			XTEAWT-E0-0000-000000HJ53	
		R5	139	153			XTEAWT-E0-0000-000000HH53	
50	6200 K	S5	172	189	XTEAWT-E0-0000-000000M50	XTEAWT-E0-0000-000000BM50		
		S4	164	180	XTEAWT-E0-0000-000000L50	XTEAWT-E0-0000-000000BL50		
		S3	156	171	XTEAWT-E0-0000-000000K50	XTEAWT-E0-0000-000000BK50	XTEAWT-E0-0000-000000HK50	
		S2	148	163			XTEAWT-E0-0000-000000HJ50	
		R5	139	153			XTEAWT-E0-0000-000000HH50	
E1	6500 K	S5	172	189	XTEAWT-E0-0000-000000ME1	XTEAWT-E0-0000-000000BME1		
		S4	164	180	XTEAWT-E0-0000-000000LE1	XTEAWT-E0-0000-000000BLE1		
		S3	156	171	XTEAWT-E0-0000-000000KE1	XTEAWT-E0-0000-000000BKE1	XTEAWT-E0-0000-000000HKE1	
		S2	148	163			XTEAWT-E0-0000-000000HJE1	
		R5	139	153			XTEAWT-E0-0000-000000HHE1	
1E	6500 K	S5	172	189	XTEAWT-E0-0000-000000M1E	XTEAWT-E0-0000-000000BM1E		
		S4	164	180	XTEAWT-E0-0000-000000L1E	XTEAWT-E0-0000-000000BL1E		
		S3	156	171	XTEAWT-E0-0000-000000K1E	XTEAWT-E0-0000-000000BK1E	XTEAWT-E0-0000-000000HK1E	
		S2	148	163			XTEAWT-E0-0000-000000HJ1E	
		R5	139	153			XTEAWT-E0-0000-000000HH1E	
1G	6500 K	S5	172	189	XTEAWT-E0-0000-000000M1G	XTEAWT-E0-0000-000000BM1G		
		S4	164	180	XTEAWT-E0-0000-000000L1G	XTEAWT-E0-0000-000000BL1G		
		S3	156	171	XTEAWT-E0-0000-000000K1G	XTEAWT-E0-0000-000000BK1G		

**Notes:**

- Cree LED maintains a tolerance of ±7% on flux and power measurements, ±0.005 on chromaticity (CCx, CCy) measurements and ±2 on CRI measurements. See the Measurements section (page 39).
- XLamp XT-E LED order codes specify only a minimum flux bin and not a maximum. Cree LED may ship reels in flux bins higher than the minimum specified by the order code without advance notice. Shipments will always adhere to the chromaticity or DWL bin restrictions specified by the order code.
- Flux values @ 25 °C are calculated and for reference only.

ORDER CODES SUGGESTED FOR NEW DESIGNS - WHITE, HIGH EFFICACY (T<sub>j</sub> = 85 °C) - CONTINUED

Chromaticity		Minimum Luminous Flux (lm) @ 350 mA			Order Codes			
Kit	CCT	Code	Flux (lm) @ 85 °C	Flux (lm) @ 25 °C*	No Minimum CRI	70 CRI Minimum	80 CRI Minimum	90 CRI Minimum
E2	5700 K	S5	172	189	XTEAWT-E0-0000-000000ME2	XTEAWT-E0-0000-000000BME2		
		S4	164	180	XTEAWT-E0-0000-000000LE2	XTEAWT-E0-0000-000000BLE2		
		S3	156	171	XTEAWT-E0-0000-000000KE2	XTEAWT-E0-0000-000000BKE2	XTEAWT-E0-0000-000000HKE2	
		S2	148	163			XTEAWT-E0-0000-000000HJE2	
		R5	139	153			XTEAWT-E0-0000-000000HHE2	
2E	5700 K	S5	172	189	XTEAWT-E0-0000-000000M2E	XTEAWT-E0-0000-000000BM2E		
		S4	164	180	XTEAWT-E0-0000-000000L2E	XTEAWT-E0-0000-000000BL2E		
		S3	156	171	XTEAWT-E0-0000-000000K2E	XTEAWT-E0-0000-000000BK2E	XTEAWT-E0-0000-000000HK2E	
		S2	148	163			XTEAWT-E0-0000-000000HJ2E	
		R5	139	153			XTEAWT-E0-0000-000000HH2E	
2G	5700 K	S5	172	189	XTEAWT-E0-0000-000000M2G	XTEAWT-E0-0000-000000BM2G		
		S4	164	180	XTEAWT-E0-0000-000000L2G	XTEAWT-E0-0000-000000BL2G		
		S3	156	171	XTEAWT-E0-0000-000000K2G	XTEAWT-E0-0000-000000BK2G		
E3	5000 K	S5	172	189	XTEAWT-E0-0000-000000ME3	XTEAWT-E0-0000-000000BME3		
		S4	164	180	XTEAWT-E0-0000-000000LE3	XTEAWT-E0-0000-000000BLE3		
		S3	156	171	XTEAWT-E0-0000-000000KE3	XTEAWT-E0-0000-000000BKE3	XTEAWT-E0-0000-000000HKE3	
		S2	148	163			XTEAWT-E0-0000-000000HJE3	
		R5	139	153			XTEAWT-E0-0000-000000HHE3	XTEAWT-E0-0000-000000UHE3
		R4	130	143				XTEAWT-E0-0000-000000UGE3
		R3	122	134				XTEAWT-E0-0000-000000UFE3
3E	5000 K	S5	172	189	XTEAWT-E0-0000-000000M3E	XTEAWT-E0-0000-000000BM3E		
		S4	164	180	XTEAWT-E0-0000-000000L3E	XTEAWT-E0-0000-000000BL3E		
		S3	156	171	XTEAWT-E0-0000-000000K3E	XTEAWT-E0-0000-000000BK3E	XTEAWT-E0-0000-000000HK3E	
		S2	148	163			XTEAWT-E0-0000-000000HJ3E	
		R5	139	153			XTEAWT-E0-0000-000000HH3E	XTEAWT-E0-0000-000000UH3E
		R4	130	143				XTEAWT-E0-0000-000000UG3E
		R3	122	134				XTEAWT-E0-0000-000000UF3E
3G	5000 K	S5	172	189	XTEAWT-E0-0000-000000M3G	XTEAWT-E0-0000-000000BM3G		
		S4	164	180	XTEAWT-E0-0000-000000L3G	XTEAWT-E0-0000-000000BL3G		
		S3	156	171	XTEAWT-E0-0000-000000K3G	XTEAWT-E0-0000-000000BK3G	XTEAWT-E0-0000-000000HK3G	
		S2	148	163			XTEAWT-E0-0000-000000HJ3G	
		R5	139	153			XTEAWT-E0-0000-000000HH3G	XTEAWT-E0-0000-000000UH3G
		R4	130	143				XTEAWT-E0-0000-000000UG3G
		R3	122	134				XTEAWT-E0-0000-000000UF3G

Notes:

- Cree LED maintains a tolerance of ±7% on flux and power measurements, ±0.005 on chromaticity (CCx, CCy) measurements and ±2 on CRI measurements. See the Measurements section (page 39).
- XLamp XT-E LED order codes specify only a minimum flux bin and not a maximum. Cree LED may ship reels in flux bins higher than the minimum specified by the order code without advance notice. Shipments will always adhere to the chromaticity or DWL bin restrictions specified by the order code.
- Flux values @ 25 °C are calculated and for reference only.

ORDER CODES SUGGESTED FOR NEW DESIGNS - WHITE, HIGH EFFICACY (T<sub>j</sub> = 85 °C) - CONTINUED

Chromaticity		Minimum Luminous Flux (lm) @ 350 mA			Order Codes			
Kit	CCT	Code	Flux (lm) @ 85 °C	Flux (lm) @ 25 °C*	No Minimum CRI	70 CRI Minimum	80 CRI Minimum	90 CRI Minimum
F4	4750 K	S3	156	171			XTEAWT-E0-0000-00000HKF4	
		S2	148	163			XTEAWT-E0-0000-00000HJF4	
		R5	139	153			XTEAWT-E0-0000-00000HHF4	
		R4	130	143				XTEAWT-E0-0000-00000UGF4
		R3	122	134				XTEAWT-E0-0000-00000UFF4
E4	4500 K	S5	172	189	XTEAWT-E0-0000-000000ME4	XTEAWT-E0-0000-00000BME4		
		S4	164	180	XTEAWT-E0-0000-000000LE4	XTEAWT-E0-0000-00000BLE4		
		S3	156	171	XTEAWT-E0-0000-000000KE4	XTEAWT-E0-0000-00000BKE4	XTEAWT-E0-0000-00000HKE4	
		S2	148	163			XTEAWT-E0-0000-00000HJE4	
		R5	139	153			XTEAWT-E0-0000-00000HHE4	
		R4	130	143				XTEAWT-E0-0000-00000UGE4
		R3	122	134				XTEAWT-E0-0000-00000UFE4
4E	4500 K	S5	172	189	XTEAWT-E0-0000-000000M4E	XTEAWT-E0-0000-00000BM4E		
		S4	164	180	XTEAWT-E0-0000-000000L4E	XTEAWT-E0-0000-00000BL4E		
		S3	156	171	XTEAWT-E0-0000-000000K4E	XTEAWT-E0-0000-00000BK4E	XTEAWT-E0-0000-00000HK4E	
		S2	148	163			XTEAWT-E0-0000-00000HJ4E	
		R5	139	153			XTEAWT-E0-0000-00000HH4E	
		R4	130	143				XTEAWT-E0-0000-00000UG4E
		R3	122	134				XTEAWT-E0-0000-00000UF4E
		R2	114	125				XTEAWT-E0-0000-00000UE4E
4G	4500 K	S5	172	189	XTEAWT-E0-0000-000000M4G	XTEAWT-E0-0000-00000BM4G		
		S4	164	180	XTEAWT-E0-0000-000000L4G	XTEAWT-E0-0000-00000BL4G		
		S3	156	171	XTEAWT-E0-0000-000000K4G	XTEAWT-E0-0000-00000BK4G	XTEAWT-E0-0000-00000HK4G	
		S2	148	163			XTEAWT-E0-0000-00000HJ4G	
		R5	139	153			XTEAWT-E0-0000-00000HH4G	
		R4	130	143				XTEAWT-E0-0000-00000UG4G
		R3	122	134				XTEAWT-E0-0000-00000UF4G
		R2	114	125				XTEAWT-E0-0000-00000UE4G

Notes:

- Cree LED maintains a tolerance of ±7% on flux and power measurements, ±0.005 on chromaticity (CCx, CCy) measurements and ±2 on CRI measurements. See the Measurements section (page 39).
- XLamp XT-E LED order codes specify only a minimum flux bin and not a maximum. Cree LED may ship reels in flux bins higher than the minimum specified by the order code without advance notice. Shipments will always adhere to the chromaticity or DWL bin restrictions specified by the order code.
- Flux values @ 25 °C are calculated and for reference only.

ORDER CODES SUGGESTED FOR NEW DESIGNS - WHITE, HIGH EFFICACY (T<sub>j</sub> = 85 °C) - CONTINUED

Chromaticity		Minimum Luminous Flux (lm) @ 350 mA			Order Codes			
Kit	CCT	Code	Flux (lm) @ 85 °C	Flux (lm) @ 25 °C*	No Minimum CRI	70 CRI Minimum	80 CRI Minimum	90 CRI Minimum
F5	4250 K	S5	172	189	XTEAWT-E0-0000-000000MF5	XTEAWT-E0-0000-00000BMF5		
		S4	164	180	XTEAWT-E0-0000-000000LF5	XTEAWT-E0-0000-00000BLF5		
		S3	156	171	XTEAWT-E0-0000-000000KF5	XTEAWT-E0-0000-00000BKF5	XTEAWT-E0-0000-00000HKF5	
		S2	148	163			XTEAWT-E0-0000-00000HJF5	
		R5	139	153			XTEAWT-E0-0000-00000HHF5	
		R4	130	143				XTEAWT-E0-0000-00000UGF5
		R3	122	134				XTEAWT-E0-0000-00000UFF5
		R2	114	125				XTEAWT-E0-0000-00000UEF5
E5	4000 K	S5	172	189	XTEAWT-E0-0000-000000ME5	XTEAWT-E0-0000-00000BME5		
		S4	164	180	XTEAWT-E0-0000-000000LE5	XTEAWT-E0-0000-00000BLE5		
		S3	156	171	XTEAWT-E0-0000-000000KE5	XTEAWT-E0-0000-00000BKE5	XTEAWT-E0-0000-00000HKE5	
		S2	148	163			XTEAWT-E0-0000-00000HJE5	
		R5	139	153			XTEAWT-E0-0000-00000HHE5	
		R4	130	143				XTEAWT-E0-0000-00000UGF5
		R3	122	134				XTEAWT-E0-0000-00000UFE5
		R2	114	125				XTEAWT-E0-0000-00000UEE5
5E	4000 K	S5	172	189	XTEAWT-E0-0000-000000M5E	XTEAWT-E0-0000-00000BM5E		
		S4	164	180	XTEAWT-E0-0000-000000L5E	XTEAWT-E0-0000-00000BL5E		
		S3	156	171	XTEAWT-E0-0000-000000K5E	XTEAWT-E0-0000-00000BK5E	XTEAWT-E0-0000-00000HK5E	
		S2	148	163			XTEAWT-E0-0000-00000HJ5E	
		R5	139	153			XTEAWT-E0-0000-00000HH5E	
		R4	130	143				XTEAWT-E0-0000-00000UG5E
		R3	122	134				XTEAWT-E0-0000-00000UF5E
		R2	114	125				XTEAWT-E0-0000-00000UE5E
5G	4000 K	S5	172	189	XTEAWT-E0-0000-000000M5G	XTEAWT-E0-0000-00000BM5G		
		S4	164	180	XTEAWT-E0-0000-000000L5G	XTEAWT-E0-0000-00000BL5G		
		S3	156	171	XTEAWT-E0-0000-000000K5G	XTEAWT-E0-0000-00000BK5G	XTEAWT-E0-0000-00000HK5G	
		S2	148	163			XTEAWT-E0-0000-00000HJ5G	
		R5	139	153			XTEAWT-E0-0000-00000HH5G	
		R4	130	143				XTEAWT-E0-0000-00000UG5G
		R3	122	134				XTEAWT-E0-0000-00000UF5G
		R2	114	125				XTEAWT-E0-0000-00000UE5G

Notes:

- Cree LED maintains a tolerance of ±7% on flux and power measurements, ±0.005 on chromaticity (CCx, CCy) measurements and ±2 on CRI measurements. See the Measurements section (page 39).
- XLamp XT-E LED order codes specify only a minimum flux bin and not a maximum. Cree LED may ship reels in flux bins higher than the minimum specified by the order code without advance notice. Shipments will always adhere to the chromaticity or DWL bin restrictions specified by the order code.
- Flux values @ 25 °C are calculated and for reference only.

ORDER CODES SUGGESTED FOR NEW DESIGNS - WHITE, HIGH EFFICACY (T<sub>j</sub> = 85 °C) - CONTINUED

Chromaticity		Minimum Luminous Flux (lm) @ 350 mA			Order Codes			
Kit	CCT	Code	Flux (lm) @ 85 °C	Flux (lm) @ 25 °C*	No Minimum CRI	70 CRI Minimum	80 CRI Minimum	90 CRI Minimum
F6	3750 K	S4	164	180	XTEAWT-E0-0000-000000LF6	XTEAWT-E0-0000-000000BLF6		
		S3	156	171	XTEAWT-E0-0000-000000KF6	XTEAWT-E0-0000-000000BKF6		
		S2	148	163	XTEAWT-E0-0000-000000JF6	XTEAWT-E0-0000-000000BJF6	XTEAWT-E0-0000-000000HJF6	
		R5	139	153			XTEAWT-E0-0000-000000HHF6	
		R4	130	143			XTEAWT-E0-0000-000000HGF6	
		R3	122	134				XTEAWT-E0-0000-000000UFF6
		R2	114	125				XTEAWT-E0-0000-000000UEF6
		Q5	107	118				XTEAWT-E0-0000-000000UDF6
E6	3500 K	S4	164	180	XTEAWT-E0-0000-000000LE6	XTEAWT-E0-0000-000000BLE6		
		S3	156	171	XTEAWT-E0-0000-000000KE6	XTEAWT-E0-0000-000000BKE6		
		S2	148	163	XTEAWT-E0-0000-000000JE6	XTEAWT-E0-0000-000000BJE6	XTEAWT-E0-0000-000000HJE6	
		R5	139	153			XTEAWT-E0-0000-000000HHE6	
		R4	130	143			XTEAWT-E0-0000-000000HGE6	
		R3	122	134				XTEAWT-E0-0000-000000UFE6
		R2	114	125				XTEAWT-E0-0000-000000UEE6
		Q5	107	118				XTEAWT-E0-0000-000000UDE6
6E	3500 K	S4	164	180	XTEAWT-E0-0000-000000L6E	XTEAWT-E0-0000-000000BL6E		
		S3	156	171	XTEAWT-E0-0000-000000K6E	XTEAWT-E0-0000-000000BK6E		
		S2	148	163	XTEAWT-E0-0000-000000J6E	XTEAWT-E0-0000-000000BJ6E	XTEAWT-E0-0000-000000HJ6E	
		R5	139	153			XTEAWT-E0-0000-000000HH6E	
		R4	130	143			XTEAWT-E0-0000-000000HG6E	
		R3	122	134				XTEAWT-E0-0000-000000UF6E
		R2	114	125				XTEAWT-E0-0000-000000UE6E
		Q5	107	118				XTEAWT-E0-0000-000000UD6E
6G	3500 K	S4	164	180	XTEAWT-E0-0000-000000L6G	XTEAWT-E0-0000-000000BL6G		
		S3	156	171	XTEAWT-E0-0000-000000K6G	XTEAWT-E0-0000-000000BK6G		
		S2	148	163	XTEAWT-E0-0000-000000J6G	XTEAWT-E0-0000-000000BJ6G	XTEAWT-E0-0000-000000HJ6G	
		R5	139	153			XTEAWT-E0-0000-000000HH6G	
		R4	130	143			XTEAWT-E0-0000-000000HG6G	
		R3	122	134				XTEAWT-E0-0000-000000UF6G
		R2	114	125				XTEAWT-E0-0000-000000UE6G
		Q5	107	118				XTEAWT-E0-0000-000000UD6G

Notes:

- Cree LED maintains a tolerance of ±7% on flux and power measurements, ±0.005 on chromaticity (CCx, CCy) measurements and ±2 on CRI measurements. See the Measurements section (page 39).
- XLamp XT-E LED order codes specify only a minimum flux bin and not a maximum. Cree LED may ship reels in flux bins higher than the minimum specified by the order code without advance notice. Shipments will always adhere to the chromaticity or DWL bin restrictions specified by the order code.
- Flux values @ 25 °C are calculated and for reference only.

ORDER CODES SUGGESTED FOR NEW DESIGNS - WHITE, HIGH EFFICACY (T<sub>j</sub> = 85 °C) - CONTINUED

Chromaticity		Minimum Luminous Flux (lm) @ 350 mA			Order Codes			
Kit	CCT	Code	Flux (lm) @ 85 °C	Flux (lm) @ 25 °C*	No Minimum CRI	70 CRI Minimum	80 CRI Minimum	90 CRI Minimum
F7	3250 K	S4	164	180	XTEAWT-E0-0000-000000LF7	XTEAWT-E0-0000-00000BLF7		
		S3	156	171	XTEAWT-E0-0000-000000KF7	XTEAWT-E0-0000-00000BKF7		
		S2	148	163	XTEAWT-E0-0000-000000JF7	XTEAWT-E0-0000-00000BJF7		
		R5	139	153			XTEAWT-E0-0000-00000HHF7	
		R4	130	143			XTEAWT-E0-0000-00000HGF7	
		R3	122	134			XTEAWT-E0-0000-00000HFF7	
		R2	114	125				XTEAWT-E0-0000-00000UEF7
		Q5	107	118				XTEAWT-E0-0000-00000UDF7
E7	3000 K	S4	164	180	XTEAWT-E0-0000-000000LE7	XTEAWT-E0-0000-00000BLE7		
		S3	156	171	XTEAWT-E0-0000-000000KE7	XTEAWT-E0-0000-00000BKE7		
		S2	148	163	XTEAWT-E0-0000-000000JE7	XTEAWT-E0-0000-00000BJE7		
		R5	139	153			XTEAWT-E0-0000-00000HHE7	
		R4	130	143			XTEAWT-E0-0000-00000HGE7	
		R3	122	134			XTEAWT-E0-0000-00000HFE7	
		R2	114	125				XTEAWT-E0-0000-00000UEE7
		Q5	107	118				XTEAWT-E0-0000-00000UDE7
7E	3000 K	S4	164	180	XTEAWT-E0-0000-000000L7E	XTEAWT-E0-0000-00000BL7E		
		S3	156	171	XTEAWT-E0-0000-000000K7E	XTEAWT-E0-0000-00000BK7E		
		S2	148	163	XTEAWT-E0-0000-000000J7E	XTEAWT-E0-0000-00000BJ7E		
		R5	139	153			XTEAWT-E0-0000-00000HH7E	
		R4	130	143			XTEAWT-E0-0000-00000HG7E	
		R3	122	134			XTEAWT-E0-0000-00000HF7E	
		R2	114	125				XTEAWT-E0-0000-00000UE7E
		Q5	107	118				XTEAWT-E0-0000-00000UD7E
7G	3000 K	S4	164	180	XTEAWT-E0-0000-000000L7G	XTEAWT-E0-0000-00000BL7G		
		S3	156	171	XTEAWT-E0-0000-000000K7G	XTEAWT-E0-0000-00000BK7G		
		S2	148	163	XTEAWT-E0-0000-000000J7G	XTEAWT-E0-0000-00000BJ7G		
		R5	139	153			XTEAWT-E0-0000-00000HH7G	
		R4	130	143			XTEAWT-E0-0000-00000HG7G	
		R3	122	134			XTEAWT-E0-0000-00000HF7G	
		R2	114	125				XTEAWT-E0-0000-00000UE7G
		Q5	107	118				XTEAWT-E0-0000-00000UD7G

Notes:

- Cree LED maintains a tolerance of ±7% on flux and power measurements, ±0.005 on chromaticity (CCx, CCy) measurements and ±2 on CRI measurements. See the Measurements section (page 39).
- XLamp XT-E LED order codes specify only a minimum flux bin and not a maximum. Cree LED may ship reels in flux bins higher than the minimum specified by the order code without advance notice. Shipments will always adhere to the chromaticity or DWL bin restrictions specified by the order code.
- Flux values @ 25 °C are calculated and for reference only.

ORDER CODES SUGGESTED FOR NEW DESIGNS - WHITE, HIGH EFFICACY (T<sub>j</sub> = 85 °C) - CONTINUED

Chromaticity		Minimum Luminous Flux (lm) @ 350 mA			Order Codes			
Kit	CCT	Code	Flux (lm) @ 85 °C	Flux (lm) @ 25 °C*	No Minimum CRI	70 CRI Minimum	80 CRI Minimum	90 CRI Minimum
F8	2850 K	S3	156	171	XTEAWT-E0-0000-000000KF8	XTEAWT-E0-0000-00000BK8F8		
		S2	148	163	XTEAWT-E0-0000-000000JF8	XTEAWT-E0-0000-00000BJF8		
		R5	139	153	XTEAWT-E0-0000-000000HF8	XTEAWT-E0-0000-00000BH8F8	XTEAWT-E0-0000-00000HH8F8	
		R4	130	143			XTEAWT-E0-0000-00000HG8F8	
		R3	122	134			XTEAWT-E0-0000-00000HF8	
		R2	114	125				
		Q5	107	118				XTEAWT-E0-0000-00000UD8F8
		Q4	100	110				XTEAWT-E0-0000-00000UC8F8
E8	2700 K	S3	156	171	XTEAWT-E0-0000-000000KE8	XTEAWT-E0-0000-00000BK8E8		
		S2	148	163	XTEAWT-E0-0000-000000JE8	XTEAWT-E0-0000-00000BJ8E8		
		R5	139	153	XTEAWT-E0-0000-000000HE8	XTEAWT-E0-0000-00000BH8E8	XTEAWT-E0-0000-00000HH8E8	
		R4	130	143			XTEAWT-E0-0000-00000HG8E8	
		R3	122	134			XTEAWT-E0-0000-00000HF8E8	
		R2	114	125				
		Q5	107	118				XTEAWT-E0-0000-00000UDE8
		Q4	100	110				XTEAWT-E0-0000-00000UCE8
8E	2700 K	S3	156	171	XTEAWT-E0-0000-000000K8E	XTEAWT-E0-0000-00000BK8E		
		S2	148	163	XTEAWT-E0-0000-000000J8E	XTEAWT-E0-0000-00000BJ8E		
		R5	139	153	XTEAWT-E0-0000-000000H8E	XTEAWT-E0-0000-00000BH8E	XTEAWT-E0-0000-00000HH8E	
		R4	130	143			XTEAWT-E0-0000-00000HG8E	
		R3	122	134			XTEAWT-E0-0000-00000HF8E	
		R2	114	125				
		Q5	107	118				XTEAWT-E0-0000-00000UD8E
		Q4	100	110				XTEAWT-E0-0000-00000UC8E
8G	2700 K	S3	156	171	XTEAWT-E0-0000-000000K8G	XTEAWT-E0-0000-00000BK8G		
		S2	148	163	XTEAWT-E0-0000-000000J8G	XTEAWT-E0-0000-00000BJ8G		
		R5	139	153	XTEAWT-E0-0000-000000H8G	XTEAWT-E0-0000-00000BH8G	XTEAWT-E0-0000-00000HH8G	
		R4	130	143			XTEAWT-E0-0000-00000HG8G	
		R3	122	134			XTEAWT-E0-0000-00000HF8G	
		R2	114	125				
		Q5	107	118				XTEAWT-E0-0000-00000UD8G
		Q4	100	110				XTEAWT-E0-0000-00000UC8G

- Note:
- Cree LED maintains a tolerance of ±7% on flux and power measurements, ±0.005 on chromaticity (CCx, CCy) measurements, ±2 on CRI measurements and ±1 nm on dominant wavelength measurements. See the Measurements section (page 39).
  - XT-E LED order codes specify only a minimum flux bin and not a maximum. Cree LED may ship reels in flux bins higher than the minimum specified by the order code without advance notice. Shipments will always adhere to the chromaticity or DWL bin restrictions specified by the order code.
  - Calculated Photosynthetic Photon Flux (PPF) values are for reference only.

**ORDER CODES SUGGESTED FOR NEW DESIGNS - WHITE, HIGH EFFICACY (T<sub>j</sub> = 85 °C) - CONTINUED**

Chromaticity		Minimum Luminous Flux (lm) @ 350 mA			Order Codes			
Kit	CCT	Code	Flux (lm) @ 85 °C	Flux (lm) @ 25 °C*	No Minimum CRI	70 CRI Minimum	80 CRI Minimum	90 CRI Minimum
EA	2200 K	R4	130	143		XTEAWT-E0-0000-00000BGEA		
		R3	122	134		XTEAWT-E0-0000-00000BFEA		
		R2	114	125			XTEAWT-E0-0000-00000HEEA	
		Q5	107	118			XTEAWT-E0-0000-00000HDEA	
AE	2200 K	R4	130	143		XTEAWT-E0-0000-00000BGAE		
		R3	122	134		XTEAWT-E0-0000-00000BFAE		
AG	2200 K	R4	130	143		XTEAWT-E0-0000-00000BGAG		
		R3	122	134		XTEAWT-E0-0000-00000BFAG		

**ORDER CODES SUGGESTED FOR NEW DESIGNS - ROYAL BLUE (T<sub>j</sub> = 85 °C)**

The following table provides order codes for XLamp XT-E Royal Blue LEDs. For a complete description of the order code nomenclature, please see the Bin and Order Code Formats section (page 36).

DWL Kit Codes	Dominant Wavelength Range				Order Codes, Minimum Radiant Flux @ 350 mA, T <sub>j</sub> =85 °C			
	Minimum		Maximum		600 mW - Radiant Flux Group Code 36 (Q) Calculated PPF (μmol/s) = 2.27	625 mW - Radiant Flux Group Code 37 (R) Calculated PPF (μmol/s) = 2.37	650 mW - Radiant Flux Group Code 38 (S) Calculated PPF (μmol/s) = 2.46	675 mW - Radiant Flux Group Code 39 (T) Calculated PPF (μmol/s) = 2.56
	Group	DWL (nm)	Group	DWL (nm)				
	01	D36	450	D57	465		XTEARY-00-0000-00000R01	XTEARY-00-0000-00000S01
02	D36	450	D47	460		XTEARY-00-0000-00000R02	XTEARY-00-0000-00000S02	XTEARY-00-0000-00000T02
03	D46	455	D57	465		XTEARY-00-0000-00000R03	XTEARY-00-0000-00000S03	XTEARY-00-0000-00000T03
04	D36	450	D37	455		XTEARY-00-0000-00000R04	XTEARY-00-0000-00000S04	XTEARY-00-0000-00000T04
05	D46	455	D47	460		XTEARY-00-0000-00000R05	XTEARY-00-0000-00000S05	XTEARY-00-0000-00000T05
06	D56	460	D57	465	XTEARY-00-0000-00000Q06	XTEARY-00-0000-00000R06		
07	D37	452.5	D46	457.5		XTEARY-00-0000-00000R07	XTEARY-00-0000-00000S07	XTEARY-00-0000-00000T07
08	D47	457.5	D56	462.5	XTEARY-00-0000-00000Q08	XTEARY-00-0000-00000R08	XTEARY-00-0000-00000S08	
09	D37	452.5	D56	462.5		XTEARY-00-0000-00000R09	XTEARY-00-0000-00000S09	XTEARY-00-0000-00000T09

RELATIVE SPECTRAL POWER DISTRIBUTION - WHITE

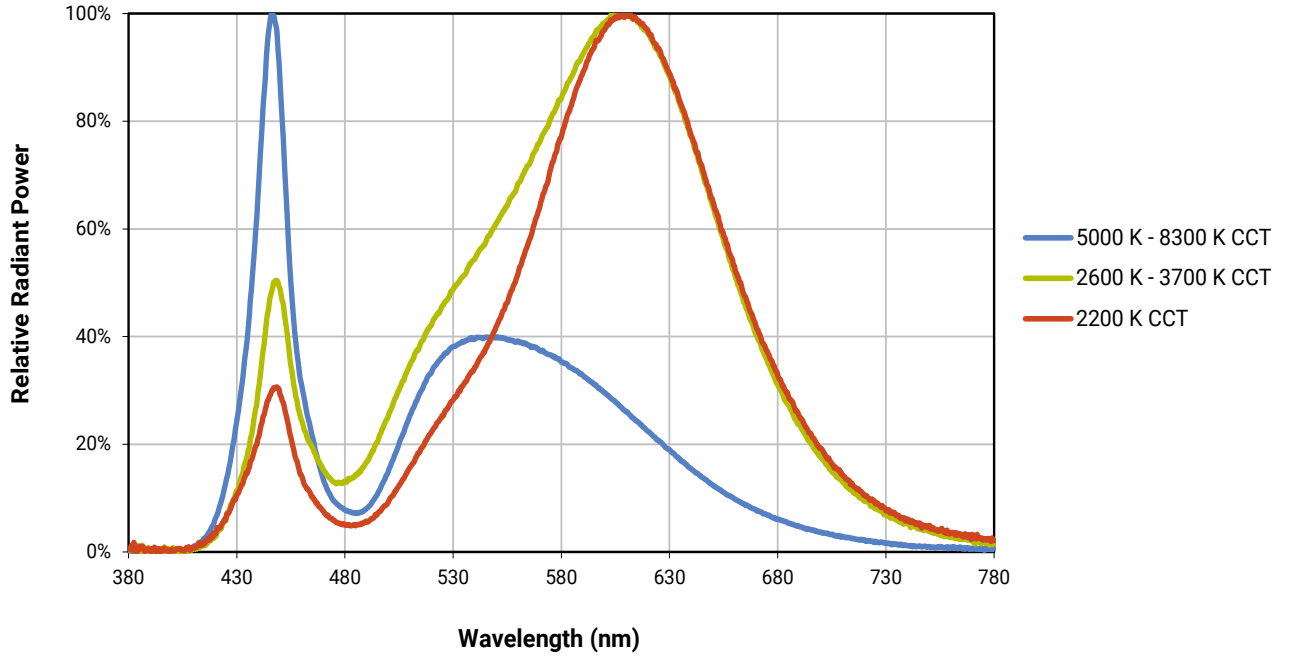

RELATIVE SPECTRAL POWER DISTRIBUTION - ROYAL BLUE

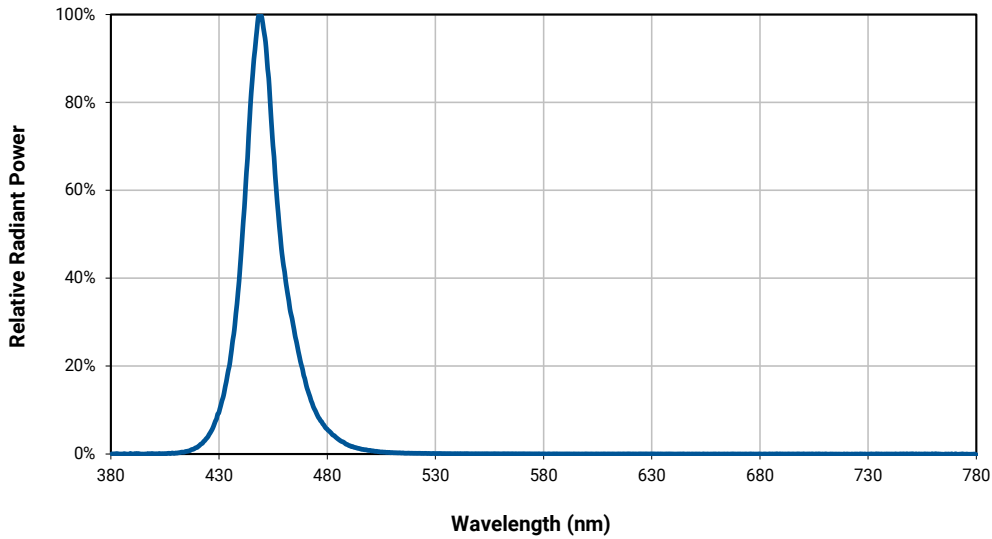

RELATIVE LUMINOUS FLUX VS. JUNCTION TEMPERATURE - WHITE ( $I_F = 350 \text{ mA}$ )

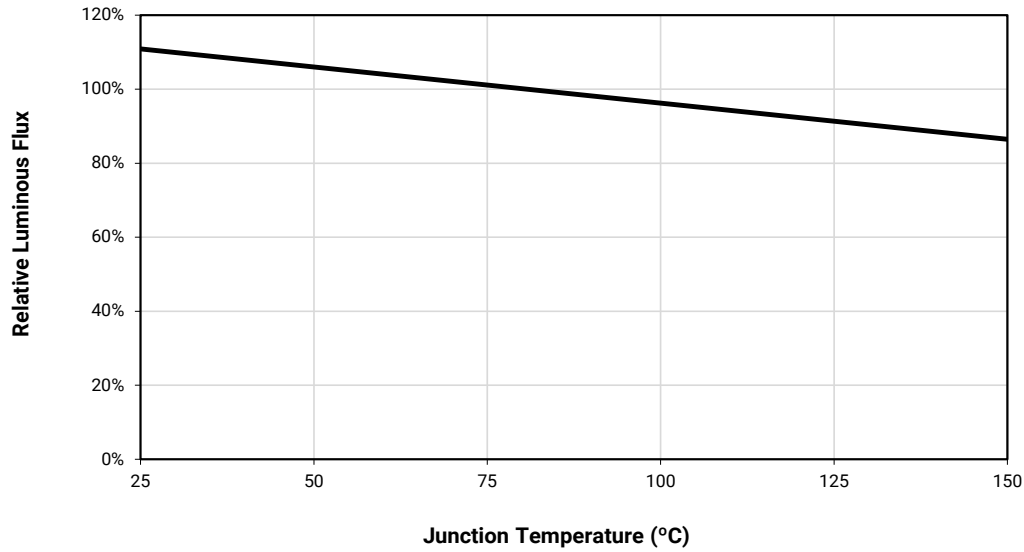

RELATIVE RADIANT FLUX VS. JUNCTION TEMPERATURE - ROYAL BLUE ( $I_F = 350 \text{ mA}$ )

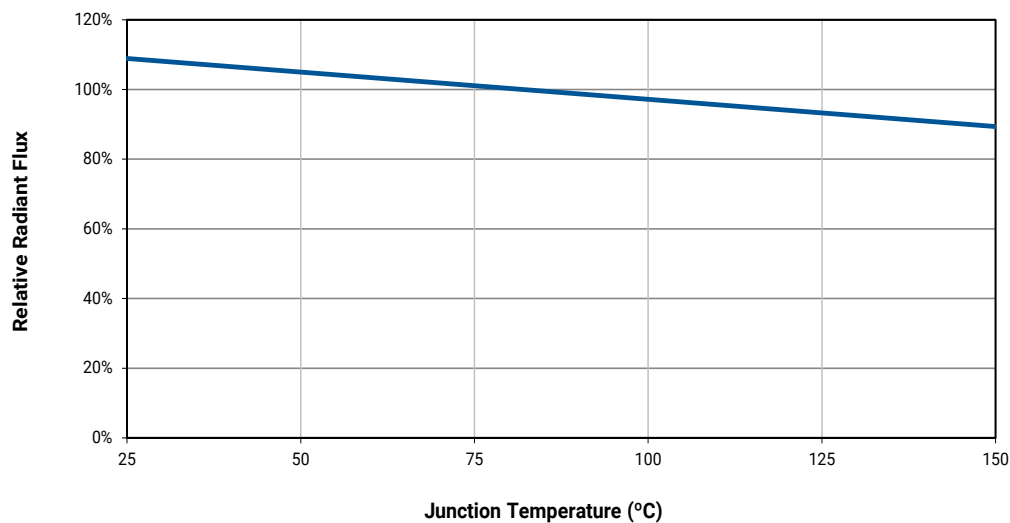

**ELECTRICAL CHARACTERISTICS - WHITE, STANDARD ( $T_j = 85^\circ\text{C}$ )**

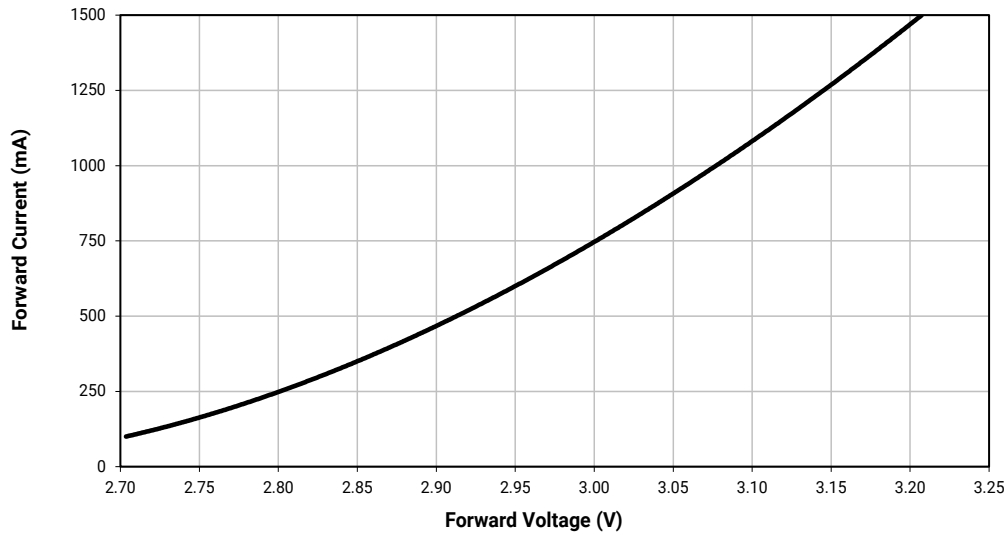

**ELECTRICAL CHARACTERISTICS - WHITE, HIGH EFFICACY ( $T_j = 85^\circ\text{C}$ )**

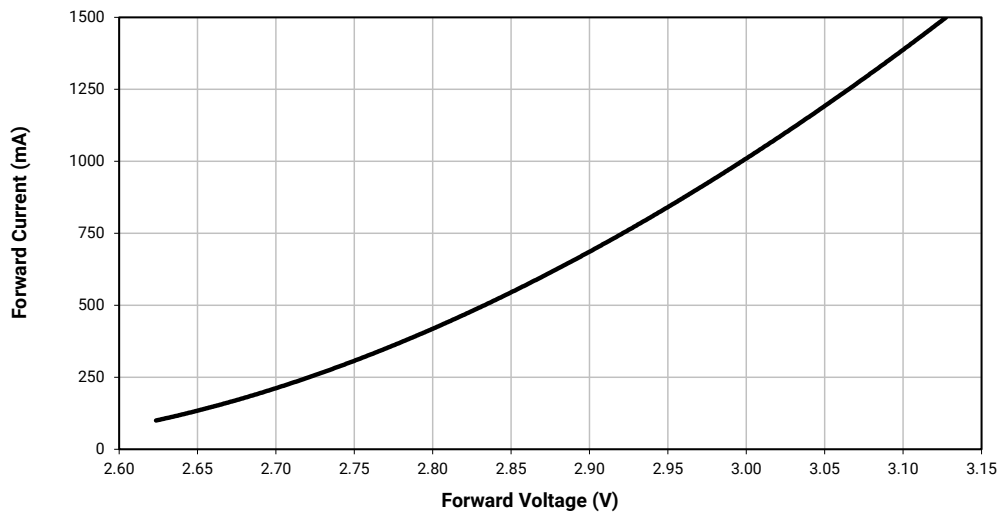

**ELECTRICAL CHARACTERISTICS - ROYAL BLUE ( $T_j = 85\text{ }^\circ\text{C}$ )**

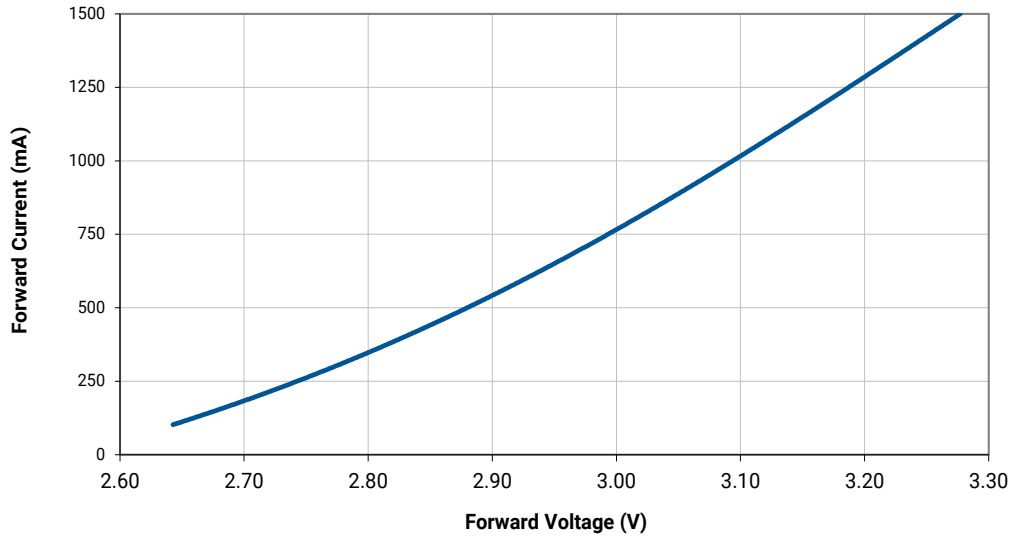

**RELATIVE LUMINOUS FLUX VS. CURRENT - WHITE ( $T_j = 85\text{ }^\circ\text{C}$ )**

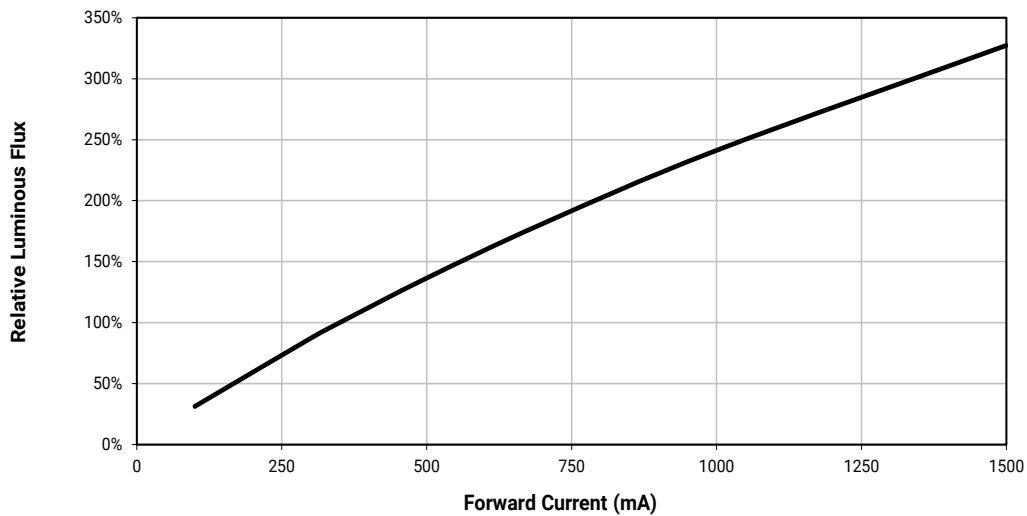

RELATIVE RADIANT FLUX VS. CURRENT - ROYAL BLUE ( $T_J = 85\text{ }^\circ\text{C}$ )

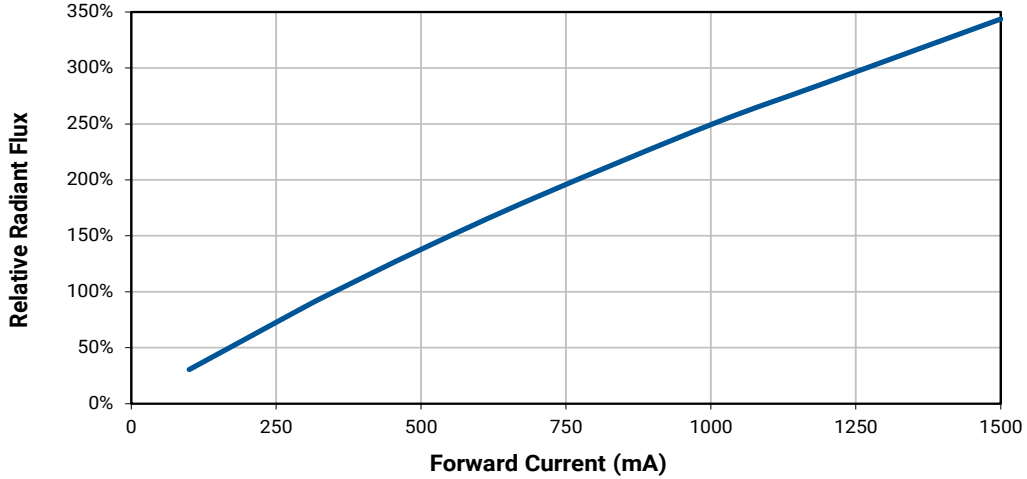

RELATIVE CHROMATICITY VS. CURRENT - WARM WHITE

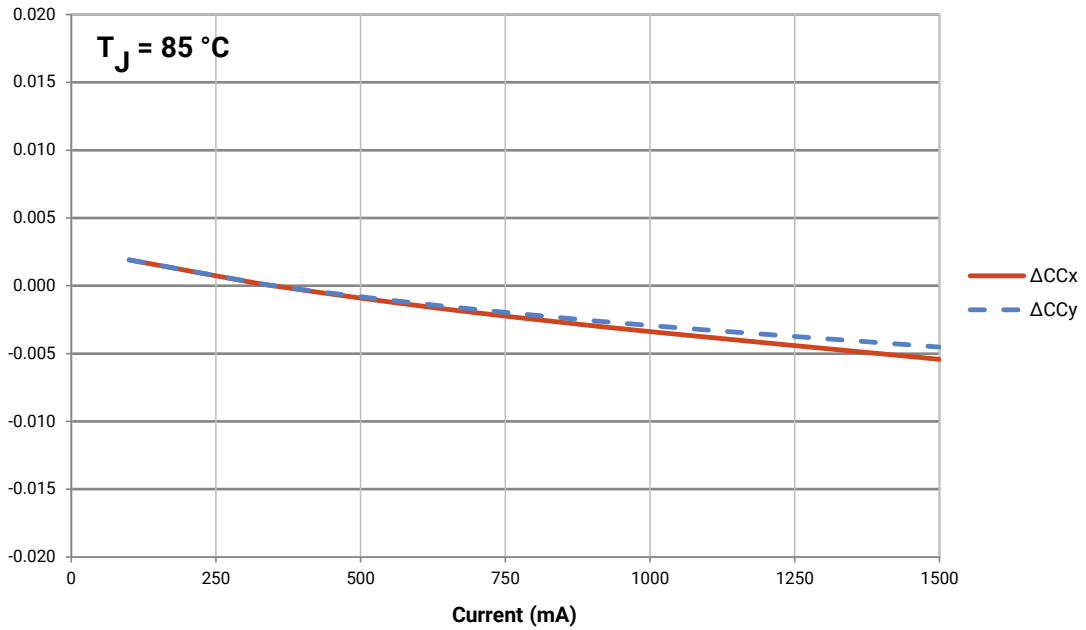

RELATIVE CHROMATICITY VS. TEMPERATURE - WARM WHITE

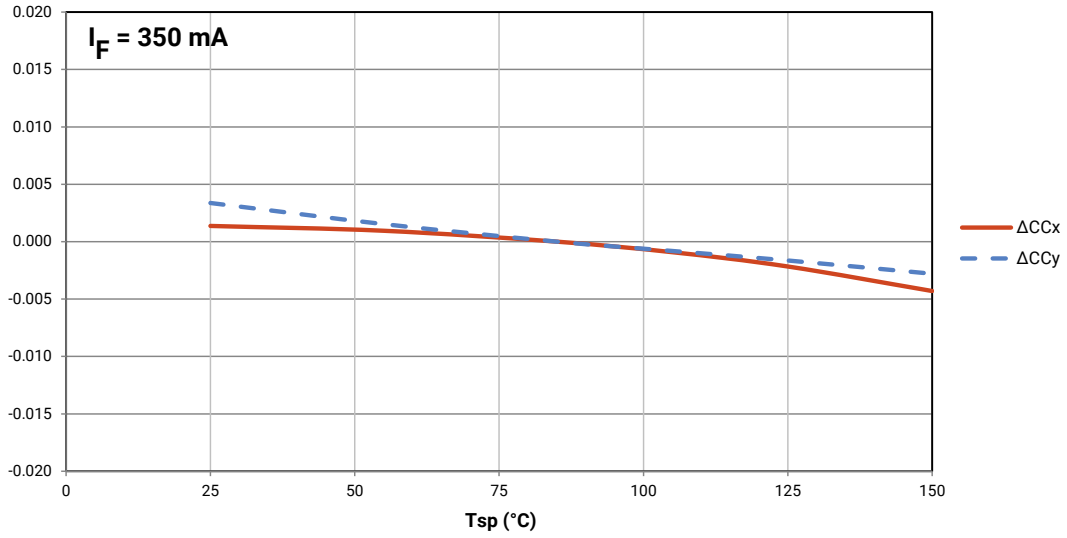

TYPICAL SPATIAL DISTRIBUTION - WHITE

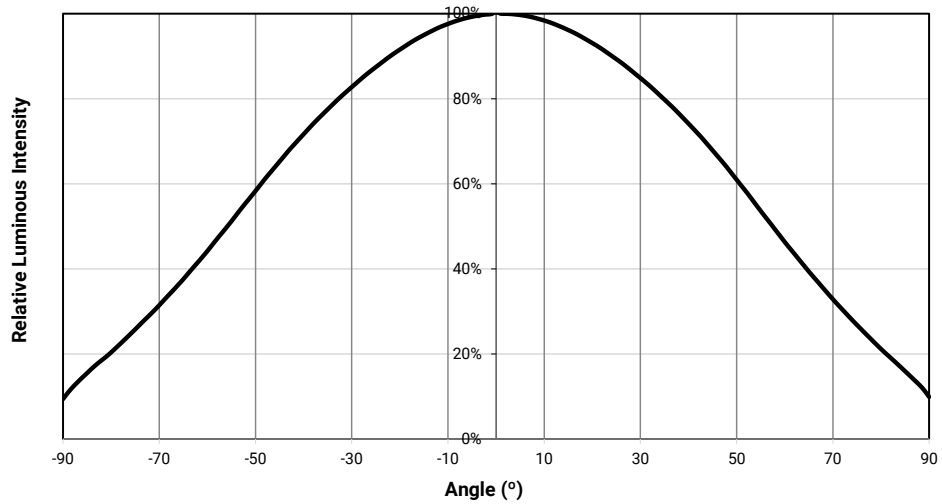

TYPICAL SPATIAL DISTRIBUTION - ROYAL BLUE

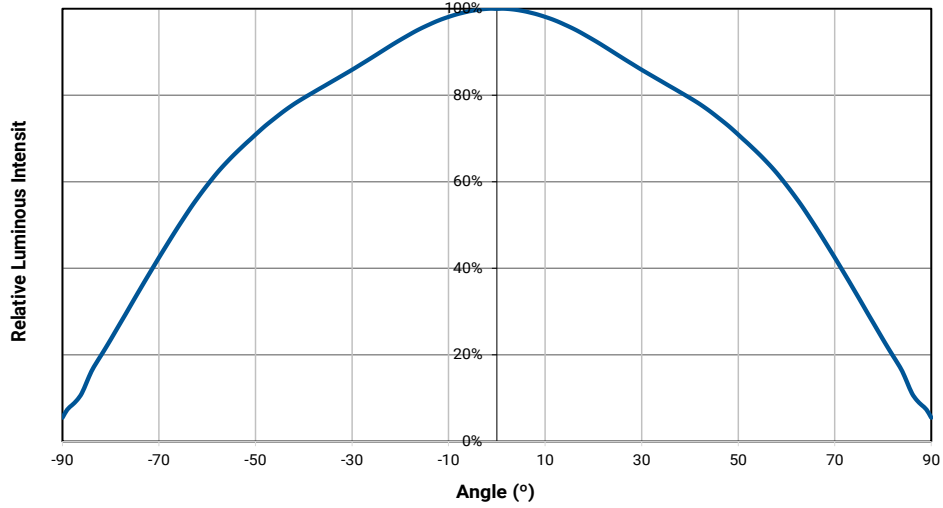

THERMAL DESIGN - WHITE

The maximum forward current is determined by the thermal resistance between the LED junction and ambient. It is crucial for the end product to be designed in a manner that minimizes the thermal resistance from the solder point to ambient in order to optimize lamp life and optical characteristics.

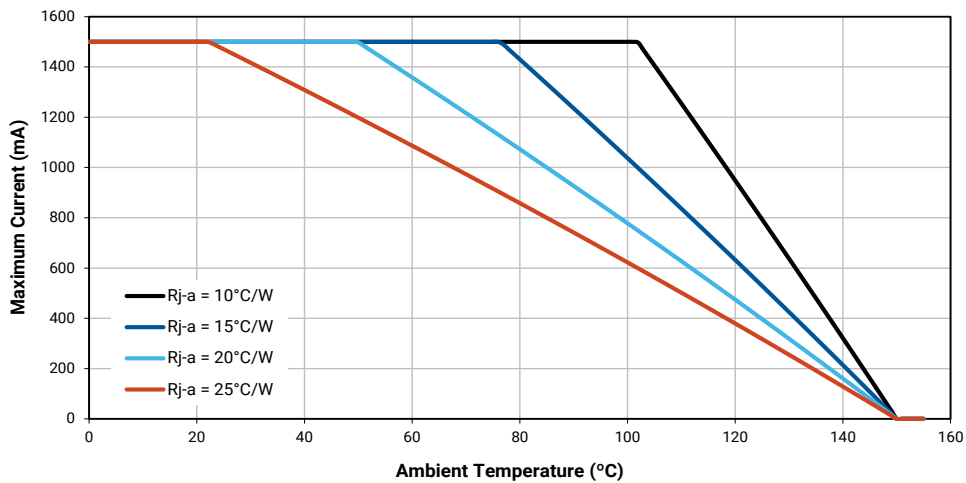

### THERMAL DESIGN - ROYAL BLUE

The maximum forward current is determined by the thermal resistance between the LED junction and ambient. It is crucial for the end product to be designed in a manner that minimizes the thermal resistance from the solder point to ambient in order to optimize lamp life and optical characteristics.

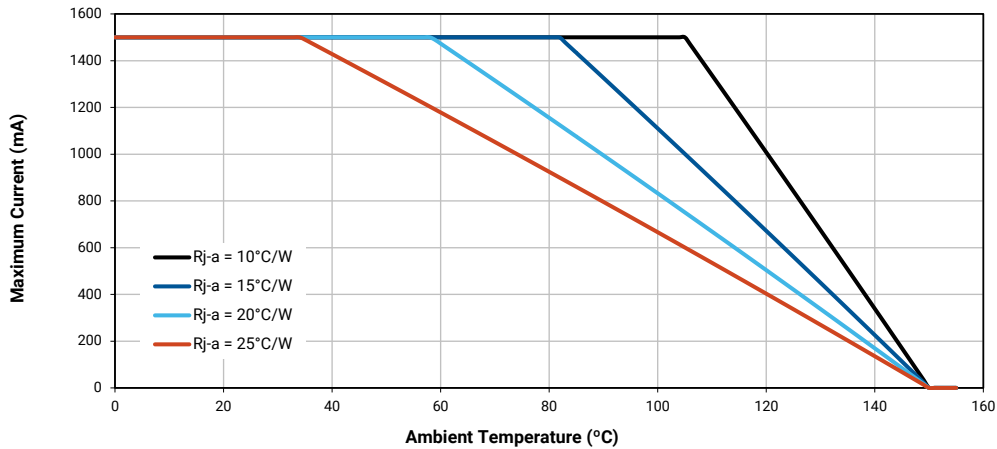

### PERFORMANCE GROUPS - LUMINOUS FLUX (T<sub>J</sub> = 85 °C)

XLamp XT-E White LEDs are tested for luminous flux and placed into one of the following luminous-flux groups.

Group Code	Minimum Luminous Flux (lm) @ 350 mA	Maximum Luminous Flux (lm) @ 350 mA
P3	73.9	80.6
P4	80.6	87.4
Q2	87.4	93.9
Q3	93.9	100
Q4	100	107
Q5	107	114
R2	114	122
R3	122	130
R4	130	139
R5	139	148
S2	148	156
S3	156	164
S4	164	172
S5	172	180
S6	180	188
S7	188	196
S8	196	204

## PERFORMANCE GROUPS - RADIANT FLUX ( $T_J = 85\text{ }^\circ\text{C}$ )

XLamp XT-E Royal Blue LEDs are tested for radiant flux and placed into one of the following bins.

Group Code	Minimum Radiant Flux (mW)	Maximum Radiant Flux (mW)	Calculated PPF ( $\mu\text{mol/s}$ )	
			Minimum	Maximum
34 (N)	550	575	2.08	2.18
35 (P)	575	600	2.18	2.27
36 (Q)	600	625	2.27	2.37
37 (R)	625	650	2.37	2.46
38 (S)	650	675	2.46	2.56
39 (T)	675	700	2.56	2.65

### Note

- Calculated PPF values are for reference only.

## PERFORMANCE GROUPS - DOMINANT WAVELENGTH ( $T_J = 85\text{ }^\circ\text{C}$ )

XLamp XT-E Royal Blue LEDs are tested for dominant wavelength (DWL) and placed into one of the regions defined by the following bounding coordinates.

Group Code	Minimum Dominant Wavelength (nm)	Maximum Dominant Wavelength (nm)	Typical Peak Wavelength (nm)
D36	450.0	452.5	446.0
D37	452.5	455.0	448.5
D46	455.0	457.5	451.0
D47	457.5	460.0	453.5
D56	460.0	462.5	456.0
D57	462.5	465.0	458.5

### Note

- Typical peak wavelength values are calculated and for reference only.

## PERFORMANCE GROUPS - FORWARD VOLTAGE ( $T_J = 85\text{ }^\circ\text{C}$ )

XLamp XT-E LEDs are tested for forward voltage and placed into one of the following voltage bins.

Group Code	Minimum Forward Voltage (V)	Maximum Forward Voltage (V)
1	2.50	2.85
E	2.50	2.75
F	2.75	3.00
G	3.00	3.25
H	3.25	3.50

PERFORMANCE GROUPS - CHROMATICITY

Region	x	y	Region	x	y	Region	x	y	Region	x	y
0A	0.2950	0.2970	0B	0.2920	0.3060	0C	0.2984	0.3133	0D	0.2984	0.3133
	0.2920	0.3060		0.2895	0.3135		0.2962	0.3220		0.3048	0.3207
	0.2984	0.3133		0.2962	0.3220		0.3028	0.3304		0.3068	0.3113
	0.3009	0.3042		0.2984	0.3133		0.3048	0.3207		0.3009	0.3042
0R	0.2980	0.2880	0S	0.2895	0.3135	0T	0.2962	0.3220	0U	0.3037	0.2937
	0.2950	0.2970		0.2870	0.3210		0.2937	0.3312		0.3009	0.3042
	0.3009	0.3042		0.2937	0.3312		0.3005	0.3415		0.3068	0.3113
	0.3037	0.2937		0.2962	0.3220		0.3028	0.3304		0.3093	0.2993
1A	0.3048	0.3207	1B	0.3028	0.3304	1C	0.3115	0.3391	1D	0.3130	0.3290
	0.3130	0.3290		0.3115	0.3391		0.3205	0.3481		0.3213	0.3373
	0.3144	0.3186		0.3130	0.3290		0.3213	0.3373		0.3221	0.3261
	0.3068	0.3113		0.3048	0.3207		0.3130	0.3290		0.3144	0.3186
1R	0.3068	0.3113	1S	0.3005	0.3415	1T	0.3099	0.3509	1U	0.3144	0.3186
	0.3144	0.3186		0.3099	0.3509		0.3196	0.3602		0.3221	0.3261
	0.3161	0.3059		0.3115	0.3391		0.3205	0.3481		0.3231	0.3120
	0.3093	0.2993		0.3028	0.3304		0.3115	0.3391		0.3161	0.3059
2A	0.3215	0.3350	2B	0.3207	0.3462	2C	0.3290	0.3538	2D	0.3290	0.3417
	0.3290	0.3417		0.3290	0.3538		0.3376	0.3616		0.3371	0.3490
	0.3290	0.3300		0.3290	0.3417		0.3371	0.3490		0.3366	0.3369
	0.3222	0.3243		0.3215	0.3350		0.3290	0.3417		0.3290	0.3300
2R	0.3222	0.3243	2S	0.3196	0.3602	2T	0.3290	0.3690	2U	0.3290	0.3300
	0.3290	0.3300		0.3290	0.3690		0.3381	0.3762		0.3366	0.3369
	0.3290	0.3180		0.3290	0.3538		0.3376	0.3616		0.3361	0.3245
	0.3231	0.3120		0.3207	0.3462		0.3290	0.3538		0.3290	0.3180
3A	0.3371	0.3490	3B	0.3376	0.3616	3C	0.3463	0.3687	3D	0.3451	0.3554
	0.3451	0.3554		0.3463	0.3687		0.3551	0.3760		0.3533	0.3620
	0.3440	0.3427		0.3451	0.3554		0.3533	0.3620		0.3515	0.3487
	0.3366	0.3369		0.3371	0.3490		0.3451	0.3554		0.3440	0.3427
3R	0.3366	0.3369	3S	0.3381	0.3762						
	0.3440	0.3428		0.3480	0.3840						
	0.3429	0.3307		0.3463	0.3687						
	0.3361	0.3245		0.3376	0.3616						
4A	0.3530	0.3597	4B	0.3548	0.3736	4C	0.3641	0.3804	4D	0.3615	0.3659
	0.3615	0.3659		0.3641	0.3804		0.3736	0.3874		0.3702	0.3722
	0.3590	0.3521		0.3615	0.3659		0.3702	0.3722		0.3670	0.3578
	0.3512	0.3465		0.3530	0.3597		0.3615	0.3659		0.3590	0.3521
4R	0.3512	0.3465	4S	0.3571	0.3907	4T	0.3668	0.3957	4U	0.3590	0.3521
	0.3590	0.3521		0.3668	0.3957		0.3771	0.4034		0.3670	0.3578
	0.3567	0.3389		0.3641	0.3804		0.3736	0.3874		0.3640	0.3440
	0.3495	0.3339		0.3548	0.3736		0.3641	0.3804		0.3567	0.3389

PERFORMANCE GROUPS - CHROMATICITY (CONTINUED)

Region	x	y	Region	x	y	Region	x	y	Region	x	y
5A1	0.3670	0.3578	5A2	0.3686	0.3649	5A3	0.3744	0.3685	5A4	0.3726	0.3612
	0.3686	0.3649		0.3702	0.3722		0.3763	0.3760		0.3744	0.3685
	0.3744	0.3685		0.3763	0.3760		0.3825	0.3798		0.3804	0.3721
	0.3726	0.3612		0.3744	0.3685		0.3804	0.3721		0.3783	0.3646
5B1	0.3702	0.3722	5B2	0.3719	0.3797	5B3	0.3782	0.3837	5B4	0.3763	0.3760
	0.3719	0.3797		0.3736	0.3874		0.3802	0.3916		0.3782	0.3837
	0.3782	0.3837		0.3802	0.3916		0.3869	0.3958		0.3847	0.3877
	0.3763	0.3760		0.3782	0.3837		0.3847	0.3877		0.3825	0.3798
5C1	0.3825	0.3798	5C2	0.3847	0.3877	5C3	0.3912	0.3917	5C4	0.3887	0.3836
	0.3847	0.3877		0.3869	0.3958		0.3937	0.4001		0.3912	0.3917
	0.3912	0.3917		0.3937	0.4001		0.4006	0.4044		0.3978	0.3958
	0.3887	0.3836		0.3912	0.3917		0.3978	0.3958		0.3950	0.3875
5D1	0.3783	0.3646	5D2	0.3804	0.3721	5D3	0.3863	0.3758	5D4	0.3840	0.3681
	0.3804	0.3721		0.3825	0.3798		0.3887	0.3836		0.3863	0.3758
	0.3863	0.3758		0.3887	0.3836		0.3950	0.3875		0.3924	0.3794
	0.3840	0.3681		0.3863	0.3758		0.3924	0.3794		0.3898	0.3716
5R	0.3670	0.3578	5S	0.3771	0.4034						
	0.3783	0.3646		0.3916	0.4127						
	0.3743	0.3502		0.3869	0.3958						
	0.3640	0.3440		0.3736	0.3874						
6A1	0.3889	0.3690	6A2	0.3915	0.3768	6A3	0.3981	0.3800	6A4	0.4080	0.3916
	0.3915	0.3768		0.3941	0.3848		0.4010	0.3882		0.3981	0.3800
	0.3981	0.3800		0.4010	0.3882		0.4080	0.3916		0.4048	0.3832
	0.3953	0.3720		0.3981	0.3800		0.4048	0.3832		0.4017	0.3751
6B1	0.3941	0.3848	6B2	0.3968	0.3930	6B3	0.4040	0.3966	6B4	0.4010	0.3882
	0.3968	0.3930		0.3996	0.4015		0.4071	0.4052		0.4040	0.3966
	0.4040	0.3966		0.4071	0.4052		0.4146	0.4089		0.4113	0.4001
	0.4010	0.3882		0.4040	0.3966		0.4113	0.4001		0.4080	0.3916
6C1	0.4080	0.3916	6C2	0.4113	0.4001	6C3	0.4186	0.4037	6C4	0.4150	0.3950
	0.4113	0.4001		0.4146	0.4089		0.4222	0.4127		0.4186	0.4037
	0.4186	0.4037		0.4222	0.4127		0.4299	0.4165		0.4259	0.4073
	0.4150	0.3950		0.4186	0.4037		0.4259	0.4073		0.4221	0.3984
6D1	0.4017	0.3751	6D2	0.4048	0.3832	6D3	0.4116	0.3865	6D4	0.4082	0.3782
	0.4048	0.3832		0.4080	0.3916		0.4150	0.3950		0.4116	0.3865
	0.4116	0.3865		0.4150	0.3950		0.4221	0.3984		0.4183	0.3898
	0.4082	0.3782		0.4116	0.3865		0.4183	0.3898		0.4147	0.3814
7A1	0.4147	0.3814	7A2	0.4183	0.3898	7A3	0.4242	0.3919	7A4	0.4203	0.3833
	0.4183	0.3898		0.4221	0.3984		0.4281	0.4006		0.4242	0.3919
	0.4242	0.3919		0.4281	0.4006		0.4342	0.4028		0.4300	0.3939
	0.4203	0.3833		0.4242	0.3919		0.4300	0.3939		0.4259	0.3853

PERFORMANCE GROUPS - CHROMATICITY (CONTINUED)

Region	x	y	Region	x	y	Region	x	y	Region	x	y
7B1	0.4221	0.3984	7B2	0.4259	0.4073	7B3	0.4322	0.4096	7B4	0.4281	0.4006
	0.4259	0.4073		0.4299	0.4165		0.4364	0.4188		0.4322	0.4096
	0.4322	0.4096		0.4364	0.4188		0.4430	0.4212		0.4385	0.4119
	0.4281	0.4006		0.4322	0.4096		0.4385	0.4119		0.4342	0.4028
7C1	0.4342	0.4028	7C2	0.4385	0.4119	7C3	0.4449	0.4141	7C4	0.4403	0.4049
	0.4385	0.4119		0.4430	0.4212		0.4496	0.4236		0.4449	0.4141
	0.4449	0.4141		0.4496	0.4236		0.4562	0.4260		0.4513	0.4164
	0.4403	0.4049		0.4449	0.4141		0.4513	0.4164		0.4465	0.4071
7D1	0.4259	0.3853	7D2	0.4300	0.3939	7D3	0.4359	0.3960	7D4	0.4316	0.3873
	0.4300	0.3939		0.4342	0.4028		0.4403	0.4049		0.4359	0.3960
	0.4359	0.3960		0.4403	0.4049		0.4465	0.4071		0.4418	0.3981
	0.4316	0.3873		0.4359	0.3960		0.4418	0.3981		0.4373	0.3893
8A1	0.4373	0.3893	8A2	0.4418	0.3981	8A3	0.4475	0.3994	8A4	0.4428	0.3906
	0.4418	0.3981		0.4465	0.4071		0.4523	0.4085		0.4475	0.3994
	0.4475	0.3994		0.4523	0.4085		0.4582	0.4099		0.4532	0.4008
	0.4428	0.3906		0.4475	0.3994		0.4532	0.4008		0.4483	0.3919
8B1	0.4465	0.4071	8B2	0.4513	0.4164	8B3	0.4573	0.4178	8B4	0.4523	0.4085
	0.4513	0.4164		0.4562	0.4260		0.4624	0.4274		0.4573	0.4178
	0.4573	0.4178		0.4624	0.4274		0.4687	0.4289		0.4634	0.4193
	0.4523	0.4085		0.4573	0.4178		0.4634	0.4193		0.4582	0.4099
8C1	0.4582	0.4158	8C2	0.4634	0.4193	8C3	0.4695	0.4207	8C4	0.4641	0.4112
	0.4634	0.4252		0.4687	0.4289		0.4750	0.4304		0.4695	0.4207
	0.4695	0.4250		0.4750	0.4304		0.4813	0.4319		0.4756	0.4221
	0.4641	0.4156		0.4695	0.4207		0.4756	0.4221		0.4700	0.4126
8D1	0.4483	0.3919	8D2	0.4532	0.4008	8D3	0.4589	0.4021	8D4	0.4538	0.3931
	0.4532	0.4008		0.4582	0.4099		0.4641	0.4112		0.4589	0.4021
	0.4589	0.4021		0.4641	0.4112		0.4700	0.4126		0.4646	0.4034
	0.4538	0.3931		0.4589	0.4021		0.4646	0.4034		0.4593	0.3944
AA1	0.4822	0.3973	AA2	0.4884	0.4067	AA3	0.4942	0.4066	AA4	0.4879	0.3972
	0.4884	0.4067		0.4946	0.4162		0.5006	0.4160		0.4942	0.4066
	0.4942	0.4066		0.5006	0.4160		0.5066	0.4158		0.5001	0.4064
	0.4879	0.3972		0.4942	0.4066		0.5001	0.4064		0.4936	0.3970
AB1	0.4946	0.4162	AB2	0.5008	0.4256	AB3	0.5069	0.4254	AB4	0.5006	0.4160
	0.5008	0.4256		0.5070	0.4350		0.5133	0.4348		0.5069	0.4254
	0.5069	0.4254		0.5133	0.4348		0.5196	0.4346		0.5131	0.4252
	0.5006	0.4160		0.5069	0.4254		0.5131	0.4252		0.5066	0.4158
AC1	0.5066	0.4158	AC2	0.5131	0.4252	AC3	0.5192	0.4250	AC4	0.5126	0.4156
	0.5131	0.4252		0.5196	0.4346		0.5258	0.4343		0.5192	0.4250
	0.5192	0.4250		0.5258	0.4343		0.5321	0.4341		0.5253	0.4248
	0.5126	0.4156		0.5192	0.4250		0.5253	0.4248		0.5186	0.4154

**PERFORMANCE GROUPS - CHROMATICITY (CONTINUED)**

Region	x	y	Region	x	y	Region	x	y	Region	x	y
AD1	0.4936	0.3970	AD2	0.5001	0.4064	AD3	0.5059	0.4062	AD4	0.4993	0.3969
	0.5001	0.4064		0.5066	0.4158		0.5126	0.4156		0.5059	0.4062
	0.5059	0.4062		0.5126	0.4156		0.5186	0.4154		0.5118	0.4061
	0.4993	0.3969		0.5059	0.4062		0.5118	0.4061		0.5050	0.3967

XLamp High-Efficacy XT-E 3-step and 5-step LEDs are tested for chromaticity and placed into one of the regions defined by the following bounding coordinates.

EasyWhite Color Temperatures – 3-Step Ellipse						
Bin Code	CCT	Center Point		Major Axis	Minor Axis	Rotation Angle (°)
		x	y	a	b	
1G	6500 K	0.3123	0.3282	0.00666	0.00330	61.0
2G	5700 K	0.3287	0.3417	0.00738	0.00360	72.0
3G	5000 K	0.3447	0.3553	0.00840	0.00312	65.0
4G	4500 K	0.3611	0.3658	0.00852	0.00330	61.5
5G	4000 K	0.3818	0.3797	0.00939	0.00402	53.7
6G	3500 K	0.4073	0.3917	0.00927	0.00414	54.0
7G	3000 K	0.4338	0.4030	0.00834	0.00408	53.2
8G	2700 K	0.4577	0.4099	0.00834	0.00420	48.5
AG	2200 K	0.5066	0.4158	0.00980	0.00480	45.5

EasyWhite Color Temperatures – 5-Step Ellipse						
Bin Code	CCT	Center Point		Major Axis	Minor Axis	Rotation Angle (°)
		x	y	a	b	
1E	6500 K	0.3123	0.3282	0.01110	0.00550	61.0
2E	5700 K	0.3287	0.3417	0.01230	0.00600	72.0
3E	5000 K	0.3447	0.3553	0.01400	0.00520	65.0
4E	4500 K	0.3611	0.3658	0.01420	0.00550	61.5
5E	4000 K	0.3818	0.3797	0.01565	0.00670	53.7
6E	3500 K	0.4073	0.3917	0.01545	0.00690	54.0
7E	3000 K	0.4338	0.4030	0.01390	0.00680	53.2
8E	2700 K	0.4577	0.4099	0.01390	0.00700	48.5
AE	2200 K	0.5066	0.4158	0.01630	0.00800	45.5

COOL WHITE KITS PLOTTED ON ANSI STANDARD CHROMATICITY REGIONS

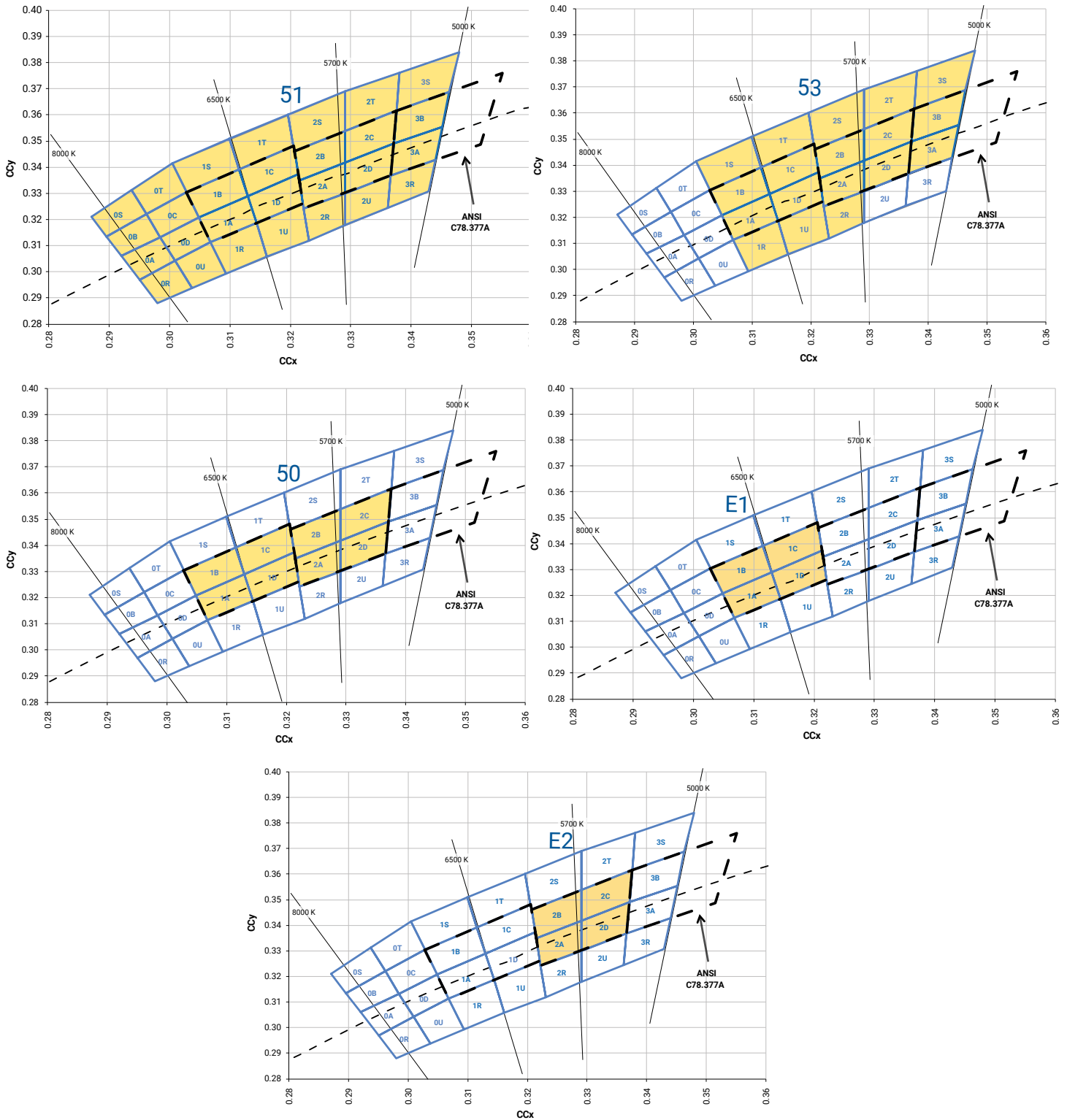

WHITE KITS PLOTTED ON ANSI STANDARD CHROMATICITY REGIONS

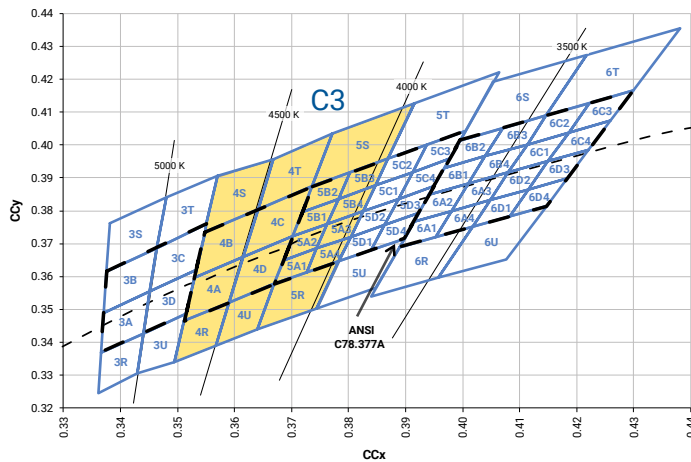
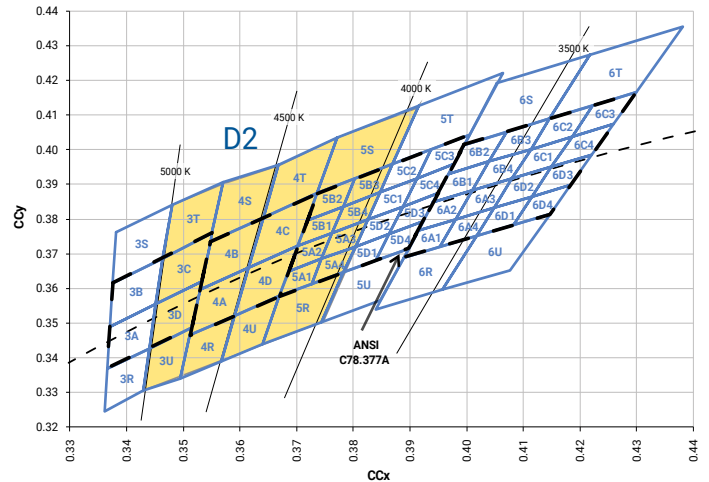
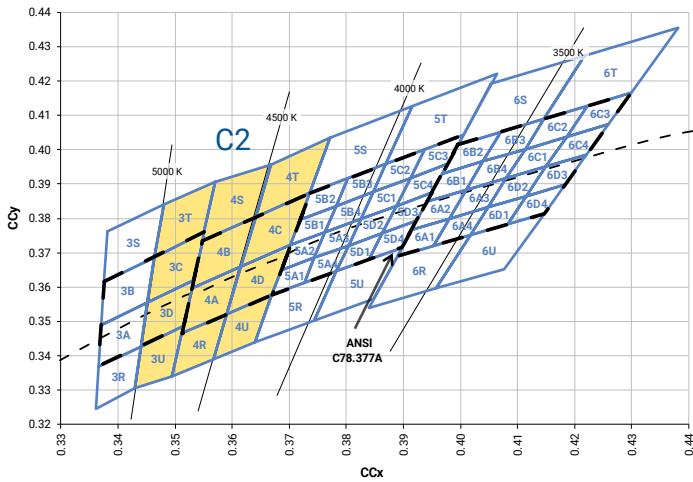
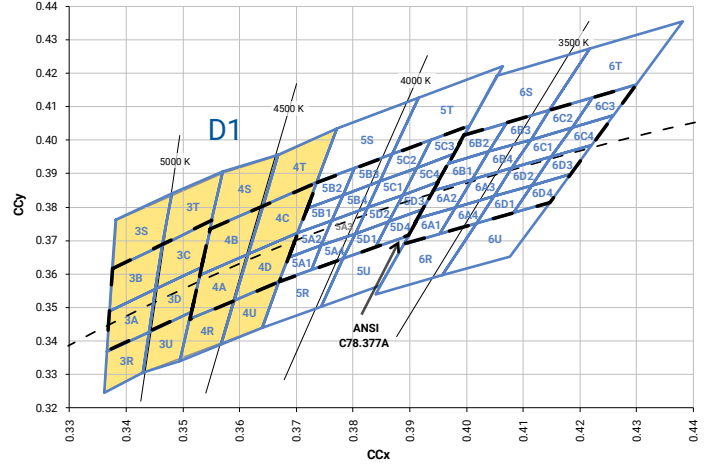
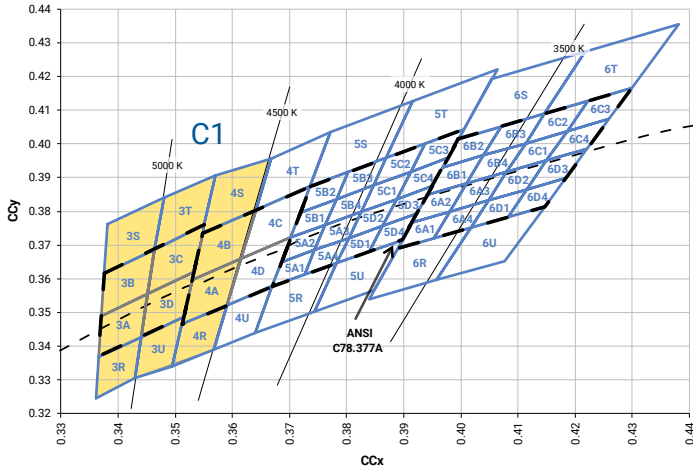

WARM AND NEUTRAL WHITE KITS PLOTTED ON ANSI STANDARD CHROMATICITY REGIONS

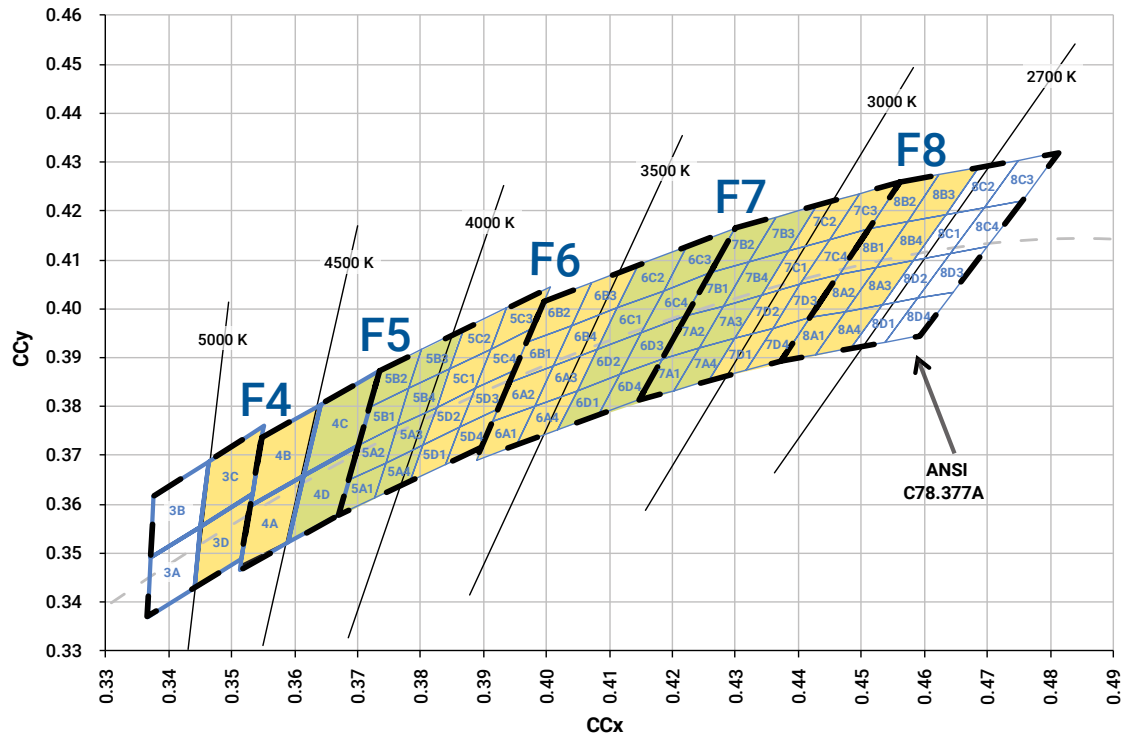
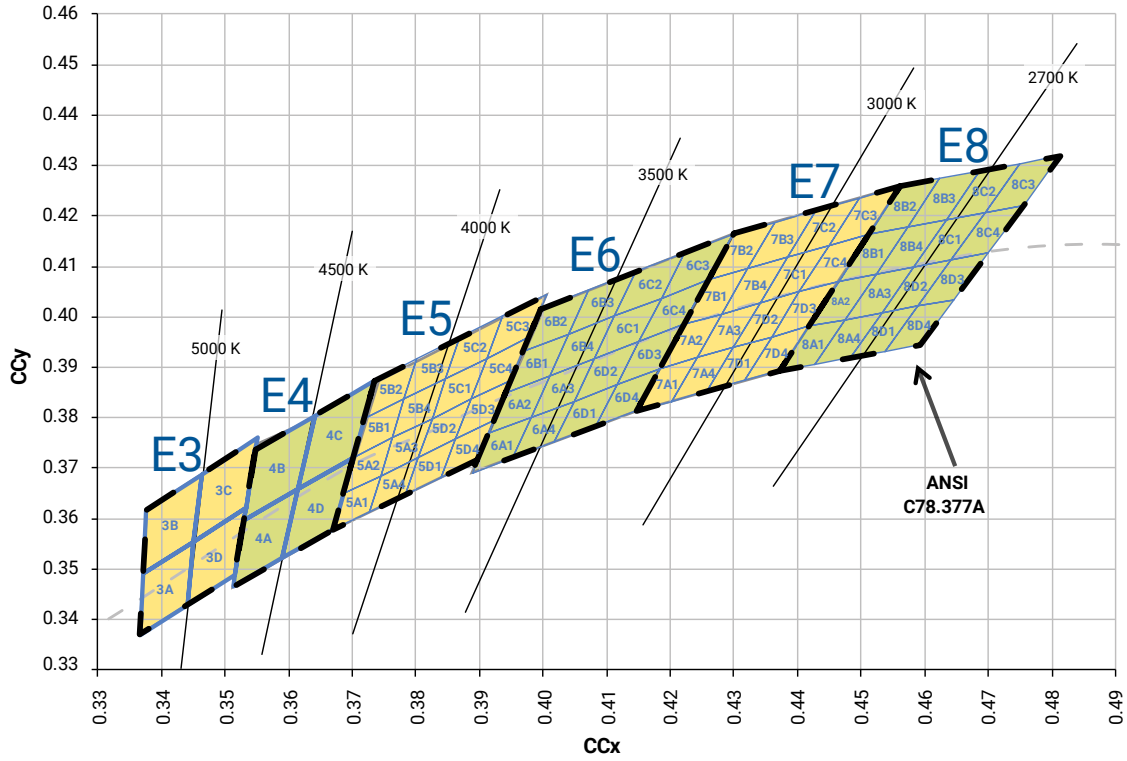

2200 K CCT WHITE KIT PLOTTED ON ANSI STANDARD CHROMATICITY REGIONS

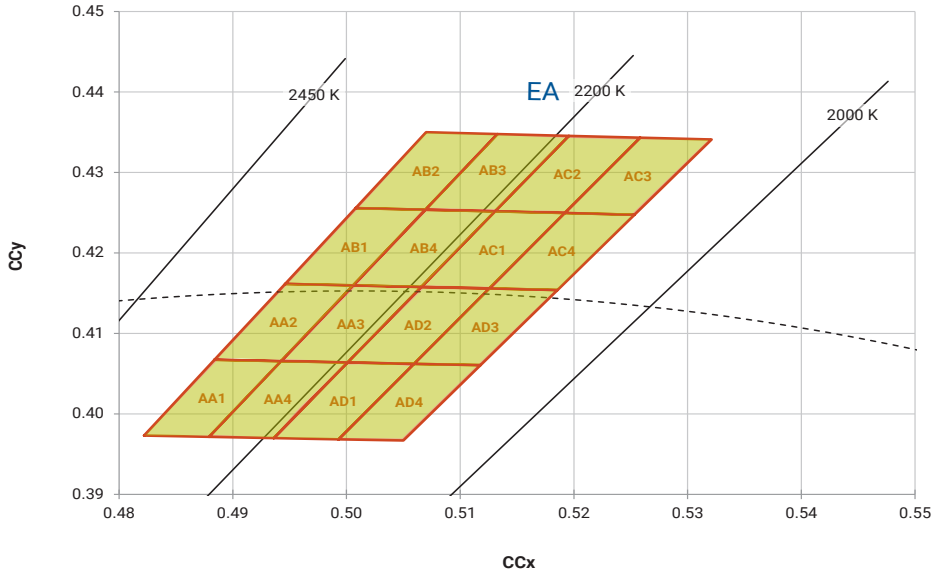

EASYWHITE® BINS PLOTTED ON THE 1931 CIE COLOR SPACE ( $T_j = 85^\circ\text{C}$ )

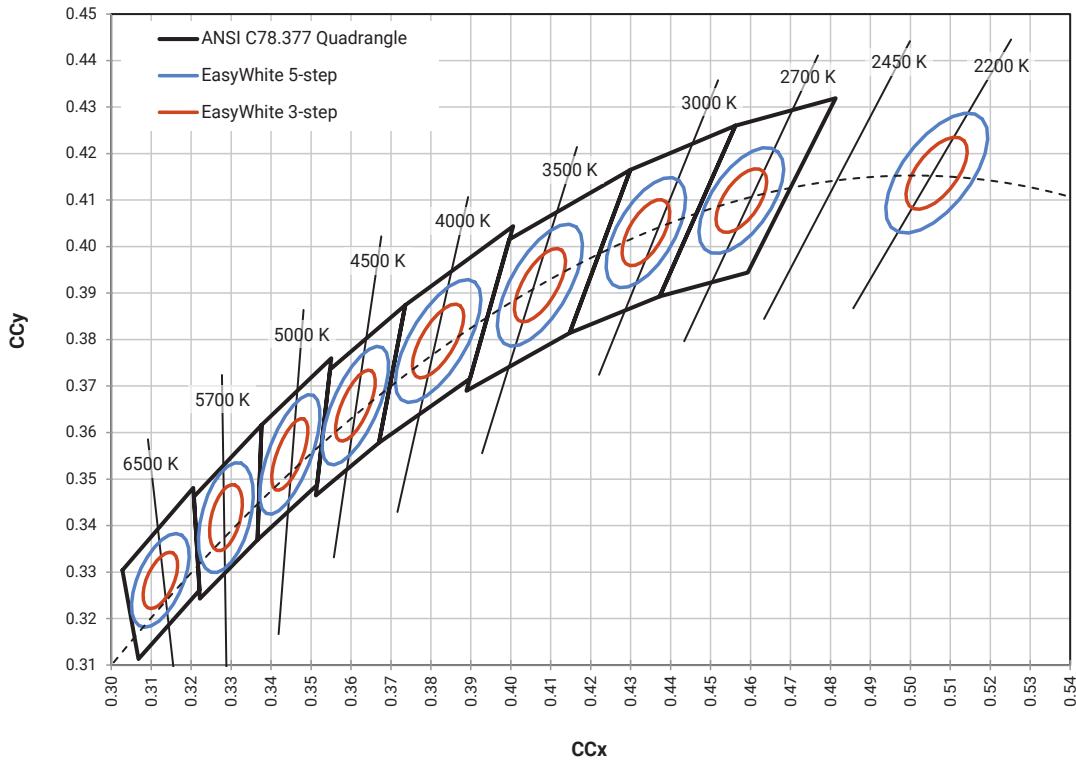

## STANDARD CHROMATICITY KITS

The following table provides the chromaticity bins associated with chromaticity kits for XT-E White LEDs.

Color	CCT	Kit	Chromaticity Bins
Cool White	6200 K	51	0A, 0B, 0C, 0D, 0R, 0S, 0T, 0U, 1A, 1B, 1C, 1D, 1R, 1S, 1T, 1U, 2A, 2B, 2C, 2D, 2R, 2S, 2T, 2U, 3A, 3B, 3R, 3S
	6000 K	53	1A, 1B, 1C, 1D, 1R, 1S, 1T, 1U, 2A, 2B, 2C, 2D, 2R, 2S, 2T, 3A, 3B, 3S
	6200 K	50	1A, 1B, 1C, 1D, 2A, 2B, 2C, 2D
	6500 K	E1	1A, 1B, 1C, 1D
	5700 K	E2	2A, 2B, 2C, 2D
Neutral White	5000 K	E3	3A, 3B, 3C, 3D
	5000 K	C1	3A, 3B, 3C, 3D, 3R, 3S, 3T, 3U, 4A, 4B, 4R, 4S
	4750 K	F4	3C, 3D, 4A, 4B
	4750 K	D1	3A, 3B, 3C, 3D, 3R, 3S, 3T, 3U, 4A, 4B, 4C, 4D, 4R, 4S, 4T, 4U
	4500 K	E4	4A, 4B, 4C, 4D
	4500 K	D2	3C, 3D, 3T, 3U, 4A, 4B, 4C, 4D, 4R, 4S, 4T, 4U, 5A1, 5A2, 5A3, 5A4, 5B1, 5B2, 5B3, 5B4, 5R, 5S
	4500 K	C2	3C, 3D, 3T, 3U, 4A, 4B, 4C, 4D, 4R, 4S, 4T, 4U
	4300 K	C3	4A, 4B, 4C, 4D, 4R, 4S, 4T, 4U, 5A1, 5A2, 5A3, 5A4, 5B1, 5B2, 5B3, 5B4, 5R, 5S
	4250 K	F5	4C, 4D, 5A1, 5A2, 5A3, 5A4, 5B1, 5B2, 5B3, 5B4
4000 K	E5	5A1, 5A2, 5A3, 5A4, 5B1, 5B2, 5B3, 5B4, 5C1, 5C2, 5C3, 5C4, 5D1, 5D2, 5D3, 5D4	
Warm White	3750 K	F6	5C1, 5C2, 5C3, 5C4, 5D1, 5D2, 5D3, 5D4, 6A1, 6A2, 6A3, 6A4, 6B1, 6B2, 6B3, 6B4
	3500 K	E6	6A1, 6A2, 6A3, 6A4, 6B1, 6B2, 6B3, 6B4, 6C1, 6C2, 6C3, 6C4, 6D1, 6D2, 6D3, 6D4
	3250 K	F7	6C1, 6C2, 6C3, 6C4, 6D1, 6D2, 6D3, 6D4, 7A1, 7A2, 7A3, 7A4, 7B1, 7B2, 7B3, 7B4
	3000 K	E7	7A1, 7A2, 7A3, 7A4, 7B1, 7B2, 7B3, 7B4, 7C1, 7C2, 7C3, 7C4, 7D1, 7D2, 7D3, 7D4
	2850 K	F8	7C1, 7C2, 7C3, 7C4, 7D1, 7D2, 7D3, 7D4, 8A1, 8A2, 8A3, 8A4, 8B1, 8B2, 8B3, 8B4
	2700 K	E8	8A1, 8A2, 8A3, 8A4, 8B1, 8B2, 8B3, 8B4, 8C1, 8C2, 8C3, 8C4, 8D1, 8D2, 8D3, 8D4
	2200 K	EA	AA1, AA2, AA3, AA4, AB1, AB2, AB3, AB4, AC1, AC2, AC3, AC4, AD1, AD2, AD3, AD4

## BIN AND ORDER CODE FORMATS

Bin codes and order codes for XT-E LEDs are configured in the following manner:

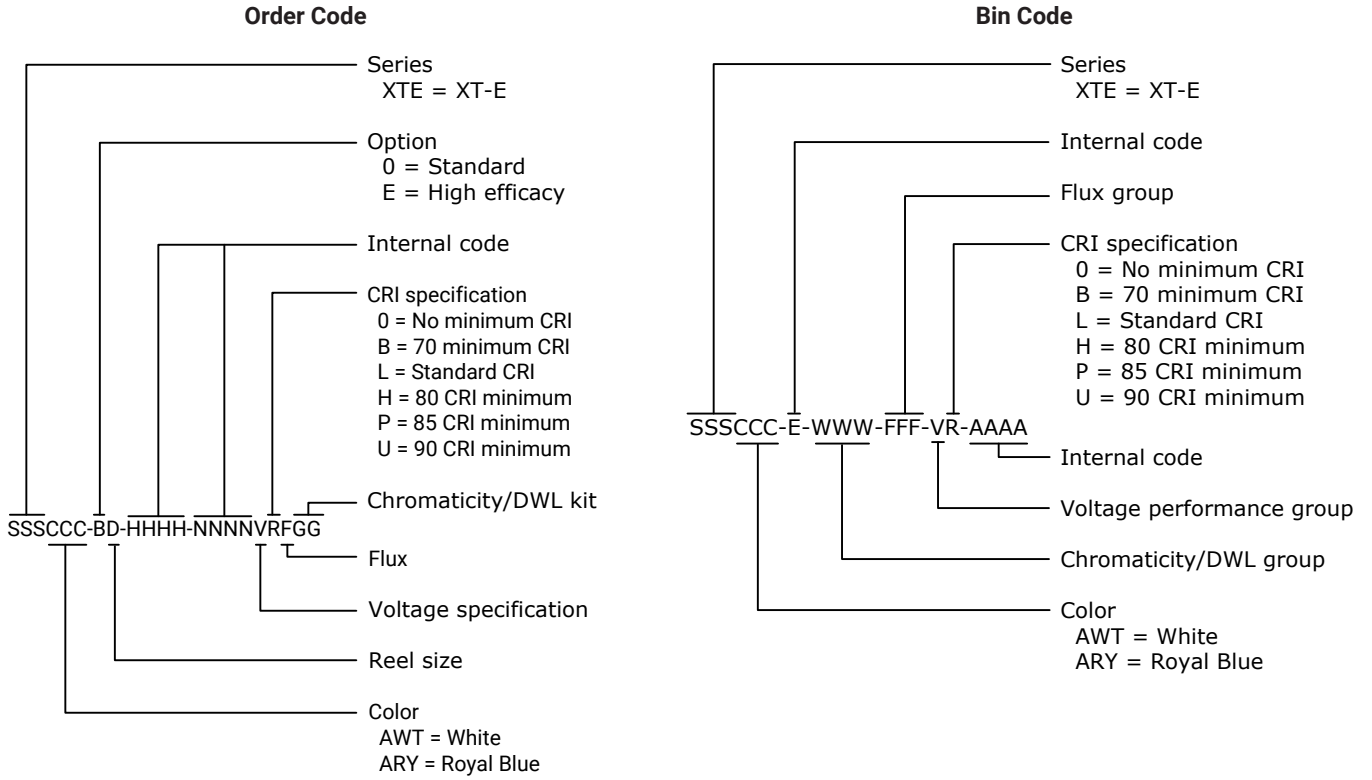

## REFLOW SOLDERING CHARACTERISTICS

In testing, Cree LED has found XLamp XT-E LEDs to be compatible with JEDEC J-STD-020C, using the parameters listed below. As a general guideline, Cree LED recommends that users follow the recommended soldering profile provided by the manufacturer of the solder paste used, and therefore it is the lamp or luminaire manufacturer’s responsibility to determine applicable soldering requirements.

Note that this general guideline may not apply to all PCB designs and configurations of reflow soldering equipment.

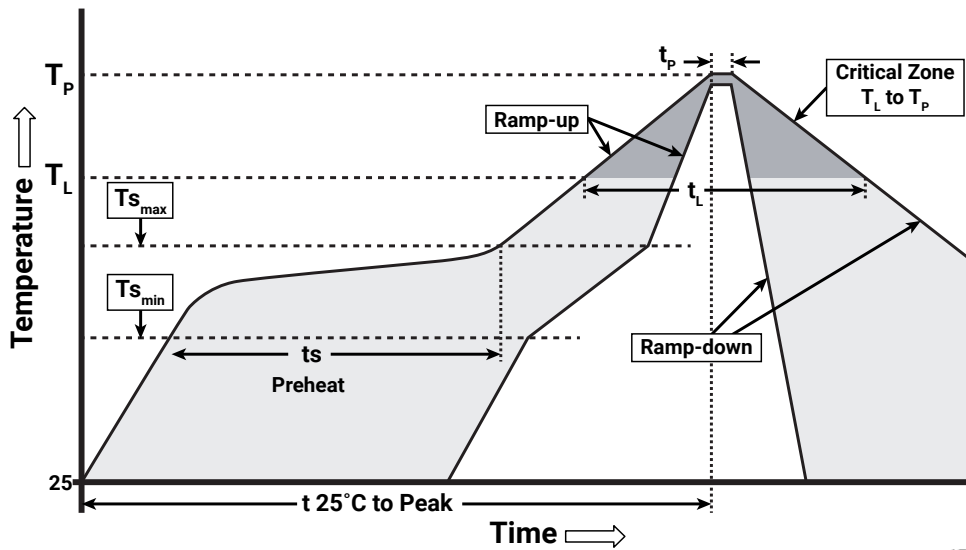

IPC/JEDEC J-STD-020C

Profile Feature	Lead-Free Solder
Average Ramp-Up Rate ( $T_{s_{max}}$ to $T_p$ )	1.2 °C/second
Preheat: Temperature Min ( $T_{s_{min}}$ )	120 °C
Preheat: Temperature Max ( $T_{s_{max}}$ )	170 °C
Preheat: Time ( $T_{s_{min}}$ to $T_{s_{max}}$ )	65-150 seconds
Time Maintained Above: Temperature ( $T_L$ )	217 °C
Time Maintained Above: Time ( $t_L$ )	45-90 seconds
Peak/Classification Temperature ( $T_p$ )	235 - 245 °C
Time Within 5 °C of Actual Peak Temperature ( $t_p$ )	20-40 seconds
Ramp-Down Rate	1 - 6 °C/second
Time 25 °C to Peak Temperature	4 minutes max.

Note: All temperatures refer to the topside of the package, measured on the package body surface.

## NOTES

---

### Measurements

The luminous flux, radiant power, chromaticity, forward voltage and CRI measurements in this document are binning specifications only and solely represent product measurements as of the date of shipment. These measurements will change over time based on a number of factors that are not within Cree LED's control and are not intended or provided as operational specifications for the products. Calculated values are provided for informational purposes only and are not intended or provided as specifications.

### Pre-Release Qualification Testing

Please read the [LED Reliability Overview](#) for details of the qualification process Cree LED applies to ensure long-term reliability for XLamp LEDs and details of Cree LED's pre-release qualification testing for XLamp LEDs. Cree LED did not perform Room Temperature Operating Life (RTOL) testing on the XT-E LED.

### Lumen Maintenance

Cree LED now uses standardized IES LM-80-08 and TM-21-11 methods for collecting long-term data and extrapolating LED lumen maintenance. For information on the specific LM-80 data sets available for this LED, refer to the public [LM-80 results document](#).

Please read the [Long-Term Lumen Maintenance application note](#) for more details on Cree LED's lumen maintenance testing and forecasting. Please read the [Thermal Management application note](#) for details on how thermal design, ambient temperature, and drive current affect the LED junction temperature.

### Moisture Sensitivity

Cree LED recommends keeping XLamp LEDs in the provided, resealable moisture-barrier packaging (MBP) until immediately prior to soldering. Unopened MBPs that contain XLamp LEDs do not need special storage for moisture sensitivity.

Once the MBP is opened, XLamp XT-E LEDs may be stored as MSL 1 per JEDEC J-STD-033, meaning they have unlimited floor life in conditions of  $\leq 30$  °C/85% relative humidity (RH). Regardless of the storage condition, Cree LED recommends sealing any unsoldered LEDs in the original MBP.

### RoHS Compliance

The levels of RoHS restricted materials in this product are below the maximum concentration values (also referred to as the threshold limits) permitted for such substances, or are used in an exempted application, in accordance with EU Directive 2011/65/EC (RoHS2), as implemented January 2, 2013. RoHS Declarations for this product can be obtained from your Cree LED representative or from the [Product Ecology](#) section of the Cree LED website.

### REACH Compliance

REACH substances of very high concern (SVHCs) information is available for this product. Since the European Chemical Agency (ECHA) has published notice of their intent to frequently revise the SVHC listing for the foreseeable future, please contact a Cree LED representative to insure you get the most up-to-date REACH SVHC Declaration. REACH banned substance information (REACH Article 67) is also available upon request.

## NOTES - CONTINUED

---

### **UL® Recognized Component**

This product meets the requirements to be considered a UL Recognized Component with Level 4 enclosure consideration. The LED package or a portion thereof has been investigated as a fire and electrical enclosure per ANSI/UL 8750.

### **Vision Advisory**

WARNING: Do not look at an exposed lamp in operation. Eye injury can result. For more information about LEDs and eye safety, please refer to the [LED Eye Safety application note](#).

**MECHANICAL DIMENSIONS**

Thermal vias, if present, are not shown on these drawings.  
 All measurements are ±0.13 mm unless otherwise indicated.

**XT-E White**

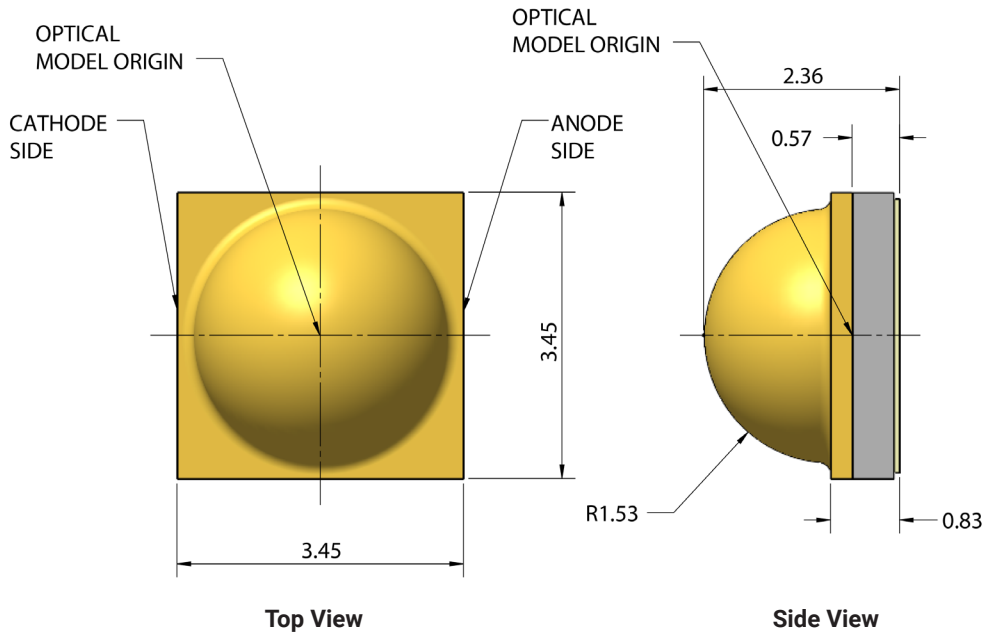

**XT-E Royal Blue**

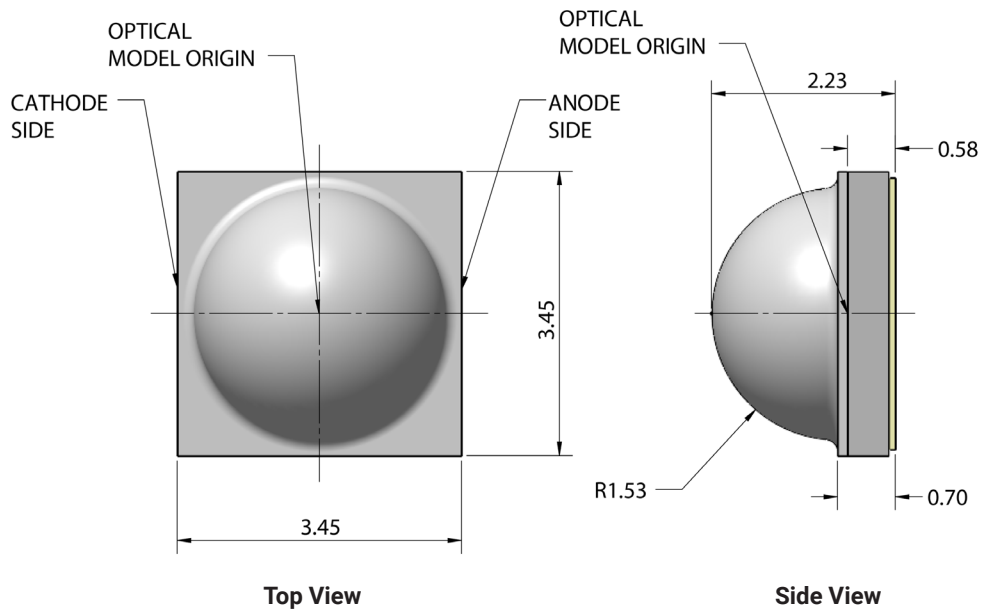

**MECHANICAL DIMENSIONS - CONTINUED**

**XT-E White & XT-E Royal Blue**

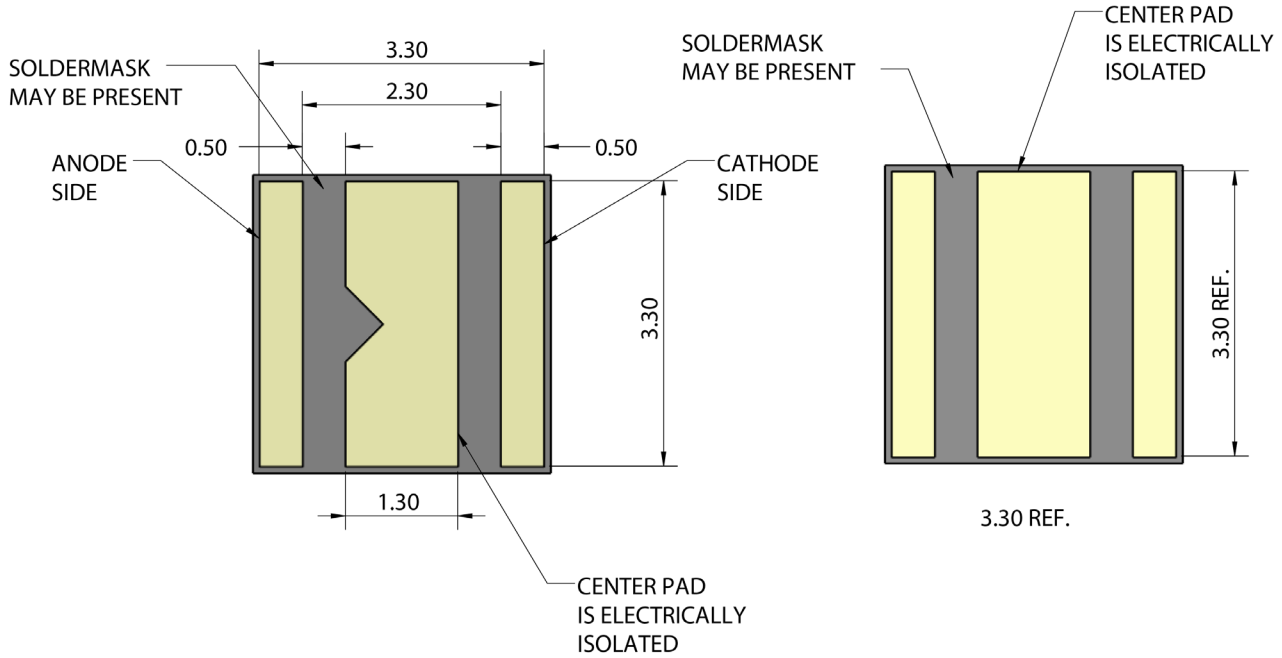

**Bottom View**

**Alternate Bottom View**

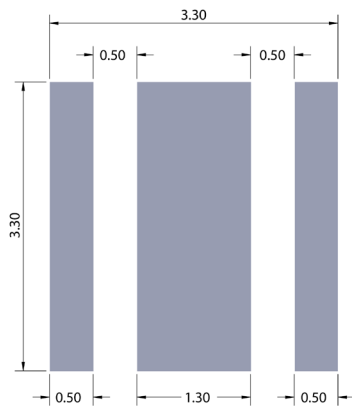

**Recommended PCB Footprint**

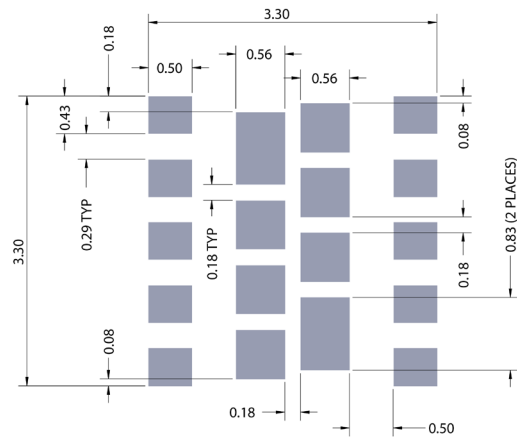

**Recommended Stencil Opening**

**TAPE AND REEL**

All Cree LED carrier tapes conform to EIA-481D, Automated Component Handling Systems Standard.

All dimensions in mm.

All measurements are  $\pm 0.13$  mm unless otherwise indicated.

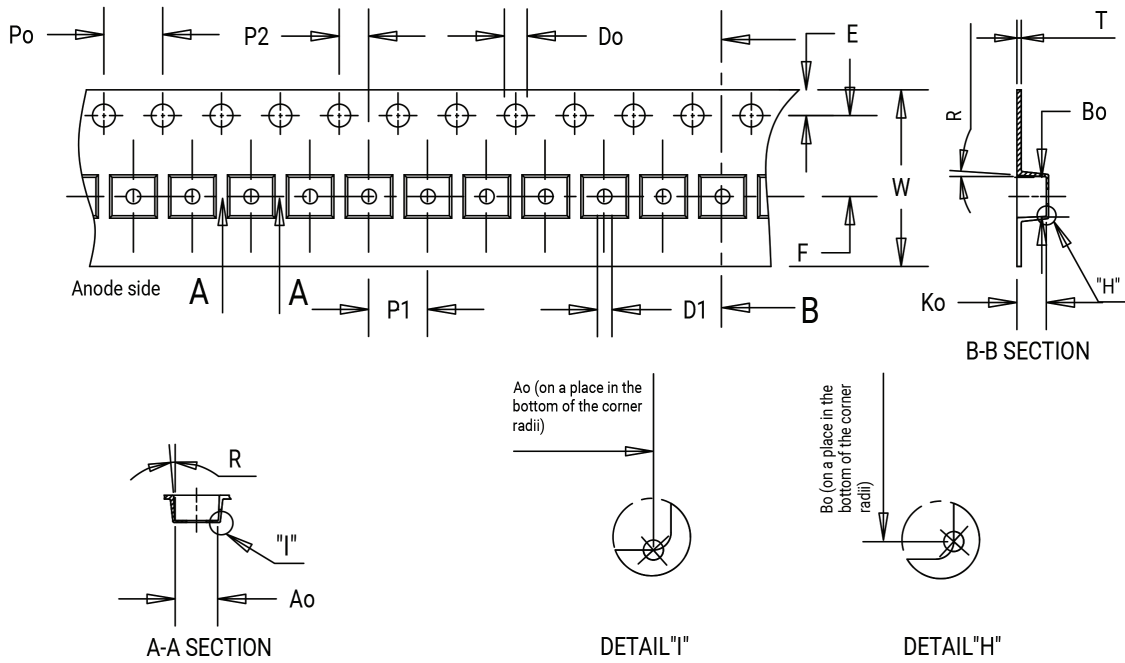

Item	Ao	Bo	Ko	Po	P1	P2	T	E	F	Do	D1	W	R
Dim.	3.70	3.70	2.40	4.00	8.00	2.00	0.30	1.75	5.50	1.55	1.50	12.00	5°

**TAPE AND REEL - CONTINUED**

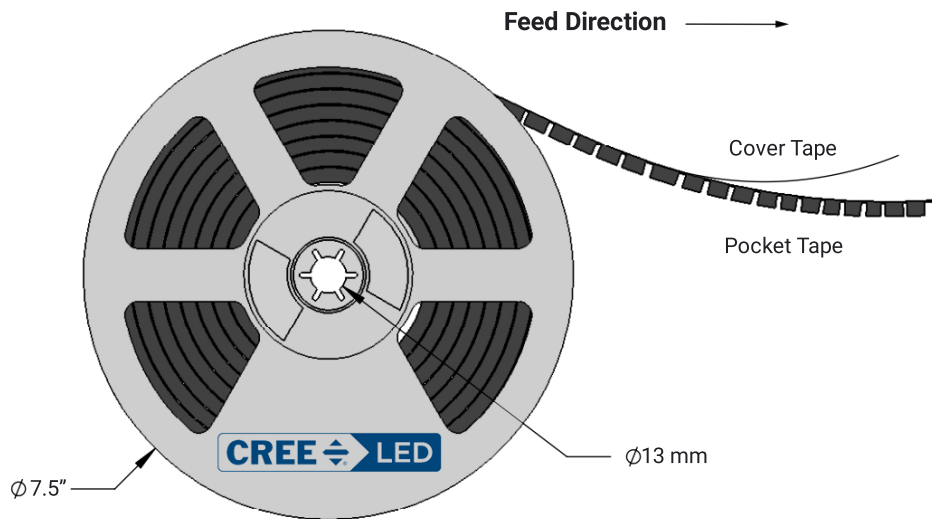
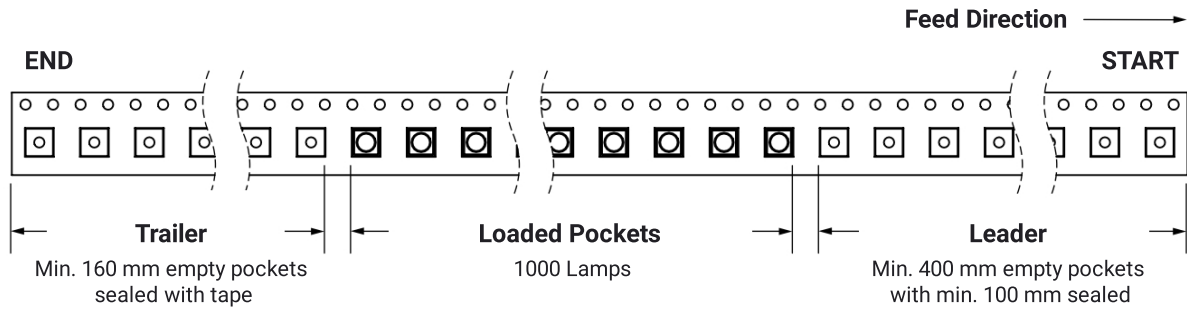

PACKAGING

**Unpackaged Reel**

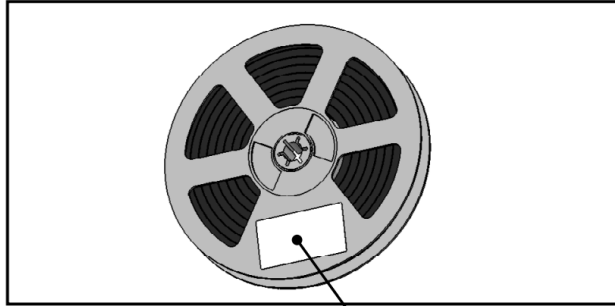

Label with Cree LED Bin Code, Quantity, Reel ID

**Packaged Reel**

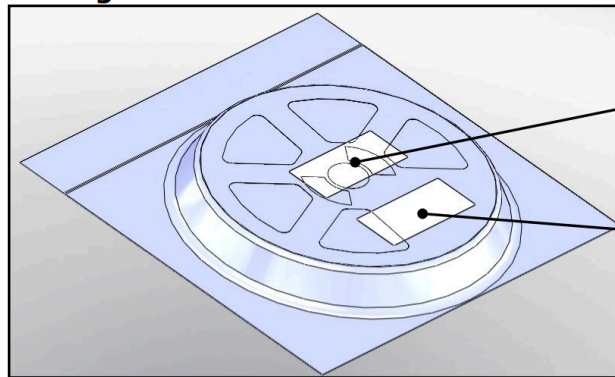

Label with Cree LED Order Code, Quantity, Reel ID, PO#

Label with Cree LED Bin Code, Quantity, Reel ID

**Boxed Reel**

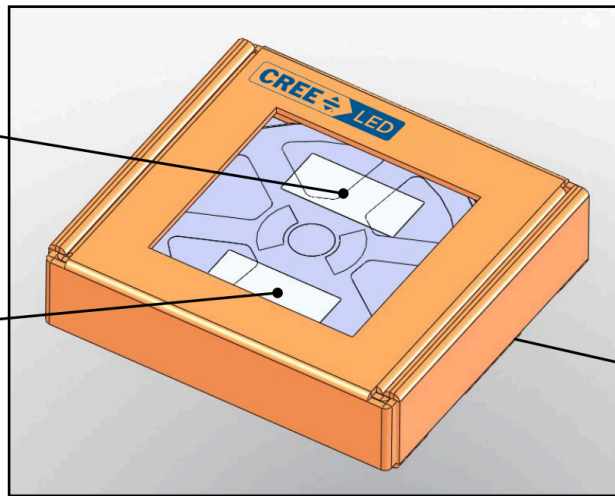

Label with Cree LED Order Code, Quantity, Reel ID, PO#

Label with Cree LED Bin Code, Quantity, Reel ID

Patent Label (on bottom of box)

**APPENDIX - ORDER CODES NOT FOR NEW DESIGNS**

The following order codes are active and valid order codes, but higher performance options are also available. Please see page 4 - page 10 for order codes of XLamp XT-E Standard white LEDs that could serve as alternatives for the order codes set forth below.

**XT-E Standard White (T<sub>J</sub> = 85 °C)**

Chromaticity		Minimum Luminous Flux (lm) @ 350 mA			Order Codes					
Kit	CCT	Code	Flux (lm) @ 85 °C	Flux (lm) @ 25 °C*	No Minimum CRI	70 CRI Minimum	75 CRI Typical	80 CRI Minimum	85 CRI Minimum	90 CRI Minimum
51	6200 K	R4	130	143	XTEAWT-00-0000-000000G51	XTEAWT-00-0000-000000BG51				
		R3	122	134	XTEAWT-00-0000-000000F51	XTEAWT-00-0000-000000BF51				
		R2	114	125	XTEAWT-00-0000-000000E51	XTEAWT-00-0000-000000BE51		XTEAWT-00-0000-000000HE51		
		Q5	107	118				XTEAWT-00-0000-000000HD51		
53	6000 K	R4	130	143	XTEAWT-00-0000-000000G53	XTEAWT-00-0000-000000BG53				
		R3	122	134	XTEAWT-00-0000-000000F53	XTEAWT-00-0000-000000BF53				
		R2	114	125	XTEAWT-00-0000-000000E53	XTEAWT-00-0000-000000BE53		XTEAWT-00-0000-000000HE53		
		Q5	107	118				XTEAWT-00-0000-000000HD53		
50	6200 K	R4	130	143	XTEAWT-00-0000-000000G50	XTEAWT-00-0000-000000BG50				
		R3	122	134	XTEAWT-00-0000-000000F50	XTEAWT-00-0000-000000BF50				
		R2	114	125	XTEAWT-00-0000-000000E50	XTEAWT-00-0000-000000BE50		XTEAWT-00-0000-000000HE50		
		Q5	107	118				XTEAWT-00-0000-000000HD50		
E1	6500 K	R4	130	143	XTEAWT-00-0000-000000GE1	XTEAWT-00-0000-000000BGE1				
		R3	122	134	XTEAWT-00-0000-000000FE1	XTEAWT-00-0000-000000BFE1				
		R2	114	125	XTEAWT-00-0000-000000EE1	XTEAWT-00-0000-000000BEE1		XTEAWT-00-0000-000000HEE1		
		Q5	107	118				XTEAWT-00-0000-000000HDE1		

**Notes:**

- Cree LED maintains a tolerance of ±7% on flux and power measurements, ±0.005 on chromaticity (CCx, CCy) measurements and ±2 on CRI measurements. See the Measurements section (page 39).
- XLamp XT-E LED order codes specify only a minimum flux bin and not a maximum. Cree LED may ship reels in flux bins higher than the minimum specified by the order code without advance notice. Shipments will always adhere to the chromaticity or DWL bin restrictions specified by the order code.
- Flux values @ 25 °C are calculated and for reference only.

APPENDIX - ORDER CODES NOT FOR NEW DESIGNS - CONTINUED

Chromaticity		Minimum Luminous Flux (lm) @ 350 mA			Order Codes					
Kit	CCT	Code	Flux (lm) @ 85 °C	Flux (lm) @ 25 °C*	No Minimum CRI	70 CRI Minimum	75 CRI Typical	80 CRI Minimum	85 CRI Minimum	90 CRI Minimum
E2	5700 K	R4	130	143	XTEAWT-00-0000-000000GE2	XTEAWT-00-0000-000000BGE2				
		R3	122	134	XTEAWT-00-0000-000000FE2	XTEAWT-00-0000-000000BFE2				
		R2	114	125	XTEAWT-00-0000-000000EE2	XTEAWT-00-0000-000000BEE2		XTEAWT-00-0000-000000HEE2		
		Q5	107	118				XTEAWT-00-0000-000000HDE2		
E3	5000 K	R4	130	143	XTEAWT-00-0000-000000GE3	XTEAWT-00-0000-000000BGE3				
		R3	122	134	XTEAWT-00-0000-000000FE3	XTEAWT-00-0000-000000BFE3	XTEAWT-00-0000-000000LFE3			
		R2	114	125	XTEAWT-00-0000-000000EE3	XTEAWT-00-0000-000000BEE3	XTEAWT-00-0000-000000LEE3	XTEAWT-00-0000-000000HEE3		
		Q5	107	118				XTEAWT-00-0000-000000HDE3		
		Q4	100	110						
		Q3	93.9	103					XTEAWT-00-0000-000000PBE3	XTEAWT-00-0000-000000UBE3
		Q2	87.4	96.1					XTEAWT-00-0000-000000PAE3	XTEAWT-00-0000-000000UAE3
C1	5000 K	R4	130	143	XTEAWT-00-0000-000000GC1	XTEAWT-00-0000-000000BGC1				
		R3	122	134	XTEAWT-00-0000-000000FC1	XTEAWT-00-0000-000000BFC1	XTEAWT-00-0000-000000LFC1			
		R2	114	125	XTEAWT-00-0000-000000EC1	XTEAWT-00-0000-000000BEC1	XTEAWT-00-0000-000000LEC1			
F4	4750 K	R4	130	143	XTEAWT-00-0000-000000GF4	XTEAWT-00-0000-000000BGF4				
		R3	122	134	XTEAWT-00-0000-000000FF4	XTEAWT-00-0000-000000BFF4	XTEAWT-00-0000-000000LFF4			
		R2	114	125	XTEAWT-00-0000-000000EF4	XTEAWT-00-0000-000000BEF4	XTEAWT-00-0000-000000LEF4			
		Q5	107	118			XTEAWT-00-0000-000000LDF4	XTEAWT-00-0000-000000HDF4		
		Q4	100	110						
		Q3	93.9	103					XTEAWT-00-0000-000000PBF4	XTEAWT-00-0000-000000UBF4
		Q2	87.4	96.1					XTEAWT-00-0000-000000PAF4	XTEAWT-00-0000-000000UAF4

Notes:

- Cree LED maintains a tolerance of ±7% on flux and power measurements, ±0.005 on chromaticity (CCx, CCy) measurements and ±2 on CRI measurements. See the Measurements section (page 39).
- XLamp XT-E LED order codes specify only a minimum flux bin and not a maximum. Cree LED may ship reels in flux bins higher than the minimum specified by the order code without advance notice. Shipments will always adhere to the chromaticity or DWL bin restrictions specified by the order code.
- Flux values @ 25 °C are calculated and for reference only.

APPENDIX - ORDER CODES NOT FOR NEW DESIGNS - CONTINUED

Chromaticity		Minimum Luminous Flux (lm) @ 350 mA			Order Codes						
Kit	CCT	Code	Flux (lm) @ 85 °C	Flux (lm) @ 25 °C*	No Minimum CRI	70 CRI Minimum	75 CRI Typical	80 CRI Minimum	85 CRI Minimum	90 CRI Minimum	
D1	4750 K	R4	130	143	XTEAWT-00-0000-000000GD1	XTEAWT-00-0000-000000BGD1					
		R3	122	134	XTEAWT-00-0000-000000FD1	XTEAWT-00-0000-000000BFD1	XTEAWT-00-0000-000000LFD1				
		R2	114	125	XTEAWT-00-0000-000000ED1	XTEAWT-00-0000-000000BED1	XTEAWT-00-0000-000000LED1				
E4	4500 K	R4	130	143	XTEAWT-00-0000-000000GE4	XTEAWT-00-0000-000000BGE4					
		R3	122	134	XTEAWT-00-0000-000000FE4	XTEAWT-00-0000-000000BFE4	XTEAWT-00-0000-000000LFE4				
		R2	114	125	XTEAWT-00-0000-000000EE4	XTEAWT-00-0000-000000BEE4	XTEAWT-00-0000-000000LEE4				
		Q5	107	118			XTEAWT-00-0000-000000LDE4	XTEAWT-00-0000-000000HDE4			
		Q4	100	110							
		Q3	93.9	103					XTEAWT-00-0000-000000PBE4	XTEAWT-00-0000-000000UBE4	
		Q2	87.4	96.1					XTEAWT-00-0000-000000PAE4	XTEAWT-00-0000-000000UAE4	
D2	4500 K	R4	130	143	XTEAWT-00-0000-000000GD2	XTEAWT-00-0000-000000BGD2					
		R3	122	134	XTEAWT-00-0000-000000FD2	XTEAWT-00-0000-000000BFD2	XTEAWT-00-0000-000000LFD2				
		R2	114	125	XTEAWT-00-0000-000000ED2	XTEAWT-00-0000-000000BED2	XTEAWT-00-0000-000000LED2				
		Q5	107	118			XTEAWT-00-0000-000000LDD2				
C2	4500 K	R4	130	143	XTEAWT-00-0000-000000GC2	XTEAWT-00-0000-000000BGC2					
		R3	122	134	XTEAWT-00-0000-000000FC2	XTEAWT-00-0000-000000BFC2	XTEAWT-00-0000-000000LFC2				
		R2	114	125	XTEAWT-00-0000-000000EC2	XTEAWT-00-0000-000000BEC2	XTEAWT-00-0000-000000LEC2				
C3	4300 K	R4	130	143	XTEAWT-00-0000-000000GC3	XTEAWT-00-0000-000000BGC3					
		R3	122	134	XTEAWT-00-0000-000000FC3	XTEAWT-00-0000-000000BFC3	XTEAWT-00-0000-000000LFC3				
		R2	114	125	XTEAWT-00-0000-000000EC3	XTEAWT-00-0000-000000BEC3	XTEAWT-00-0000-000000LEC3				

Notes:

- Cree LED maintains a tolerance of ±7% on flux and power measurements, ±0.005 on chromaticity (CCx, CCy) measurements and ±2 on CRI measurements. See the Measurements section (page 39).
- XLamp XT-E LED order codes specify only a minimum flux bin and not a maximum. Cree LED may ship reels in flux bins higher than the minimum specified by the order code without advance notice. Shipments will always adhere to the chromaticity or DWL bin restrictions specified by the order code.
- Flux values @ 25 °C are calculated and for reference only.

APPENDIX - ORDER CODES NOT FOR NEW DESIGNS - CONTINUED

Chromaticity		Minimum Luminous Flux (lm) @ 350 mA			Order Codes					
Kit	CCT	Code	Flux (lm) @ 85 °C	Flux (lm) @ 25 °C*	No Minimum CRI	70 CRI Minimum	75 CRI Typical	80 CRI Minimum	85 CRI Minimum	90 CRI Minimum
F5	4250 K	R4	130	143	XTEAWT-00-0000-000000GF5	XTEAWT-00-0000-000000BGF5				
		R3	122	134	XTEAWT-00-0000-000000FF5	XTEAWT-00-0000-000000BFF5				
		R2	114	125	XTEAWT-00-0000-000000EF5	XTEAWT-00-0000-000000BEF5	XTEAWT-00-0000-000000LEF5			
		Q5	107	118	XTEAWT-00-0000-000000DF5	XTEAWT-00-0000-000000BDF5	XTEAWT-00-0000-000000LDF5	XTEAWT-00-0000-000000HDF5		
		Q4	100	110			XTEAWT-00-0000-000000LCF5	XTEAWT-00-0000-000000HCF5		
		Q3	93.9	103						
		Q2	87.4	96.1					XTEAWT-00-0000-000000PAF5	XTEAWT-00-0000-000000UAF5
		P4	80.6	88.6					XTEAWT-00-0000-000000P9F5	XTEAWT-00-0000-000000U9F5
E5	4000 K	R4	130	143	XTEAWT-00-0000-000000GE5	XTEAWT-00-0000-000000BGE5				
		R3	122	134	XTEAWT-00-0000-000000FE5	XTEAWT-00-0000-000000BFE5				
		R2	114	125	XTEAWT-00-0000-000000EE5	XTEAWT-00-0000-000000BEE5	XTEAWT-00-0000-000000LEE5			
		Q5	107	118	XTEAWT-00-0000-000000DE5	XTEAWT-00-0000-000000BDE5	XTEAWT-00-0000-000000LDE5	XTEAWT-00-0000-000000HDE5		
		Q4	100	110			XTEAWT-00-0000-000000LCE5	XTEAWT-00-0000-000000HCE5		
		Q3	93.9	103						
		Q2	87.4	96.1					XTEAWT-00-0000-000000PAE5	XTEAWT-00-0000-000000UAE5
		P4	80.6	88.6					XTEAWT-00-0000-000000P9E5	XTEAWT-00-0000-000000U9E5
F6	3750 K	R2	114	125	XTEAWT-00-0000-000000EF6	XTEAWT-00-0000-000000BEF6	XTEAWT-00-0000-000000LEF6			
		Q5	107	118	XTEAWT-00-0000-000000DF6	XTEAWT-00-0000-000000BDF6	XTEAWT-00-0000-000000LDF6			
		Q4	100	110			XTEAWT-00-0000-000000LCF6	XTEAWT-00-0000-000000HCF6		
		Q3	93.9	103						
		Q2	87.4	96.1					XTEAWT-00-0000-000000PAF6	XTEAWT-00-0000-000000UAF6
		P4	80.6	88.6					XTEAWT-00-0000-000000P9F6	XTEAWT-00-0000-000000U9F6

Notes:

- Cree LED maintains a tolerance of ±7% on flux and power measurements, ±0.005 on chromaticity (CCx, CCy) measurements and ±2 on CRI measurements. See the Measurements section (page 39).
- XLamp XT-E LED order codes specify only a minimum flux bin and not a maximum. Cree LED may ship reels in flux bins higher than the minimum specified by the order code without advance notice. Shipments will always adhere to the chromaticity or DWL bin restrictions specified by the order code.
- Flux values @ 25 °C are calculated and for reference only.

APPENDIX - ORDER CODES NOT FOR NEW DESIGNS - CONTINUED

Chromaticity		Minimum Luminous Flux (lm) @ 350 mA			Order Codes					
Kit	CCT	Code	Flux (lm) @ 85 °C	Flux (lm) @ 25 °C*	No Minimum CRI	70 CRI Minimum	75 CRI Typical	80 CRI Minimum	85 CRI Minimum	90 CRI Minimum
E6	3500 K	R2	114	125	XTEAWT-00-0000-000000EE6	XTEAWT-00-0000-00000BEE6	XTEAWT-00-0000-00000LEE6			
		Q5	107	118	XTEAWT-00-0000-000000DE6	XTEAWT-00-0000-00000BDE6	XTEAWT-00-0000-00000LDE6			
		Q4	100	110			XTEAWT-00-0000-00000LCE6	XTEAWT-00-0000-00000HCE6		
		Q3	93.9	103						
		Q2	87.4	96.1					XTEAWT-00-0000-00000PAE6	XTEAWT-00-0000-00000UAE6
		P4	80.6	88.6					XTEAWT-00-0000-00000P9E6	XTEAWT-00-0000-00000U9E6
F7	3250 K	R2	114	125	XTEAWT-00-0000-000000EF7	XTEAWT-00-0000-00000BEF7				
		Q5	107	118	XTEAWT-00-0000-000000DF7	XTEAWT-00-0000-00000BDF7	XTEAWT-00-0000-00000LDF7			
		Q4	100	110	XTEAWT-00-0000-000000CF7	XTEAWT-00-0000-00000BCF7	XTEAWT-00-0000-00000LCF7	XTEAWT-00-0000-00000HCF7		
		Q3	93.9	103			XTEAWT-00-0000-00000LBF7	XTEAWT-00-0000-00000HBF7		
		Q2	87.4	96.1						
		P4	80.6	88.6					XTEAWT-00-0000-00000P9F7	XTEAWT-00-0000-00000U9F7
		P3	73.9	81.2					XTEAWT-00-0000-00000P8F7	XTEAWT-00-0000-00000U8F7
E7	3000 K	R2	114	125	XTEAWT-00-0000-000000EE7	XTEAWT-00-0000-00000BEE7				
		Q5	107	118	XTEAWT-00-0000-000000DE7	XTEAWT-00-0000-00000BDE7	XTEAWT-00-0000-00000LDE7			
		Q4	100	110	XTEAWT-00-0000-000000CE7	XTEAWT-00-0000-00000BCE7	XTEAWT-00-0000-00000LCE7	XTEAWT-00-0000-00000HCE7		
		Q3	93.9	103			XTEAWT-00-0000-00000LBE7	XTEAWT-00-0000-00000HBE7		
		Q2	87.4	96.1						
		P4	80.6	88.6					XTEAWT-00-0000-00000P9E7	XTEAWT-00-0000-00000U9E7
		P3	73.9	81.2					XTEAWT-00-0000-00000P8E7	XTEAWT-00-0000-00000U8E7

Notes:

- Cree LED maintains a tolerance of ±7% on flux and power measurements, ±0.005 on chromaticity (CCx, CCy) measurements and ±2 on CRI measurements. See the Measurements section (page 39).
- XLamp XT-E LED order codes specify only a minimum flux bin and not a maximum. Cree LED may ship reels in flux bins higher than the minimum specified by the order code without advance notice. Shipments will always adhere to the chromaticity or DWL bin restrictions specified by the order code.
- Flux values @ 25 °C are calculated and for reference only.

APPENDIX - ORDER CODES NOT FOR NEW DESIGNS - CONTINUED

Chromaticity		Minimum Luminous Flux (lm) @ 350 mA			Order Codes					
Kit	CCT	Code	Flux (lm) @ 85 °C	Flux (lm) @ 25 °C*	No Minimum CRI	70 CRI Minimum	75 CRI Typical	80 CRI Minimum	85 CRI Minimum	90 CRI Minimum
F8	2850 K	Q5	107	118	XTEAWT-00-0000-00000DF8	XTEAWT-00-0000-00000BDF8				
		Q4	100	110	XTEAWT-00-0000-00000CF8	XTEAWT-00-0000-00000BCF8	XTEAWT-00-0000-00000LCF8	XTEAWT-00-0000-00000HCF8		
		Q3	93.9	103	XTEAWT-00-0000-00000BF8	XTEAWT-00-0000-00000BBF8	XTEAWT-00-0000-00000LBF8	XTEAWT-00-0000-00000HBF8		
		Q2	87.4	96.1			XTEAWT-00-0000-00000LAF8	XTEAWT-00-0000-00000HAF8		
		P4	80.6	88.6					XTEAWT-00-0000-00000P9F8	
		P3	73.9	81.2					XTEAWT-00-0000-00000P8F8	XTEAWT-00-0000-00000U8F8
E8	2700 K	Q5	107	118	XTEAWT-00-0000-00000DE8	XTEAWT-00-0000-00000BDE8				
		Q4	100	110	XTEAWT-00-0000-00000CE8	XTEAWT-00-0000-00000BCE8	XTEAWT-00-0000-00000LCE8	XTEAWT-00-0000-00000HCE8		
		Q3	93.9	103	XTEAWT-00-0000-00000BE8	XTEAWT-00-0000-00000BBE8	XTEAWT-00-0000-00000LBE8	XTEAWT-00-0000-00000HBE8		
		Q2	87.4	96.1			XTEAWT-00-0000-00000LAE8	XTEAWT-00-0000-00000HAE8		
		P4	80.6	88.6					XTEAWT-00-0000-00000P9E8	
		P3	73.9	81.2					XTEAWT-00-0000-00000P8E8	XTEAWT-00-0000-00000U8E8

Notes:

- Cree LED maintains a tolerance of ±7% on flux and power measurements, ±0.005 on chromaticity (CCx, CCy) measurements and ±2 on CRI measurements. See the Measurements section (page 39).
- XLamp XT-E LED order codes specify only a minimum flux bin and not a maximum. Cree LED may ship reels in flux bins higher than the minimum specified by the order code without advance notice. Shipments will always adhere to the chromaticity or DWL bin restrictions specified by the order code.
- Flux values @ 25 °C are calculated and for reference only.

**APPENDIX - ORDER CODES NOT FOR NEW DESIGNS - CONTINUED**

The following order codes are active and valid order codes, but higher performance options are also available. Please see page 11 - page 18 for order codes of XLamp XT-E High-Efficacy white LEDs that could serve as alternatives for the order codes set forth below.

**XT-E High-Efficacy White (T<sub>J</sub> = 85 °C)**

Chromaticity		Minimum Luminous Flux (lm) @ 350 mA			Order Codes			
Kit	CCT	Code	Flux (lm) @ 85 °C	Flux (lm) @ 25 °C*	No Minimum CRI	70 CRI Minimum	80 CRI Minimum	90 CRI Minimum
51	6200 K	S2	148	163	XTEAWT-E0-0000-000000J51	XTEAWT-E0-0000-00000BJ51		
		R5	139	153	XTEAWT-E0-0000-000000H51	XTEAWT-E0-0000-00000BH51		
		R4	130	143	XTEAWT-E0-0000-000000G51	XTEAWT-E0-0000-00000BG51	XTEAWT-E0-0000-00000HG51	
		R3	122	134			XTEAWT-E0-0000-00000HF51	
		R2	114	125			XTEAWT-E0-0000-00000HE51	
53	6000 K	S2	148	163	XTEAWT-E0-0000-000000J53	XTEAWT-E0-0000-00000BJ53		
		R5	139	153	XTEAWT-E0-0000-000000H53	XTEAWT-E0-0000-00000BH53		
		R4	130	143	XTEAWT-E0-0000-000000G53	XTEAWT-E0-0000-00000BG53	XTEAWT-E0-0000-00000HG53	
		R3	122	134			XTEAWT-E0-0000-00000HF53	
		R2	114	125			XTEAWT-E0-0000-00000HE53	
50	6200 K	S2	148	163	XTEAWT-E0-0000-000000J50	XTEAWT-E0-0000-00000BJ50		
		R5	139	153	XTEAWT-E0-0000-000000H50	XTEAWT-E0-0000-00000BH50		
		R4	130	143	XTEAWT-E0-0000-000000G50	XTEAWT-E0-0000-00000BG50	XTEAWT-E0-0000-00000HG50	
		R3	122	134			XTEAWT-E0-0000-00000HF50	
		R2	114	125			XTEAWT-E0-0000-00000HE50	
E1	6500 K	S2	148	163	XTEAWT-E0-0000-000000JE1	XTEAWT-E0-0000-00000BJE1		
		R5	139	153	XTEAWT-E0-0000-000000HE1	XTEAWT-E0-0000-00000BHE1		
		R4	130	143	XTEAWT-E0-0000-000000GE1	XTEAWT-E0-0000-00000BGE1	XTEAWT-E0-0000-00000HGE1	
		R3	122	134			XTEAWT-E0-0000-00000HFE1	
		R2	114	125			XTEAWT-E0-0000-00000HEE1	
1E	6500 K	S2	148	163	XTEAWT-E0-0000-000000JE1	XTEAWT-E0-0000-00000BJE1		
		R5	139	153	XTEAWT-E0-0000-000000H1E	XTEAWT-E0-0000-00000BH1E		
		R4	130	143			XTEAWT-E0-0000-00000HG1E	
1G	6500 K	S2	148	163	XTEAWT-E0-0000-000000J1G	XTEAWT-E0-0000-00000BJ1G		
		R5	139	153	XTEAWT-E0-0000-000000H1G	XTEAWT-E0-0000-00000BH1G		
E2	5700 K	S2	148	163	XTEAWT-E0-0000-000000JE2	XTEAWT-E0-0000-00000BJE2		
		R5	139	153	XTEAWT-E0-0000-000000HE2	XTEAWT-E0-0000-00000BHE2		
		R4	130	143	XTEAWT-E0-0000-000000GE2	XTEAWT-E0-0000-00000BGE2	XTEAWT-E0-0000-00000HGE2	
		R3	122	134			XTEAWT-E0-0000-00000HFE2	
		R2	114	125			XTEAWT-E0-0000-00000HEE2	

**Notes:**

- Cree LED maintains a tolerance of ±7% on flux and power measurements, ±0.005 on chromaticity (CCx, CCy) measurements and ±2 on CRI measurements. See the Measurements section (page 39).
- XLamp XT-E LED order codes specify only a minimum flux bin and not a maximum. Cree LED may ship reels in flux bins higher than the minimum specified by the order code without advance notice. Shipments will always adhere to the chromaticity or DWL bin restrictions specified by the order code.
- Flux values @ 25 °C are calculated and for reference only.

APPENDIX - ORDER CODES NOT FOR NEW DESIGNS - CONTINUED

Chromaticity		Minimum Luminous Flux (lm) @ 350 mA			Order Codes			
Kit	CCT	Code	Flux (lm) @ 85 °C	Flux (lm) @ 25 °C*	No Minimum CRI	70 CRI Minimum	80 CRI Minimum	90 CRI Minimum
2E	5700 K	S2	148	163	XTEAWT-E0-0000-000000J2E	XTEAWT-E0-0000-000000BJ2E		
		R5	139	153	XTEAWT-E0-0000-000000H2E	XTEAWT-E0-0000-000000BH2E		
2G	5700 K	S2	148	163	XTEAWT-E0-0000-000000J2G	XTEAWT-E0-0000-000000BJ2G		
		R5	139	153	XTEAWT-E0-0000-000000H2G	XTEAWT-E0-0000-000000BH2G		
E3	5000 K	S2	148	163	XTEAWT-E0-0000-000000JE3	XTEAWT-E0-0000-000000BJE3		
		R5	139	153	XTEAWT-E0-0000-000000HE3	XTEAWT-E0-0000-000000BHE3		
		R4	130	143	XTEAWT-E0-0000-000000GE3	XTEAWT-E0-0000-000000BGE3	XTEAWT-E0-0000-000000HGE3	
		R3	122	134			XTEAWT-E0-0000-000000HFE3	
		R2	114	125			XTEAWT-E0-0000-000000HEE3	XTEAWT-E0-0000-000000UEE3
		Q5	107	118				XTEAWT-E0-0000-000000UDE3
		Q4	100	110				XTEAWT-E0-0000-000000UCE3
		Q3	93.9	103				XTEAWT-E0-0000-000000UBE3
		Q2	87.4	96.1				XTEAWT-E0-0000-000000UAE3
3E	5000 K	S2	148	163	XTEAWT-E0-0000-000000J3E	XTEAWT-E0-0000-000000BJ3E		
3G	5000 K	S2	148	163	XTEAWT-E0-0000-000000J3G	XTEAWT-E0-0000-000000BJ3G		
F4	4750 K	R4	130	143			XTEAWT-E0-0000-000000HGF4	
		R3	122	134			XTEAWT-E0-0000-000000HFF4	
		R2	114	125			XTEAWT-E0-0000-000000HEF4	XTEAWT-E0-0000-000000UEF4
		Q5	107	118				XTEAWT-E0-0000-000000UDF4
		Q4	100	110				XTEAWT-E0-0000-000000UCF4
		Q3	93.9	103				XTEAWT-E0-0000-000000UBF4
		Q2	87.4	96.1				XTEAWT-E0-0000-000000UAF4
E4	4500 K	S2	148	163	XTEAWT-E0-0000-000000JE4	XTEAWT-E0-0000-000000BJE4		
		R5	139	153	XTEAWT-E0-0000-000000HE4	XTEAWT-E0-0000-000000BHE4		
		R4	130	143	XTEAWT-E0-0000-000000GE4	XTEAWT-E0-0000-000000BGE4	XTEAWT-E0-0000-000000HGE4	
		R3	122	134			XTEAWT-E0-0000-000000HFE4	
		R2	114	125			XTEAWT-E0-0000-000000HEE4	XTEAWT-E0-0000-000000UEE4
		Q5	107	118				XTEAWT-E0-0000-000000UDE4
		Q4	100	110				XTEAWT-E0-0000-000000UCE4
		Q3	93.9	103				XTEAWT-E0-0000-000000UBE4
		Q2	87.4	96.1				XTEAWT-E0-0000-000000UAE4
4E	4500 K	S2	148	163	XTEAWT-E0-0000-000000J4E	XTEAWT-E0-0000-000000BJ4E		
		R5	139	153				
		R4	130	143			XTEAWT-E0-0000-000000HG4E	

Notes:

- Cree LED maintains a tolerance of ±7% on flux and power measurements, ±0.005 on chromaticity (CCx, CCy) measurements and ±2 on CRI measurements. See the Measurements section (page 39).
- XLamp XT-E LED order codes specify only a minimum flux bin and not a maximum. Cree LED may ship reels in flux bins higher than the minimum specified by the order code without advance notice. Shipments will always adhere to the chromaticity or DWL bin restrictions specified by the order code.
- Flux values @ 25 °C are calculated and for reference only.

APPENDIX - ORDER CODES NOT FOR NEW DESIGNS - CONTINUED

Chromaticity		Minimum Luminous Flux (lm) @ 350 mA			Order Codes			
Kit	CCT	Code	Flux (lm) @ 85 °C	Flux (lm) @ 25 °C*	No Minimum CRI	70 CRI Minimum	80 CRI Minimum	90 CRI Minimum
4G	4500 K	S2	148	163	XTEAWT-E0-0000-000000J4G	XTEAWT-E0-0000-000000BJ4G		
		R5	139	153				
		R4	130	143			XTEAWT-E0-0000-000000HG4G	
F5	4250 K	S2	148	163	XTEAWT-E0-0000-000000JF5	XTEAWT-E0-0000-000000BJF5		
		R5	139	153	XTEAWT-E0-0000-000000HF5	XTEAWT-E0-0000-000000BHF5		
		R4	130	143	XTEAWT-E0-0000-000000GF5	XTEAWT-E0-0000-000000BGF5	XTEAWT-E0-0000-000000HGF5	
		R3	122	134			XTEAWT-E0-0000-000000HFF5	
		R2	114	125			XTEAWT-E0-0000-000000HEF5	
		Q5	107	118			XTEAWT-E0-0000-000000HDF5	XTEAWT-E0-0000-000000UDF5
		Q4	100	110				XTEAWT-E0-0000-000000UCF5
		Q3	93.9	103				XTEAWT-E0-0000-000000UBF5
		Q2	87.4	96.1				XTEAWT-E0-0000-000000UAF5
P4	80.6	88.6				XTEAWT-E0-0000-000000U9F5		
E5	4000 K	S2	148	163	XTEAWT-E0-0000-000000JE5	XTEAWT-E0-0000-000000BJE5		
		R5	139	153	XTEAWT-E0-0000-000000HE5	XTEAWT-E0-0000-000000BHE5		
		R4	130	143	XTEAWT-E0-0000-000000GE5	XTEAWT-E0-0000-000000BGE5	XTEAWT-E0-0000-000000HGE5	
		R3	122	134			XTEAWT-E0-0000-000000HFE5	
		R2	114	125			XTEAWT-E0-0000-000000HEE5	
		Q5	107	118			XTEAWT-E0-0000-000000HDE5	XTEAWT-E0-0000-000000UDE5
		Q4	100	110				XTEAWT-E0-0000-000000UCE5
		Q3	93.9	103				XTEAWT-E0-0000-000000UBE5
		Q2	87.4	96.1				XTEAWT-E0-0000-000000UAE5
P4	80.6	88.6				XTEAWT-E0-0000-000000U9E5		
5E	4000 K	S2	148	163	XTEAWT-E0-0000-000000J5E	XTEAWT-E0-0000-000000BJ5E		
		R5	139	153				
		R4	130	143			XTEAWT-E0-0000-000000HG5E	
5G	4000 K	S2	148	163	XTEAWT-E0-0000-000000J5G	XTEAWT-E0-0000-000000BJ5G		
		R5	139	153				
		R4	130	143			XTEAWT-E0-0000-000000HG5G	

Notes:

- Cree LED maintains a tolerance of ±7% on flux and power measurements, ±0.005 on chromaticity (CCx, CCy) measurements and ±2 on CRI measurements. See the Measurements section (page 39).
- XLamp XT-E LED order codes specify only a minimum flux bin and not a maximum. Cree LED may ship reels in flux bins higher than the minimum specified by the order code without advance notice. Shipments will always adhere to the chromaticity or DWL bin restrictions specified by the order code.
- Flux values @ 25 °C are calculated and for reference only.

APPENDIX - ORDER CODES NOT FOR NEW DESIGNS - CONTINUED

Chromaticity		Minimum Luminous Flux (lm) @ 350 mA			Order Codes			
Kit	CCT	Code	Flux (lm) @ 85 °C	Flux (lm) @ 25 °C*	No Minimum CRI	70 CRI Minimum	80 CRI Minimum	90 CRI Minimum
F6	3750 K	R5	139	153	XTEAWT-E0-0000-000000HF6	XTEAWT-E0-0000-000000BH6		
		R4	130	143	XTEAWT-E0-0000-000000GF6	XTEAWT-E0-0000-000000BG6		
		R3	122	134	XTEAWT-E0-0000-000000FF6	XTEAWT-E0-0000-000000BF6	XTEAWT-E0-0000-000000HF6	
		R2	114	125	XTEAWT-E0-0000-000000EF6	XTEAWT-E0-0000-000000BE6	XTEAWT-E0-0000-000000HE6	
		Q5	107	118			XTEAWT-E0-0000-000000HD6	
		Q4	100	110			XTEAWT-E0-0000-000000HC6	XTEAWT-E0-0000-000000UC6
		Q3	93.9	103				XTEAWT-E0-0000-000000UB6
		Q2	87.4	96.1				XTEAWT-E0-0000-000000UA6
		P4	80.6	88.6				XTEAWT-E0-0000-000000U96
E6	3500 K	R5	139	153	XTEAWT-E0-0000-000000HE6	XTEAWT-E0-0000-000000BHE6		
		R4	130	143	XTEAWT-E0-0000-000000GE6	XTEAWT-E0-0000-000000BGE6		
		R3	122	134	XTEAWT-E0-0000-000000FE6	XTEAWT-E0-0000-000000BFE6	XTEAWT-E0-0000-000000HFE6	
		R2	114	125	XTEAWT-E0-0000-000000EE6	XTEAWT-E0-0000-000000BEE6	XTEAWT-E0-0000-000000HEE6	
		Q5	107	118			XTEAWT-E0-0000-000000HDE6	
		Q4	100	110			XTEAWT-E0-0000-000000HCE6	XTEAWT-E0-0000-000000UCE6
		Q3	93.9	103				XTEAWT-E0-0000-000000UBE6
		Q2	87.4	96.1				XTEAWT-E0-0000-000000UAE6
		P4	80.6	88.6				XTEAWT-E0-0000-000000U9E6
6E	3500 K	R5	139	153	XTEAWT-E0-0000-000000H6E	XTEAWT-E0-0000-000000BH6E		
		R4	130	143				
		R3	122	134			XTEAWT-E0-0000-000000HF6E	
6G	3500 K	R5	139	153	XTEAWT-E0-0000-000000H6G	XTEAWT-E0-0000-000000BH6G		
		R4	130	143				
		R3	122	134			XTEAWT-E0-0000-000000HF6G	
F7	3250 K	R5	139	153	XTEAWT-E0-0000-000000HF7	XTEAWT-E0-0000-000000BH7		
		R4	130	143	XTEAWT-E0-0000-000000GF7	XTEAWT-E0-0000-000000BG7		
		R3	122	134	XTEAWT-E0-0000-000000FF7	XTEAWT-E0-0000-000000BF7	XTEAWT-E0-0000-000000HF7	
		R2	114	125	XTEAWT-E0-0000-000000EF7	XTEAWT-E0-0000-000000BE7	XTEAWT-E0-0000-000000HE7	
		Q5	107	118	XTEAWT-E0-0000-000000DF7	XTEAWT-E0-0000-000000BD7	XTEAWT-E0-0000-000000HD7	
		Q4	100	110			XTEAWT-E0-0000-000000HC7	XTEAWT-E0-0000-000000UC7
		Q3	93.9	103				XTEAWT-E0-0000-000000UB7
		Q2	87.4	96.1				XTEAWT-E0-0000-000000UA7
		P4	80.6	88.6				XTEAWT-E0-0000-000000U97
P3	73.9	81.2				XTEAWT-E0-0000-000000U87		

Notes:

- Cree LED maintains a tolerance of ±7% on flux and power measurements, ±0.005 on chromaticity (CCx, CCy) measurements and ±2 on CRI measurements. See the Measurements section (page 39).
- XLamp XT-E LED order codes specify only a minimum flux bin and not a maximum. Cree LED may ship reels in flux bins higher than the minimum specified by the order code without advance notice. Shipments will always adhere to the chromaticity or DWL bin restrictions specified by the order code.
- Flux values @ 25 °C are calculated and for reference only.

APPENDIX - ORDER CODES NOT FOR NEW DESIGNS - CONTINUED

Chromaticity		Minimum Luminous Flux (lm) @ 350 mA			Order Codes			
Kit	CCT	Code	Flux (lm) @ 85 °C	Flux (lm) @ 25 °C*	No Minimum CRI	70 CRI Minimum	80 CRI Minimum	90 CRI Minimum
E7	3000 K	R5	139	153	XTEAWT-E0-0000-000000HE7	XTEAWT-E0-0000-00000BHE7		
		R4	130	143	XTEAWT-E0-0000-000000GE7	XTEAWT-E0-0000-00000BGE7		
		R3	122	134	XTEAWT-E0-0000-000000FE7	XTEAWT-E0-0000-00000BFE7		
		R2	114	125	XTEAWT-E0-0000-000000EE7	XTEAWT-E0-0000-00000BEE7	XTEAWT-E0-0000-00000HEE7	
		Q5	107	118	XTEAWT-E0-0000-000000DE7	XTEAWT-E0-0000-00000BDE7	XTEAWT-E0-0000-00000HDE7	
		Q4	100	110			XTEAWT-E0-0000-00000HCE7	XTEAWT-E0-0000-00000UCE7
		Q3	93.9	103				XTEAWT-E0-0000-00000UBE7
		Q2	87.4	96.1				XTEAWT-E0-0000-00000UAE7
		P4	80.6	88.6				XTEAWT-E0-0000-00000U9E7
P3	73.9	81.2				XTEAWT-E0-0000-00000U8E7		
7E	3000 K	R5	139	153	XTEAWT-E0-0000-000000H7E	XTEAWT-E0-0000-00000BH7E		
		R4	130	143	XTEAWT-E0-0000-000000G7E	XTEAWT-E0-0000-00000BG7E		
7G	3000 K	R5	139	153	XTEAWT-E0-0000-000000H7G	XTEAWT-E0-0000-00000BH7G		
		R4	130	143	XTEAWT-E0-0000-000000G7G			
F8	2850 K	R4	130	143	XTEAWT-E0-0000-000000GF8	XTEAWT-E0-0000-00000BGF8		
		R3	122	134	XTEAWT-E0-0000-000000FF8	XTEAWT-E0-0000-00000BFF8		
		R2	114	125	XTEAWT-E0-0000-000000EF8	XTEAWT-E0-0000-00000BEF8	XTEAWT-E0-0000-00000HEF8	
		Q5	107	118	XTEAWT-E0-0000-000000DF8	XTEAWT-E0-0000-00000BDF8	XTEAWT-E0-0000-00000HDF8	
		Q4	100	110	XTEAWT-E0-0000-000000CF8	XTEAWT-E0-0000-00000BCF8	XTEAWT-E0-0000-00000HCF8	
		Q3	93.9	103			XTEAWT-E0-0000-00000HBF8	XTEAWT-E0-0000-00000UBF8
		Q2	87.4	96.1				XTEAWT-E0-0000-00000UAF8
		P4	80.6	88.6				XTEAWT-E0-0000-00000U9F8
		P3	73.9	81.2				XTEAWT-E0-0000-00000U8F8
E8	2700 K	R4	130	143	XTEAWT-E0-0000-000000GE8	XTEAWT-E0-0000-00000BGE8		
		R3	122	134	XTEAWT-E0-0000-000000FE8	XTEAWT-E0-0000-00000BFE8		
		R2	114	125	XTEAWT-E0-0000-000000EE8	XTEAWT-E0-0000-00000BEE8	XTEAWT-E0-0000-00000HEE8	
		Q5	107	118	XTEAWT-E0-0000-000000DE8	XTEAWT-E0-0000-00000BDE8	XTEAWT-E0-0000-00000HDE8	
		Q4	100	110	XTEAWT-E0-0000-000000CE8	XTEAWT-E0-0000-00000BCE8	XTEAWT-E0-0000-00000HCE8	
		Q3	93.9	103			XTEAWT-E0-0000-00000HBE8	XTEAWT-E0-0000-00000UBE8
		Q2	87.4	96.1				XTEAWT-E0-0000-00000UAE8
		P4	80.6	88.6				XTEAWT-E0-0000-00000U9E8
		P3	73.9	81.2				XTEAWT-E0-0000-00000U8E8

Notes:

- Cree LED maintains a tolerance of ±7% on flux and power measurements, ±0.005 on chromaticity (CCx, CCy) measurements and ±2 on CRI measurements. See the Measurements section (page 39).
- XLamp XT-E LED order codes specify only a minimum flux bin and not a maximum. Cree LED may ship reels in flux bins higher than the minimum specified by the order code without advance notice. Shipments will always adhere to the chromaticity or DWL bin restrictions specified by the order code.
- Flux values @ 25 °C are calculated and for reference only.

APPENDIX - ORDER CODES NOT FOR NEW DESIGNS - CONTINUED

Chromaticity		Minimum Luminous Flux (lm) @ 350 mA			Order Codes			
Kit	CCT	Code	Flux (lm) @ 85 °C	Flux (lm) @ 25 °C*	No Minimum CRI	70 CRI Minimum	80 CRI Minimum	90 CRI Minimum
8E	2700 K	R4	130	143	XTEAWT-E0-0000-000000G8E	XTEAWT-E0-0000-00000BG8E		
		R3	122	134				
		R2	114	125			XTEAWT-E0-0000-00000HE8E	
8G	2700 K	R4	130	143	XTEAWT-E0-0000-000000G8G	XTEAWT-E0-0000-00000BG8G		
		R3	122	134				
		R2	114	125			XTEAWT-E0-0000-00000HE8G	
EA	2200 K	R2	114	125		XTEAWT-E0-0000-00000BEEA		
		Q5	107	118		XTEAWT-E0-0000-00000BDEA		
		Q4	100	110		XTEAWT-E0-0000-00000BCEA	XTEAWT-E0-0000-00000HCEA	
		Q3	93.9	103		XTEAWT-E0-0000-00000BBEA	XTEAWT-E0-0000-00000HBEA	
		Q2	87.4	96.1		XTEAWT-E0-0000-00000BAEA	XTEAWT-E0-0000-00000HAEA	
		P4	80.6	88.6		XTEAWT-E0-0000-00000B9EA	XTEAWT-E0-0000-00000H9EA	
		P3	73.9	81.2			XTEAWT-E0-0000-00000H8EA	
AE	2200 K	R2	114	125		XTEAWT-E0-0000-00000BEAE		
		Q5	107	118		XTEAWT-E0-0000-00000BDAE		
		Q4	100	110			XTEAWT-E0-0000-00000HCAE	
		Q3	93.9	103			XTEAWT-E0-0000-00000HBAE	
AG	2200 K	R2	114	125		XTEAWT-E0-0000-00000BEAG		
		Q5	107	118		XTEAWT-E0-0000-00000BDAG		
		Q4	100	110			XTEAWT-E0-0000-00000HCAG	
		Q3	93.9	103			XTEAWT-E0-0000-00000HBAG	

Notes:

- Cree LED maintains a tolerance of ±7% on flux and power measurements, ±0.005 on chromaticity (CCx, CCy) measurements and ±2 on CRI measurements. See the Measurements section (page 39).
- XLamp XT-E LED order codes specify only a minimum flux bin and not a maximum. Cree LED may ship reels in flux bins higher than the minimum specified by the order code without advance notice. Shipments will always adhere to the chromaticity or DWL bin restrictions specified by the order code.
- Flux values @ 25 °C are calculated and for reference only.

**APPENDIX - ORDER CODES NOT FOR NEW DESIGNS - CONTINUED**

The following order codes are active and valid order codes, but higher performance options are also available. Please see page 18 for order codes of XLamp XT-E royal blue LEDs that could serve as alternatives for the order codes set forth below.



**XT-E Royal Blue (T<sub>j</sub> = 85 °C)**

DWL Kit Codes	Dominant Wavelength Range				Order Codes, Minimum Radiant Flux @ 350 mA, T <sub>j</sub> =85 °C		
	Minimum		Maximum		550 mW - Radiant Flux Group Code 34(N)	575 mW - Radiant Flux Group Code 35 (P)	600 mW - Radiant Flux Group Code 36 (Q)
	Group	DWL (nm)	Group	DWL (nm)			
						Calculated PPF (μmol/s) = 2.08	Calculated PPF (μmol/s) = 2.18
01	D36	450	D57	465	XTEARY-00-0000-000000N01	XTEARY-00-0000-000000P01	XTEARY-00-0000-000000Q01
02	D36	450	D47	460		XTEARY-00-0000-000000P02	XTEARY-00-0000-000000Q02
03	D46	455	D57	465	XTEARY-00-0000-000000N03	XTEARY-00-0000-000000P03	XTEARY-00-0000-000000Q03
04	D36	450	D37	455			XTEARY-00-0000-000000Q04
05	D46	455	D47	460		XTEARY-00-0000-000000P05	XTEARY-00-0000-000000Q05
06	D56	460	D57	465	XTEARY-00-0000-000000N06	XTEARY-00-0000-000000P06	
07	D37	452.5	D46	457.5		XTEARY-00-0000-000000P07	XTEARY-00-0000-000000Q07
08	D47	457.5	D56	462.5	XTEARY-00-0000-000000N08	XTEARY-00-0000-000000P08	
09	D37	452.5	D56	462.5	XTEARY-00-0000-000000N09	XTEARY-00-0000-000000P09	XTEARY-00-0000-000000Q09

- Note:**
- Cree LED maintains a tolerance of ±7% on flux and power measurements, ±0.005 on chromaticity (CCx, CCy) measurements, ±2 on CRI measurements and ±1 nm on dominant wavelength measurements. See the Measurements section (page 39).
  - XT-E LED order codes specify only a minimum flux bin and not a maximum. Cree LED may ship reels in flux bins higher than the minimum specified by the order code without advance notice. Shipments will always adhere to the chromaticity or DWL bin restrictions specified by the order code.
  - Calculated Photosynthetic Photon Flux (PPF) values are for reference only.

## Looking for pricing, stock, or lifecycle information?

Click below to explore more details on WIN SOURCE:

-  [View XTEAWT-00-0000-00000BEE3 on WIN SOURCE](#)
-  [CreeLED, Inc. Information](#)

## Optimize Your Supply Chain with WIN SOURCE Solutions

-  Global Sourcing Solution
-  Obsolete Management
-  Cost Control Management
-  Shortage Management
-  Alternative Solution
-  Excess Inventory Management