

XLamp® XB-D LEDs

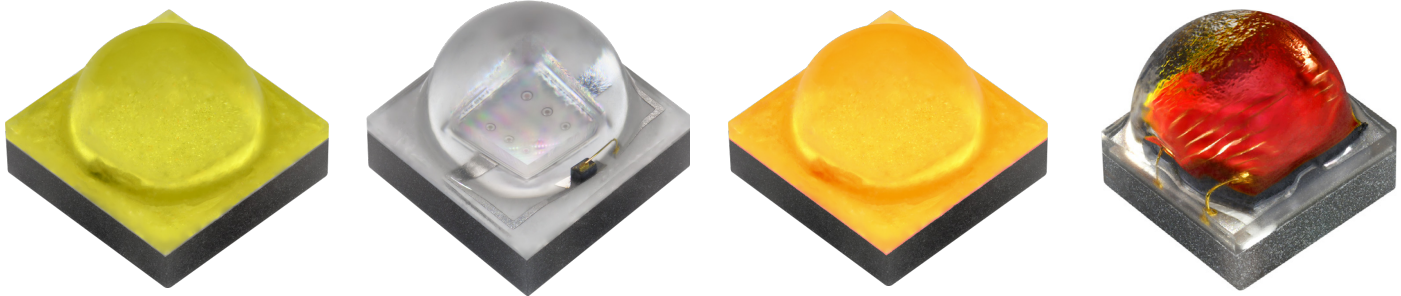

PRODUCT DESCRIPTION

The XLamp® XB-D LED brings next-generation performance, price and size to all LED lighting applications. The XB-D's footprint enables smaller designs with densely packed arrays for better light mixing and concentration.

The XB-D shares common footprint and uniform package design across all white and color configurations, simplifying board and optical designs for many LED systems. The XB-D is optimized to dramatically lower system cost in any illumination application, from indoor and outdoor lighting to architectural and transportation lighting.

FEATURES

- XB-D white binned @ 85 °C; XB-D color binned @ 25 °C
- Up to 136 lm/W in cool white (@ 85 °C, 350 mA)
- Available in white, 80-minimum CRI white, and 70-minimum CRI cool white, royal blue, blue, green, PC amber, amber, red-orange & red
- 1 A maximum drive current
- Wide viewing angle: from 110° (PC amber) to 140° (red)
- Reflow solderable - JEDEC J-STD-020C compatible
- Unlimited floor life at ≤ 30 °C/85% RH
- Electrically neutral thermal path
- RoHS and REACH compliant
- UL® recognized component (E349212)



Cree LED / 4001 E. Hwy. 54, Suite 2000 / Durham, NC 27709 USA / +1.919.313.5330 / www.cree-led.com

TABLE OF CONTENTS

Characteristics	3
Order Codes Suggested for New Designs - White	4
Order Codes Suggested for New Designs - Color	10
Relative Spectral Power Distribution	14
Relative Flux vs. Junction Temperature.....	15
Electrical Characteristics - White	16
Electrical Characteristics - Color.....	16
Relative Flux vs. Current - White.....	17
Relative Flux vs. Current - Color	17
Relative Chromaticity vs. Current.....	18
Relative Chromaticity vs. Temperature.....	19
Typical Spatial Distribution.....	19
Thermal Design	20
Performance Groups – Luminous Flux.....	21
Performance Groups – Radiant Flux	22
Performance Groups – Dominant Wavelength	22
Performance Groups – Forward Voltage	23
Performance Groups – Chromaticity.....	23
Standard Cool White Kits Plotted on ANSI Standard Chromaticity Regions.....	27
Standard Warm and Neutral White Kits Plotted on ANSI Standard Chromaticity Regions	28
Cree LED’s PC Amber Kit Plotted on the 1931 CIE Curve.....	29
Cree LED’s Standard Chromaticity Kits.....	29
Bin and Order Code Formats	30
Reflow Soldering Characteristics.....	31
Notes	32
Mechanical Dimensions	34
Tape and Reel.....	37
Packaging.....	39
Appendix - Order Codes Not For New Designs	40

CHARACTERISTICS

Characteristics	Unit	Minimum	Typical	Maximum
Thermal resistance, junction to solder point - white, royal blue, blue	°C/W		6.5	
Thermal resistance, junction to solder point - green	°C/W		11	
Thermal resistance, junction to solder point - PC amber	°C/W		8.5	
Thermal resistance, junction to solder point - amber	°C/W		7.8	
Thermal resistance, junction to solder point - red-orange, red	°C/W		5	
Viewing angle (FWHM) - white	degrees		115	
Viewing angle (FWHM) - royal blue	degrees		120	
Viewing angle (FWHM) - blue, green	degrees		125	
Viewing angle (FWHM) - PC amber,	degrees		110	
Viewing angle (FWHM) - amber, red-orange, red	degrees		140	
Temperature coefficient of voltage - white	mV/°C		-1.2	
Temperature coefficient of voltage - royal blue	mV/°C		-2.0	
Temperature coefficient of voltage - blue, green	mV/°C		-1.2	
Temperature coefficient of voltage - PC amber	mV/°C		-2.4	
Temperature coefficient of voltage - amber, red-orange, red	mV/°C		-1.8	
ESD classification (HBM per Mil-Std-883D)			Class 3B	
DC forward current	mA			1000
Reverse voltage	V			1
Forward voltage (@ 350 mA, 85 °C) - white	V		2.9	3.5
Forward voltage (@ 350 mA, 25 °C) - royal blue	V		2.95	3.5
Forward voltage (@ 350 mA, 25 °C) - blue	V		2.95	3.5
Forward voltage (@ 350 mA, 25 °C) - green	V		2.97	3.4
Forward voltage (@ 350 mA, 25 °C) - PC amber	V		3.1	3.4
Forward voltage (@ 350 mA, 25 °C) - amber, red-orange, red	V		2.17	2.6
LED junction temperature	°C			150

ORDER CODES SUGGESTED FOR NEW DESIGNS - WHITE (T_J = 85 °C)

The following tables provide order codes for XLamp XB-D white LEDs. For a complete description of the order-code nomenclature, please consult the Bin and Order Formats section (page 30).

Chromaticity		Minimum Luminous Flux (lm) @ 350 mA*			Calculated Minimum Luminous Flux (lm)**		Order Codes		
Kit	CCT	Code	Flux (lm) @ 85 °C	Flux (lm) @ 25 °C*	700 mA	1000 mA	No CRI Minimum	70 CRI Minimum	80 CRI Minimum

ANSI Cool White (5000 K – 8300 K)

51	6200 K	R5	139	156	239	308	XBDAWT-00-0000-000000H51	XBDAWT-00-0000-000000BH51	
		R4	130	148	224	289	XBDAWT-00-0000-000000G51	XBDAWT-00-0000-000000BG51	XBDAWT-00-0000-000000HG51
		R3	122	139	210	271	XBDAWT-00-0000-000000F51	XBDAWT-00-0000-000000BF51	XBDAWT-00-0000-000000HF51
		R2	114	130	196	253			XBDAWT-00-0000-000000HE51
53	6000 K	R5	139	156	239	308	XBDAWT-00-0000-000000H53	XBDAWT-00-0000-000000BH53	
		R4	130	148	224	289	XBDAWT-00-0000-000000G53	XBDAWT-00-0000-000000BG53	XBDAWT-00-0000-000000HG53
		R3	122	139	210	271	XBDAWT-00-0000-000000F53	XBDAWT-00-0000-000000BF53	XBDAWT-00-0000-000000HF53
		R2	114	130	196	253			XBDAWT-00-0000-000000HE53
50	6200 K	R5	139	156	239	308	XBDAWT-00-0000-000000H50	XBDAWT-00-0000-000000BH50	
		R4	130	148	224	289	XBDAWT-00-0000-000000G50	XBDAWT-00-0000-000000BG50	XBDAWT-00-0000-000000HG50
		R3	122	139	210	271	XBDAWT-00-0000-000000F50	XBDAWT-00-0000-000000BF50	XBDAWT-00-0000-000000HF50
		R2	114	130	196	253			XBDAWT-00-0000-000000HE50

Notes:

- For additional order codes NOT recommended for new designs please see the Appendix section starting on page 40 .
- Cree LED maintains a tolerance of ±7% on flux and power measurements, ±0.005 on chromaticity (CCx, CCy) measurements and ±2 on CRI measurements. See the Measurements section (page 32).
- XLamp XB-D LED order codes specify only a minimum flux bin and not a maximum. Cree LED may ship reels in flux bins higher than the minimum specified by the order code without advance notice. Shipments will always adhere to the chromaticity or DWL bin restrictions specified by the order code.
- Typical CRI for Neutral White, 3700 K - 5000 K CCT is 75.
- Typical CRI for Warm White, 2600 K - 3700 K CCT is 80.
- Minimum CRI for 70 CRI Minimum Cool White is 70.
- Minimum CRI for 80 CRI Minimum White is 80.
- * Flux values @ 25 °C are calculated and are for reference only.
- ** Calculated flux values at 700 mA and 1000 mA are for 85 °C and are for reference only.

ORDER CODES SUGGESTED FOR NEW DESIGNS - WHITE (T_J = 85 °C) - CONTINUED

Chromaticity		Minimum Luminous Flux (lm) @ 350 mA*			Calculated Minimum Luminous Flux (lm)**		Order Codes		
Kit	CCT	Code	Flux (lm) @ 85 °C	Flux (lm) @ 25 °C*	700 mA	1000 mA	No CRI Minimum	70 CRI Minimum	80 CRI Minimum
ANSI Cool White (5000 K – 8300 K)									
E1	6500 K	R5	139	156	239	308	XBDAWT-00-0000-000000HE1	XBDAWT-00-0000-000000BHE1	
		R4	130	148	224	289	XBDAWT-00-0000-000000GE1	XBDAWT-00-0000-000000BGE1	XBDAWT-00-0000-000000HGE1
		R3	122	139	210	271	XBDAWT-00-0000-000000FE1	XBDAWT-00-0000-000000BFE1	XBDAWT-00-0000-000000HFE1
		R2	114	130	196	253			XBDAWT-00-0000-000000HEE1
E2	5700 K	R5	139	156	239	308	XBDAWT-00-0000-000000HE2	XBDAWT-00-0000-000000BHE2	
		R4	130	148	224	289	XBDAWT-00-0000-000000GE2	XBDAWT-00-0000-000000BGE2	XBDAWT-00-0000-000000HGE2
		R3	122	139	210	271	XBDAWT-00-0000-000000FE2	XBDAWT-00-0000-000000BFE2	XBDAWT-00-0000-000000HFE2
		R2	114	130	196	253			XBDAWT-00-0000-000000HEE2

Notes:

- For additional order codes NOT recommended for new designs please see the Appendix section starting on page 40 .
- Cree LED maintains a tolerance of ±7% on flux and power measurements, ±0.005 on chromaticity (CCx, CCy) measurements and ±2 on CRI measurements. See the Measurements section (page 32).
- XLamp XB-D LED order codes specify only a minimum flux bin and not a maximum. Cree LED may ship reels in flux bins higher than the minimum specified by the order code without advance notice. Shipments will always adhere to the chromaticity or DWL bin restrictions specified by the order code.
- Typical CRI for Neutral White, 3700 K - 5000 K CCT is 75.
- Typical CRI for Warm White, 2600 K - 3700 K CCT is 80.
- Minimum CRI for 70 CRI Minimum Cool White is 70.
- Minimum CRI for 80 CRI Minimum White is 80.
- * Flux values @ 25 °C are calculated and are for reference only.
- ** Calculated flux values at 700 mA and 1000 mA are for 85 °C and are for reference only.

ORDER CODES SUGGESTED FOR NEW DESIGNS - WHITE (T_J = 85 °C) - CONTINUED

Chromaticity		Minimum Luminous Flux (lm) @ 350 mA*			Calculated Minimum Luminous Flux (lm)**		Order Codes			
Kit	CCT	Code	Flux (lm) @ 85 °C	Flux (lm) @ 25 °C*	700 mA	1000 mA	No CRI Minimum	70 CRI Minimum	Standard CRI	80 CRI Minimum
ANSI Neutral White (3700 K – 5000 K)										
E3	5000 K	R5	139	156	239	308	XBDAWT-00-0000-000000HE3	XBDAWT-00-0000-000000BHE3		
		R4	130	148	224	289	XBDAWT-00-0000-000000GE3	XBDAWT-00-0000-000000BGE3	XBDAWT-00-0000-000000LGE3	XBDAWT-00-0000-000000HGE3
		R3	122	139	210	271	XBDAWT-00-0000-000000FE3	XBDAWT-00-0000-000000BFE3	XBDAWT-00-0000-000000LFE3	XBDAWT-00-0000-000000HFE3
		R2	114	130	196	253			XBDAWT-00-0000-000000LEE3	XBDAWT-00-0000-000000HEE3
F4	4750 K	R5	139	156	239	308	XBDAWT-00-0000-000000HF4	XBDAWT-00-0000-000000BHF4		
		R4	130	148	224	289	XBDAWT-00-0000-000000GF4	XBDAWT-00-0000-000000BGF4	XBDAWT-00-0000-000000LGF4	XBDAWT-00-0000-000000HGF4
		R3	122	139	210	271	XBDAWT-00-0000-000000FF4	XBDAWT-00-0000-000000BFF4	XBDAWT-00-0000-000000LFF4	XBDAWT-00-0000-000000HFF4
		R2	114	130	196	253			XBDAWT-00-0000-000000LEF4	XBDAWT-00-0000-000000HEF4
E4	4500 K	R5	139	156	239	308	XBDAWT-00-0000-000000HE4	XBDAWT-00-0000-000000BHE4		
		R4	130	148	224	289	XBDAWT-00-0000-000000GE4	XBDAWT-00-0000-000000BGE4	XBDAWT-00-0000-000000LGE4	XBDAWT-00-0000-000000HGE4
		R3	122	139	210	271	XBDAWT-00-0000-000000FE4	XBDAWT-00-0000-000000BFE4	XBDAWT-00-0000-000000LFE4	XBDAWT-00-0000-000000HFE4
		R2	114	130	196	253			XBDAWT-00-0000-000000LEE4	XBDAWT-00-0000-000000HEE4
F5	4250 K	R4	130	148	224	289	XBDAWT-00-0000-000000GF5	XBDAWT-00-0000-000000BGF5	XBDAWT-00-0000-000000LGF5	XBDAWT-00-0000-000000HGF5
		R3	122	139	210	271	XBDAWT-00-0000-000000FF5	XBDAWT-00-0000-000000BFF5	XBDAWT-00-0000-000000LFF5	XBDAWT-00-0000-000000HFF5
		R2	114	130	196	253	XBDAWT-00-0000-000000EF5	XBDAWT-00-0000-000000BEF5	XBDAWT-00-0000-000000LEF5	XBDAWT-00-0000-000000HEF5

Notes:

- For additional order codes NOT recommended for new designs please see the Appendix section starting on page 40 .
- Cree LED maintains a tolerance of ±7% on flux and power measurements, ±0.005 on chromaticity (CCx, CCy) measurements and ±2 on CRI measurements. See the Measurements section (page 32).
- XLamp XB-D LED order codes specify only a minimum flux bin and not a maximum. Cree LED may ship reels in flux bins higher than the minimum specified by the order code without advance notice. Shipments will always adhere to the chromaticity or DWL bin restrictions specified by the order code.
- Typical CRI for Neutral White, 3700 K - 5000 K CCT is 75.
- Typical CRI for Warm White, 2600 K - 3700 K CCT is 80.
- Minimum CRI for 70 CRI Minimum Cool White is 70.
- Minimum CRI for 80 CRI Minimum White is 80.
- * Flux values @ 25 °C are calculated and are for reference only.
- ** Calculated flux values at 700 mA and 1000 mA are for 85 °C and are for reference only.

ORDER CODES SUGGESTED FOR NEW DESIGNS - WHITE (T_J = 85 °C) - CONTINUED

Chromaticity		Minimum Luminous Flux (lm) @ 350 mA*			Calculated Minimum Luminous Flux (lm)**		Order Codes			
Kit	CCT	Code	Flux (lm) @ 85 °C	Flux (lm) @ 25 °C*	700 mA	1000 mA	No CRI Minimum	70 CRI Minimum	Standard CRI	80 CRI Minimum
ANSI Neutral White (3700 K – 5000 K)										
E5	4000 K	R4	130	148	224	289	XBDAWT-00-0000-000000GE5	XBDAWT-00-0000-000000BGE5	XBDAWT-00-0000-000000LGE5	XBDAWT-00-0000-000000HGE5
		R3	122	139	210	271	XBDAWT-00-0000-000000FE5	XBDAWT-00-0000-000000BFE5	XBDAWT-00-0000-000000LFE5	XBDAWT-00-0000-000000HFE5
		R2	114	130	196	253	XBDAWT-00-0000-000000EE5	XBDAWT-00-0000-000000BEE5	XBDAWT-00-0000-000000LEE5	XBDAWT-00-0000-000000HEE5

Notes:

- For additional order codes NOT recommended for new designs please see the Appendix section starting on page 40 .
- Cree LED maintains a tolerance of ±7% on flux and power measurements, ±0.005 on chromaticity (CCx, CCy) measurements and ±2 on CRI measurements. See the Measurements section (page 32).
- XLamp XB-D LED order codes specify only a minimum flux bin and not a maximum. Cree LED may ship reels in flux bins higher than the minimum specified by the order code without advance notice. Shipments will always adhere to the chromaticity or DWL bin restrictions specified by the order code.
- Typical CRI for Neutral White, 3700 K - 5000 K CCT is 75.
- Typical CRI for Warm White, 2600 K - 3700 K CCT is 80.
- Minimum CRI for 70 CRI Minimum Cool White is 70.
- Minimum CRI for 80 CRI Minimum White is 80.
- * Flux values @ 25 °C are calculated and are for reference only.
- ** Calculated flux values at 700 mA and 1000 mA are for 85 °C and are for reference only.

ORDER CODES SUGGESTED FOR NEW DESIGNS - WHITE (T_j = 85 °C) - CONTINUED

Chromaticity		Minimum Luminous Flux (lm) @ 350 mA*			Calculated Minimum Luminous Flux (lm)**		Order Codes					
Kit	CCT	Code	Flux (lm) @ 85 °C	Flux (lm) @ 25 °C*	700 mA	1000 mA	No CRI Minimum	70 CRI Minimum	Standard CRI	80 CRI Minimum	90 CRI Minimum	
ANSI Warm White (2700 K - 3750 K)												
F6	3750 K	R4	130	148	224	289	XBDAWT-00-0000-000000GF6	XBDAWT-00-0000-000000BGF6				
		R3	122	139	210	271	XBDAWT-00-0000-000000FF6	XBDAWT-00-0000-000000BFF6	XBDAWT-00-0000-000000LFF6	XBDAWT-00-0000-000000HFF6		
		R2	114	130	196	253	XBDAWT-00-0000-000000EF6	XBDAWT-00-0000-000000BEF6	XBDAWT-00-0000-000000LEF6	XBDAWT-00-0000-000000HEF6		
		Q5	107	122	184	237	XBDAWT-00-0000-000000DF6	XBDAWT-00-0000-000000BDF6	XBDAWT-00-0000-000000LDF6	XBDAWT-00-0000-000000HDF6		
E6	3500 K	R4	130	148	224	289	XBDAWT-00-0000-000000GE6	XBDAWT-00-0000-000000BGE6				
		R3	122	139	210	271	XBDAWT-00-0000-000000FE6	XBDAWT-00-0000-000000BFE6	XBDAWT-00-0000-000000LFE6	XBDAWT-00-0000-000000HFE6		
		R2	114	130	196	253	XBDAWT-00-0000-000000EE6	XBDAWT-00-0000-000000BEE6	XBDAWT-00-0000-000000LEE6	XBDAWT-00-0000-000000HEE6		
		Q5	107	122	184	237	XBDAWT-00-0000-000000DE6	XBDAWT-00-0000-000000BDE6	XBDAWT-00-0000-000000LDE6	XBDAWT-00-0000-000000HDE6		
F7	3250 K	R3	122	139	210	271	XBDAWT-00-0000-000000FF7	XBDAWT-00-0000-000000BFF7	XBDAWT-00-0000-000000LFF7	XBDAWT-00-0000-000000HFF7		
		R2	114	130	196	253	XBDAWT-00-0000-000000EF7	XBDAWT-00-0000-000000BEF7	XBDAWT-00-0000-000000LEF7	XBDAWT-00-0000-000000HEF7		
		Q5	107	122	184	237	XBDAWT-00-0000-000000DF7	XBDAWT-00-0000-000000BDF7	XBDAWT-00-0000-000000LDF7	XBDAWT-00-0000-000000HDF7		
		Q4	100	114	172	222						
		Q3	93.9	107	162	208						
		Q2	87.4	100	150	194						XBDAWT-00-0000-000000UAF7
		P4	80.6	93	139	179						XBDAWT-00-0000-000000U9F7

Notes:

- For additional order codes NOT recommended for new designs please see the Appendix section starting on page 40 .
- Cree LED maintains a tolerance of ±7% on flux and power measurements, ±0.005 on chromaticity (CCx, CCy) measurements and ±2 on CRI measurements. See the Measurements section (page 32).
- XLamp XB-D LED order codes specify only a minimum flux bin and not a maximum. Cree LED may ship reels in flux bins higher than the minimum specified by the order code without advance notice. Shipments will always adhere to the chromaticity or DWL bin restrictions specified by the order code.
- Typical CRI for Neutral White, 3700 K - 5000 K CCT is 75.
- Typical CRI for Warm White, 2600 K - 3700 K CCT is 80.
- Minimum CRI for 70 CRI Minimum Cool White is 70.
- Minimum CRI for 80 CRI Minimum White is 80.
- * Flux values @ 25 °C are calculated and are for reference only.
- ** Calculated flux values at 700 mA and 1000 mA are for 85 °C and are for reference only.

ORDER CODES SUGGESTED FOR NEW DESIGNS - WHITE (T_J = 85 °C) - CONTINUED

Chromaticity		Minimum Luminous Flux (lm) @ 350 mA*			Calculated Minimum Luminous Flux (lm)**		Order Codes					
Kit	CCT	Code	Flux (lm) @ 85 °C	Flux (lm) @ 25 °C*	700 mA	1000 mA	No CRI Minimum	70 CRI Minimum	Standard CRI	80 CRI Minimum	90 CRI Minimum	
ANSI Warm White (2700 K - 3750 K)												
E7	3000 K	R3	122	139	210	271	XBDAWT-00-0000-000000FE7	XBDAWT-00-0000-000000BFE7	XBDAWT-00-0000-000000LFE7	XBDAWT-00-0000-000000HFE7		
		R2	114	130	196	253	XBDAWT-00-0000-000000EE7	XBDAWT-00-0000-000000BEE7	XBDAWT-00-0000-000000LEE7	XBDAWT-00-0000-000000HEE7		
		Q5	107	122	184	237	XBDAWT-00-0000-000000DE7	XBDAWT-00-0000-000000BDE7	XBDAWT-00-0000-000000LDE7	XBDAWT-00-0000-000000HDE7		
		Q4	100	114	172	222						
		Q3	93.9	107	162	208						
		Q2	87.4	100	150	194						XBDAWT-00-0000-000000UAE7
		P4	80.6	93	139	179						XBDAWT-00-0000-000000U9E7
F8	2850 K	R2	114	130	196	253	XBDAWT-00-0000-000000EF8	XBDAWT-00-0000-000000BEF8	XBDAWT-00-0000-000000LEF8	XBDAWT-00-0000-000000HEF8		
		Q5	107	122	184	237	XBDAWT-00-0000-000000DF8	XBDAWT-00-0000-000000BDF8	XBDAWT-00-0000-000000LDF8	XBDAWT-00-0000-000000HDF8		
		Q4	100	114	172	222	XBDAWT-00-0000-000000CF8	XBDAWT-00-0000-000000BCF8	XBDAWT-00-0000-000000LCF8	XBDAWT-00-0000-000000HCF8		
		Q3	93.9	107	162	208						
		Q2	87.4	100	150	194						XBDAWT-00-0000-000000UAF8
		P4	80.6	93	139	179						XBDAWT-00-0000-000000U9F8
E8	2700 K	R2	114	130	196	253	XBDAWT-00-0000-000000EE8	XBDAWT-00-0000-000000BEE8	XBDAWT-00-0000-000000LEE8	XBDAWT-00-0000-000000HEE8		
		Q5	107	122	184	237	XBDAWT-00-0000-000000DE8	XBDAWT-00-0000-000000BDE8	XBDAWT-00-0000-000000LDE8	XBDAWT-00-0000-000000HDE8		
		Q4	100	114	172	222	XBDAWT-00-0000-000000CE8	XBDAWT-00-0000-000000BCE8	XBDAWT-00-0000-000000LCE8	XBDAWT-00-0000-000000HCE8		
		Q3	93.9	107	162	208						
		Q2	87.4	100	150	194						XBDAWT-00-0000-000000UAE8
		P4	80.6	93	139	179						XBDAWT-00-0000-000000U9E8

Notes:

- For additional order codes NOT recommended for new designs please see the Appendix section starting on page 40 .
 - Cree LED maintains a tolerance of ±7% on flux and power measurements, ±0.005 on chromaticity (CCx, CCy) measurements and ±2 on CRI measurements. See the Measurements section (page 32).
 - XLamp XB-D LED order codes specify only a minimum flux bin and not a maximum. Cree LED may ship reels in flux bins higher than the minimum specified by the order code without advance notice. Shipments will always adhere to the chromaticity or DWL bin restrictions specified by the order code.
 - Typical CRI for Neutral White, 3700 K - 5000 K CCT is 75.
 - Typical CRI for Warm White, 2600 K - 3700 K CCT is 80.
 - Minimum CRI for 70 CRI Minimum Cool White is 70.
 - Minimum CRI for 80 CRI Minimum White is 80.
- * Flux values @ 25 °C are calculated and are for reference only.
- ** Calculated flux values at 700 mA and 1000 mA are for 85 °C and are for reference only.

ORDER CODES SUGGESTED FOR NEW DESIGNS - COLOR (T_J = 25 °C)

The following tables provide order codes for XLamp XB-D color LEDs. For a complete description of the order-code nomenclature, please consult the Bin and Order Formats section (page 30).

Royal Blue		Minimum Radiant Flux (mW) @ 350 mA		Order Codes
Kit	Dominant Wavelength (nm)	Code	Flux (mW)	
01	450 - 465	38	650	XBDROY-00-0000-000000S01
		37	625	XBDROY-00-0000-000000R01
		36	600	XBDROY-00-0000-000000Q01
		35	575	XBDROY-00-0000-000000P01
		34	550	XBDROY-00-0000-000000N01
02	450 - 460	38	650	XBDROY-00-0000-000000S02
		37	625	XBDROY-00-0000-000000R02
		36	600	XBDROY-00-0000-000000Q02
		35	575	XBDROY-00-0000-000000P02
		34	550	XBDROY-00-0000-000000N02
03	455 - 465	37	625	XBDROY-00-0000-000000R03
		36	600	XBDROY-00-0000-000000Q03
		35	575	XBDROY-00-0000-000000P03
		34	550	XBDROY-00-0000-000000N03
04	450 - 455	38	650	XBDROY-00-0000-000000S04
		37	625	XBDROY-00-0000-000000R04
		36	600	XBDROY-00-0000-000000Q04
		35	575	XBDROY-00-0000-000000P04
05	455 - 460	37	625	XBDROY-00-0000-000000R05
		36	600	XBDROY-00-0000-000000Q05
		35	575	XBDROY-00-0000-000000P05
		34	550	XBDROY-00-0000-000000N05
06	460 - 465	37	625	XBDROY-00-0000-000000R06
		36	600	XBDROY-00-0000-000000Q06
		35	575	XBDROY-00-0000-000000P06
07	452.5 - 457.5	38	650	XBDROY-00-0000-000000S07
		37	625	XBDROY-00-0000-000000R07
		36	600	XBDROY-00-0000-000000Q07
08	457.5 - 462.5	37	625	XBDROY-00-0000-000000R08
		36	600	XBDROY-00-0000-000000Q08
		35	575	XBDROY-00-0000-000000P08

Notes:

- For additional order codes NOT recommended for new designs please see the Appendix section starting on page 40 .
- XLamp XB-D LED order codes specify only a minimum flux bin and not a maximum. Cree LED may ship reels in flux bins higher than the minimum specified by the order code without advance notice. Shipments will always adhere to the chromaticity or DWL bin restrictions specified by the order code.

ORDER CODES SUGGESTED FOR NEW DESIGNS - COLOR (T_j = 25 °C) - CONTINUED

Royal Blue		Minimum Radiant Flux (mW) @ 350 mA		Order Codes
Kit	Dominant Wavelength (nm)	Code	Flux (mW)	
09	452.5 - 462.5	38	650	XBDR0Y-00-0000-000000S09
		37	625	XBDR0Y-00-0000-000000R09
		36	600	XBDR0Y-00-0000-000000Q09

Blue		Minimum Luminous Flux (lm) @ 350 mA		Order Codes
Kit	Dominant Wavelength (nm)	Code	Flux (lm)	
01	465 - 485	N2	51.7	XBDBLU-00-0000-000000401
		M3	45.7	XBDBLU-00-0000-000000301
		M2	39.8	XBDBLU-00-0000-000000201
		K3	35.2	XBDBLU-00-0000-000000Z01
02	465 - 480	N2	51.7	XBDBLU-00-0000-000000402
		M3	45.7	XBDBLU-00-0000-000000302
		M2	39.8	XBDBLU-00-0000-000000202
		K3	35.2	XBDBLU-00-0000-000000Z02
05	470 - 480	N2	51.7	XBDBLU-00-0000-000000405
		M3	45.7	XBDBLU-00-0000-000000305
		M2	39.8	XBDBLU-00-0000-000000205
		K3	35.2	XBDBLU-00-0000-000000Z05

Green		Minimum Luminous Flux (lm) @ 350 mA		Order Codes
Kit	Dominant Wavelength (nm)	Code	Flux (lm)	
01	520 - 535	R5	139	XBDGRN-00-0000-000000H01
		R4	130	XBDGRN-00-0000-000000G01
		R3	120	XBDGRN-00-0000-000000F01
		R2	114	XBDGRN-00-0000-000000E01
		Q5	107	XBDGRN-00-0000-000000D01
02	520 - 530	R5	139	XBDGRN-00-0000-000000H02
		R4	130	XBDGRN-00-0000-000000G02
		R3	120	XBDGRN-00-0000-000000F02
		R2	114	XBDGRN-00-0000-000000E02
		Q5	107	XBDGRN-00-0000-000000D02

Notes:

- For additional order codes NOT recommended for new designs please see the Appendix section starting on page 40 .
- XLamp XB-D LED order codes specify only a minimum flux bin and not a maximum. Cree LED may ship reels in flux bins higher than the minimum specified by the order code without advance notice. Shipments will always adhere to the chromaticity or DWL bin restrictions specified by the order code.

ORDER CODES SUGGESTED FOR NEW DESIGNS - COLOR (T_j = 25 °C) - CONTINUED

Green		Minimum Luminous Flux (lm) @ 350 mA		Order Codes
Kit	Dominant Wavelength (nm)	Code	Flux (lm)	
03	525 - 535	R5	139	XBDGRN-00-0000-000000H03
		R4	130	XBDGRN-00-0000-000000G03
		R3	120	XBDGRN-00-0000-000000F03
		R2	114	XBDGRN-00-0000-000000E03
		Q5	107	XBDGRN-00-0000-000000D03

PC Amber		Minimum Luminous Flux (lm) @ 350 mA		Order Codes
Kit	Color Bin	Group	Flux (lm)	
01	Y2	Q4	100	XBDBPA-00-0000-000000C01
		Q3	93.9	XBDBPA-00-0000-000000B01
		Q2	87.4	XBDBPA-00-0000-000000A01

Amber		Minimum Luminous Flux (lm) @ 350 mA		Order Codes
Kit	Dominant Wavelength (nm)	Code	Flux (lm)	
01	585 - 595	Q2	87.4	XBDAMB-00-0000-000000A01
		P4	80.6	XBDAMB-00-0000-000000901
		P3	73.9	XBDAMB-00-0000-000000801
		P2	67.2	XBDAMB-00-0000-000000701
03	590 - 595	Q2	87.4	XBDAMB-00-0000-000000A03
		P4	80.6	XBDAMB-00-0000-000000903
		P3	73.9	XBDAMB-00-0000-000000803
		P2	67.2	XBDAMB-00-0000-000000703

Notes:

- For additional order codes NOT recommended for new designs please see the Appendix section starting on page 40 .
- XLamp XB-D LED order codes specify only a minimum flux bin and not a maximum. Cree LED may ship reels in flux bins higher than the minimum specified by the order code without advance notice. Shipments will always adhere to the chromaticity or DWL bin restrictions specified by the order code.

ORDER CODES SUGGESTED FOR NEW DESIGNS - COLOR (T_j = 25 °C) - CONTINUED

Red-Orange		Minimum Luminous Flux (lm) @ 350 mA		Order Codes
Kit	Dominant Wavelength (nm)	Code	Flux (lm)	
01	610 - 620	R2	114	XBDRDO-00-0000-000000E01
		Q5	107	XBDRDO-00-0000-000000D01
		Q4	100	XBDRDO-00-0000-000000C01
		Q3	93.9	XBDRDO-00-0000-000000B01
		Q2	87.4	XBDRDO-00-0000-000000A01
02	610 - 615	R2	114	XBDRDO-00-0000-000000E02
		Q5	107	XBDRDO-00-0000-000000D02
		Q4	100	XBDRDO-00-0000-000000C02
		Q3	93.9	XBDRDO-00-0000-000000B02
		Q2	87.4	XBDRDO-00-0000-000000A02
03	615 - 620	Q4	100	XBDRDO-00-0000-000000C03
		Q3	93.9	XBDRDO-00-0000-000000B03
		Q2	87.4	XBDRDO-00-0000-000000A03

Red		Minimum Luminous Flux (lm) @ 350 mA		Order Codes
Kit	Dominant Wavelength (nm)	Code	Flux (lm)	
01	620 - 630	P4	80.6	XBDRED-00-0000-000000901
		P3	73.9	XBDRED-00-0000-000000801
		P2	67.2	XBDRED-00-0000-000000701
02	620 - 625	P4	80.6	XBDRED-00-0000-000000902
		P3	73.9	XBDRED-00-0000-000000802
		P2	67.2	XBDRED-00-0000-000000702

Notes:

- For additional order codes NOT recommended for new designs please see the Appendix section starting on page 40 .
- XLamp XB-D LED order codes specify only a minimum flux bin and not a maximum. Cree LED may ship reels in flux bins higher than the minimum specified by the order code without advance notice. Shipments will always adhere to the chromaticity or DWL bin restrictions specified by the order code.

RELATIVE SPECTRAL POWER DISTRIBUTION

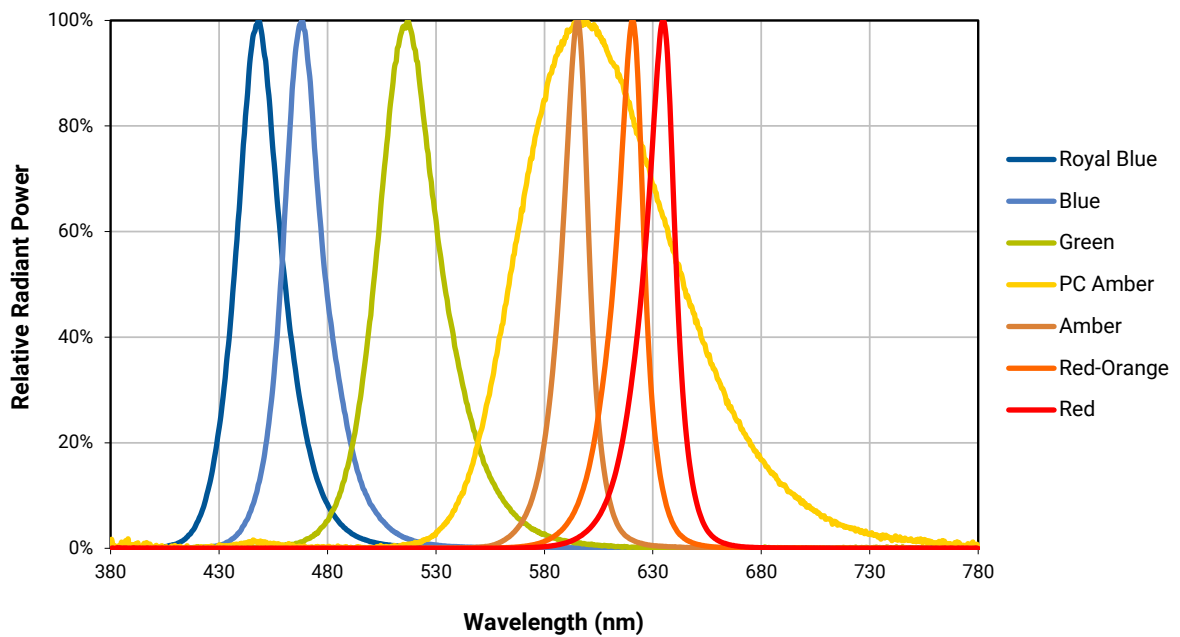
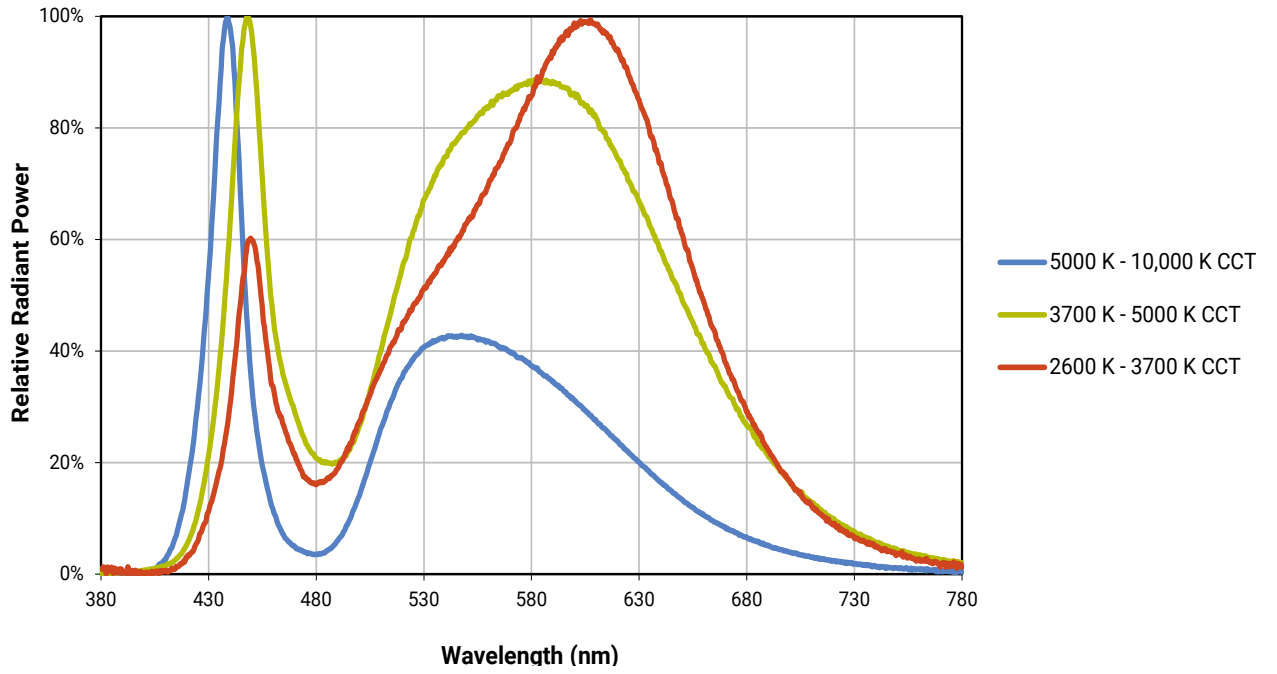

RELATIVE FLUX VS. JUNCTION TEMPERATURE ($I_f = 350 \text{ mA}$)

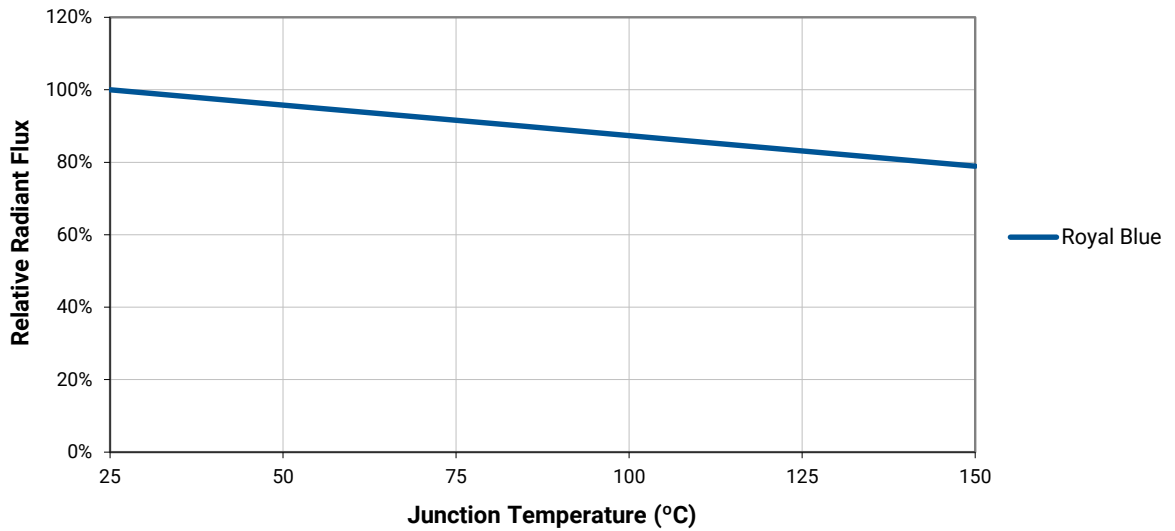
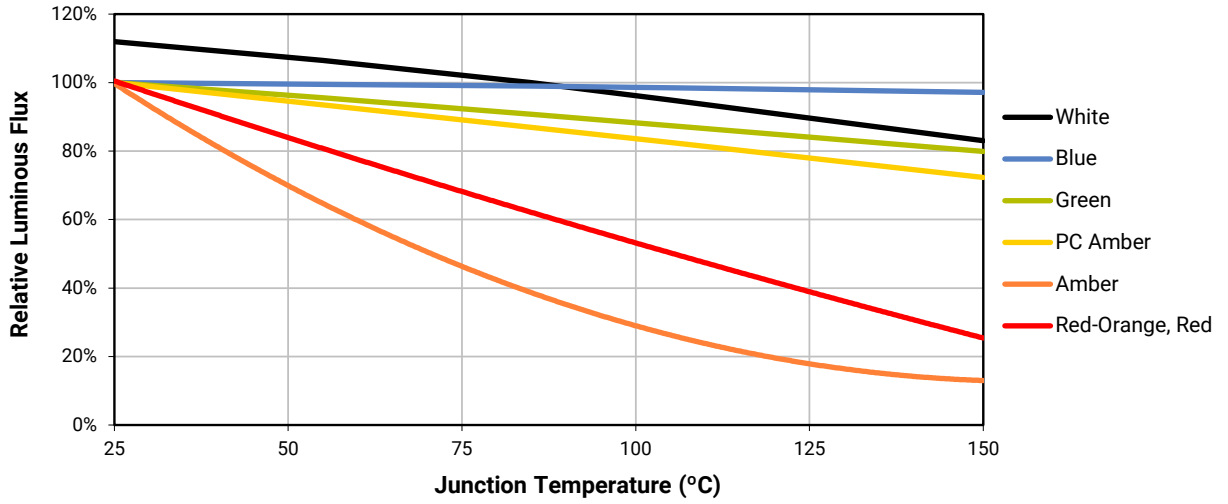

ELECTRICAL CHARACTERISTICS - WHITE ($T_j = 85\text{ }^\circ\text{C}$)

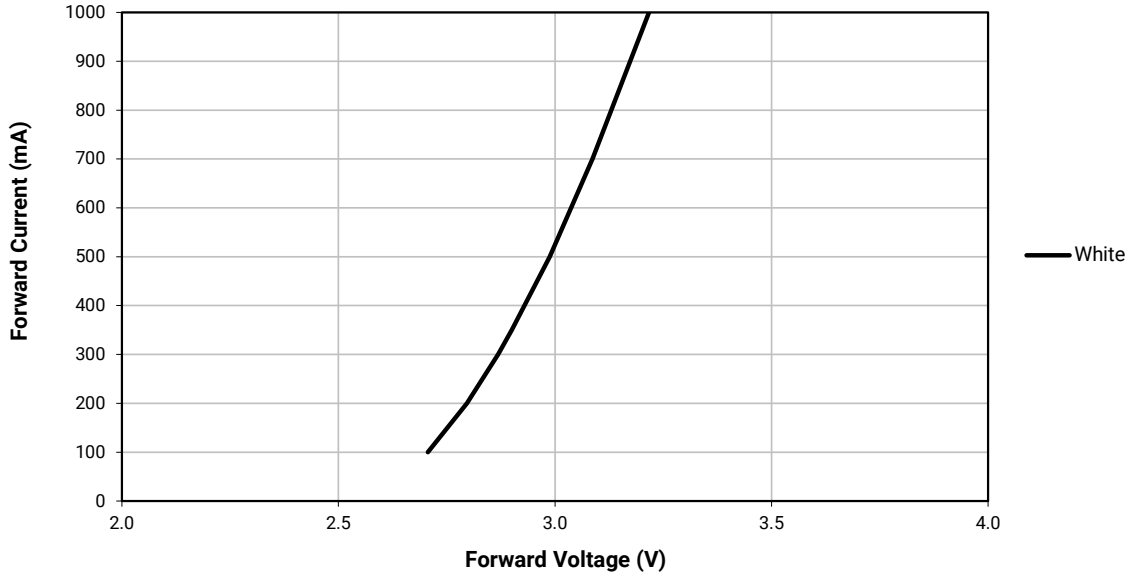

ELECTRICAL CHARACTERISTICS - COLOR ($T_j = 25\text{ }^\circ\text{C}$)

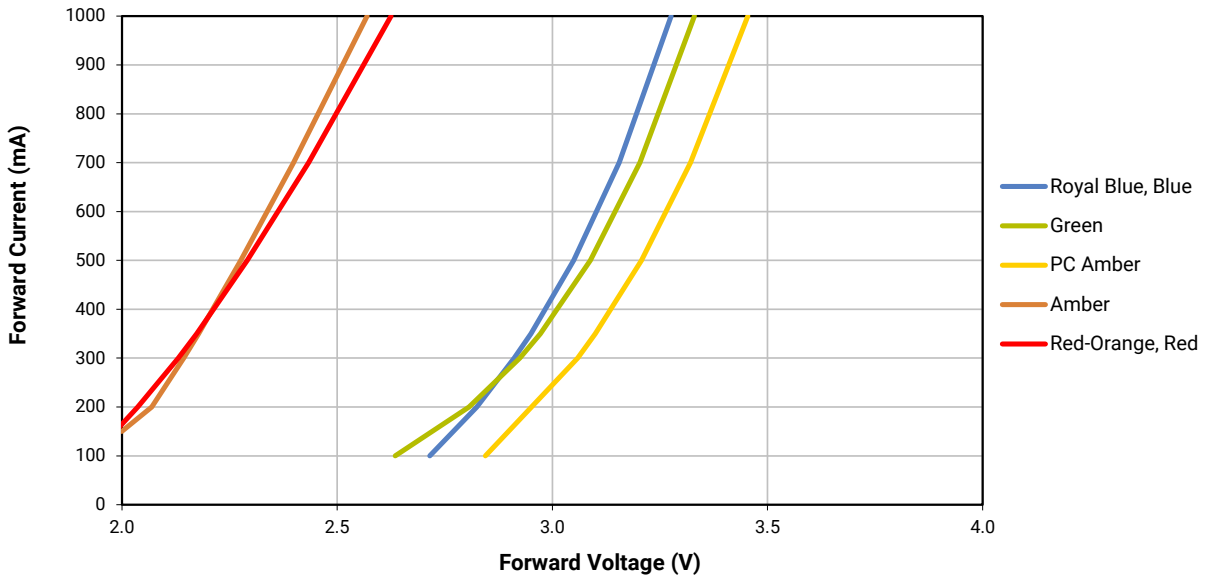

RELATIVE FLUX VS. CURRENT - WHITE ($T_j = 85\text{ }^\circ\text{C}$)

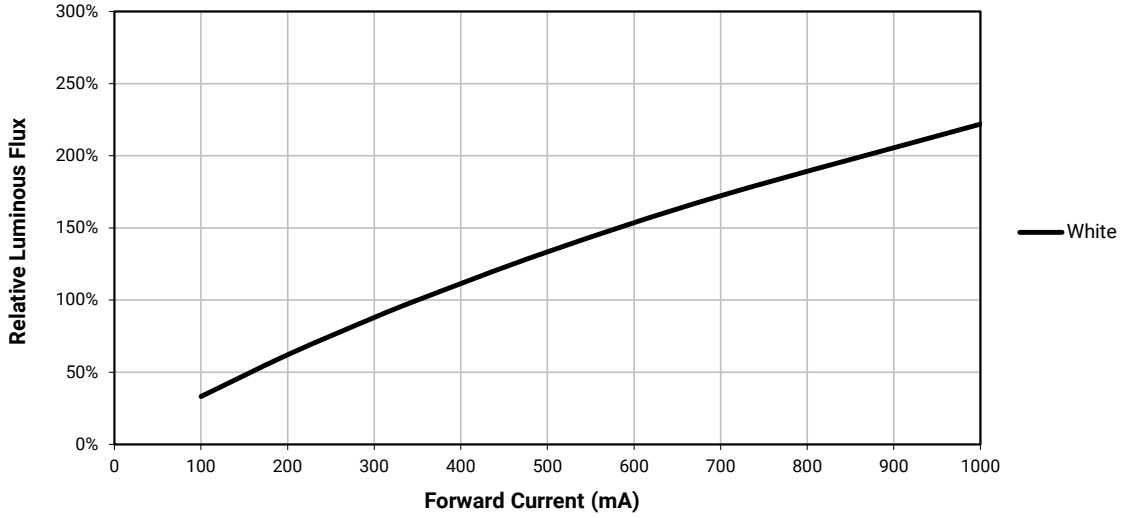

RELATIVE FLUX VS. CURRENT - COLOR ($T_j = 25\text{ }^\circ\text{C}$)

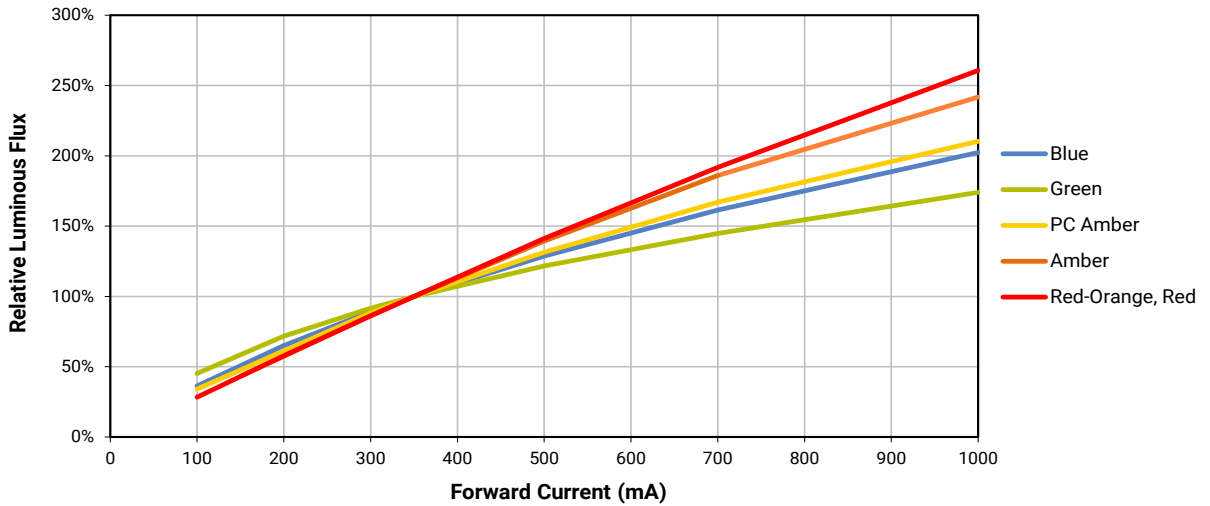

RELATIVE FLUX VS. CURRENT -COLOR ($T_J = 25\text{ }^\circ\text{C}$) - CONTINUED

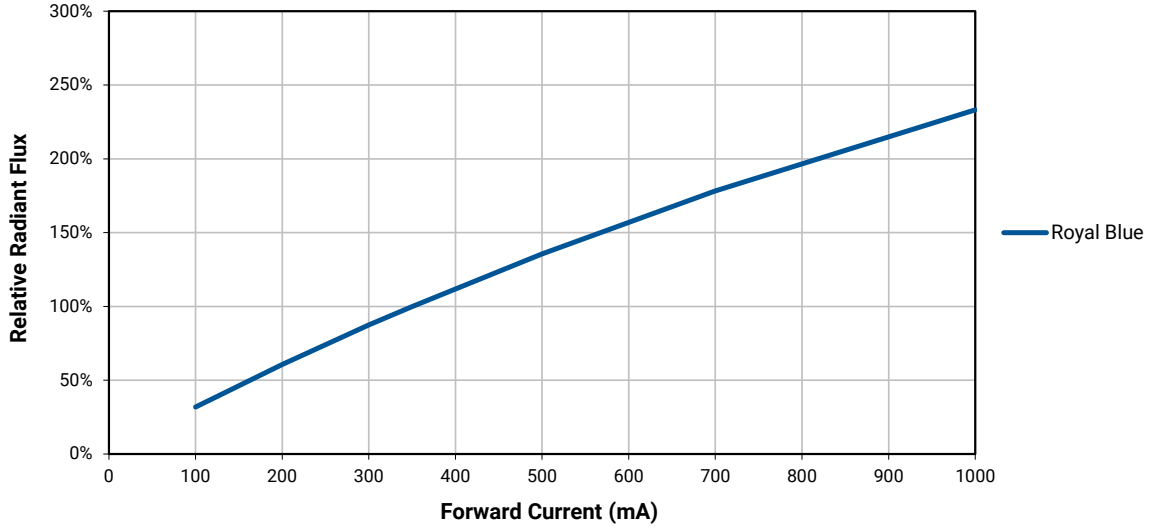

RELATIVE CHROMATICITY VS. CURRENT (WARM WHITE)

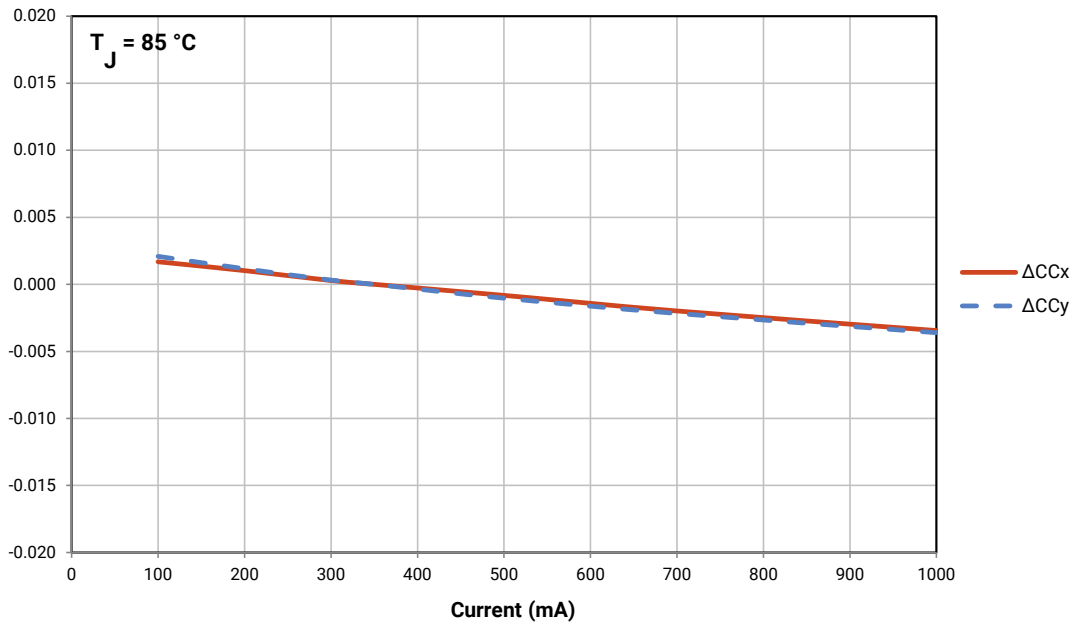

RELATIVE CHROMATICITY VS. TEMPERATURE (WARM WHITE)

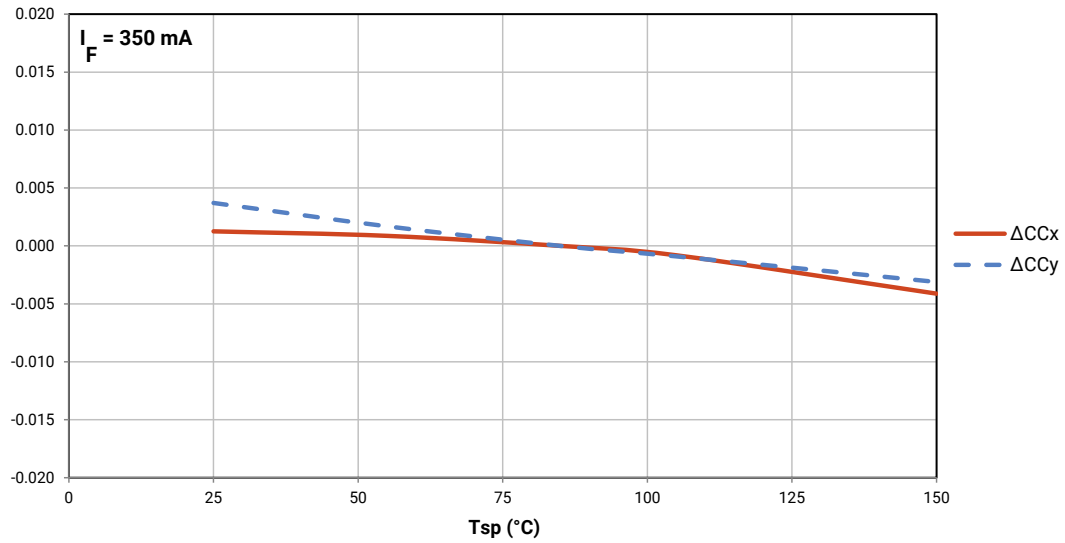

TYPICAL SPATIAL DISTRIBUTION

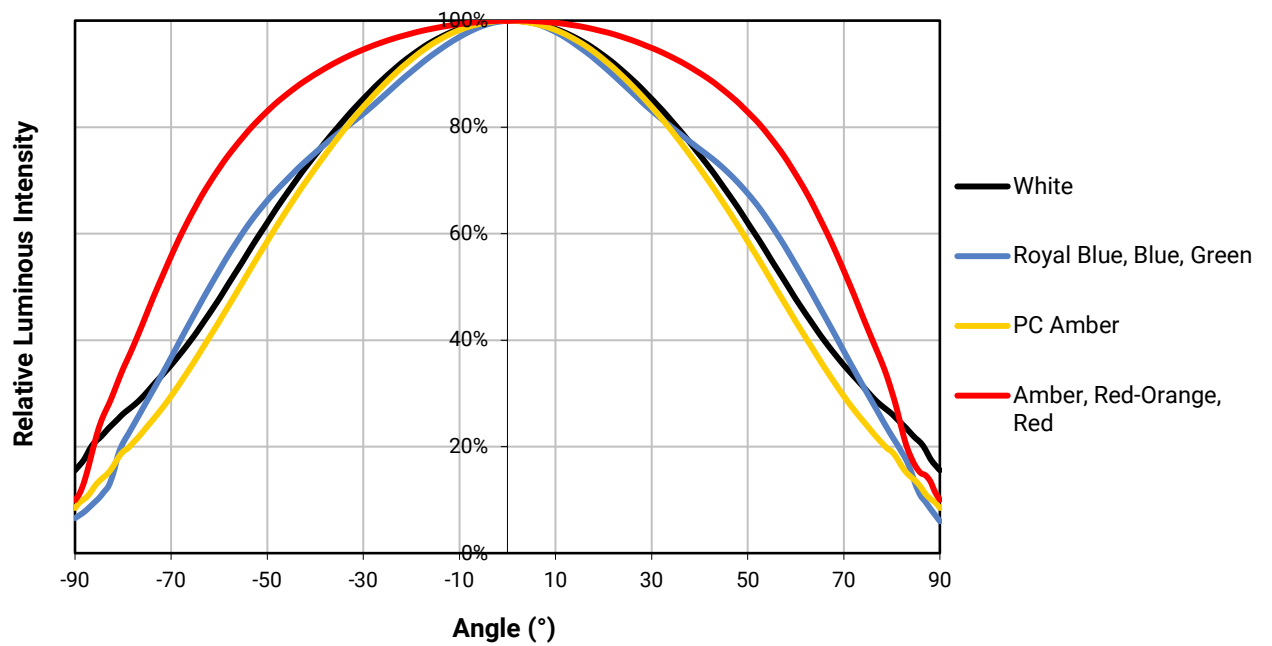

THERMAL DESIGN

The maximum forward current is determined by the thermal resistance between the LED junction and ambient. It is crucial for the end product to be designed in a manner that minimizes the thermal resistance from the solder point to ambient in order to optimize lamp life and optical characteristics.

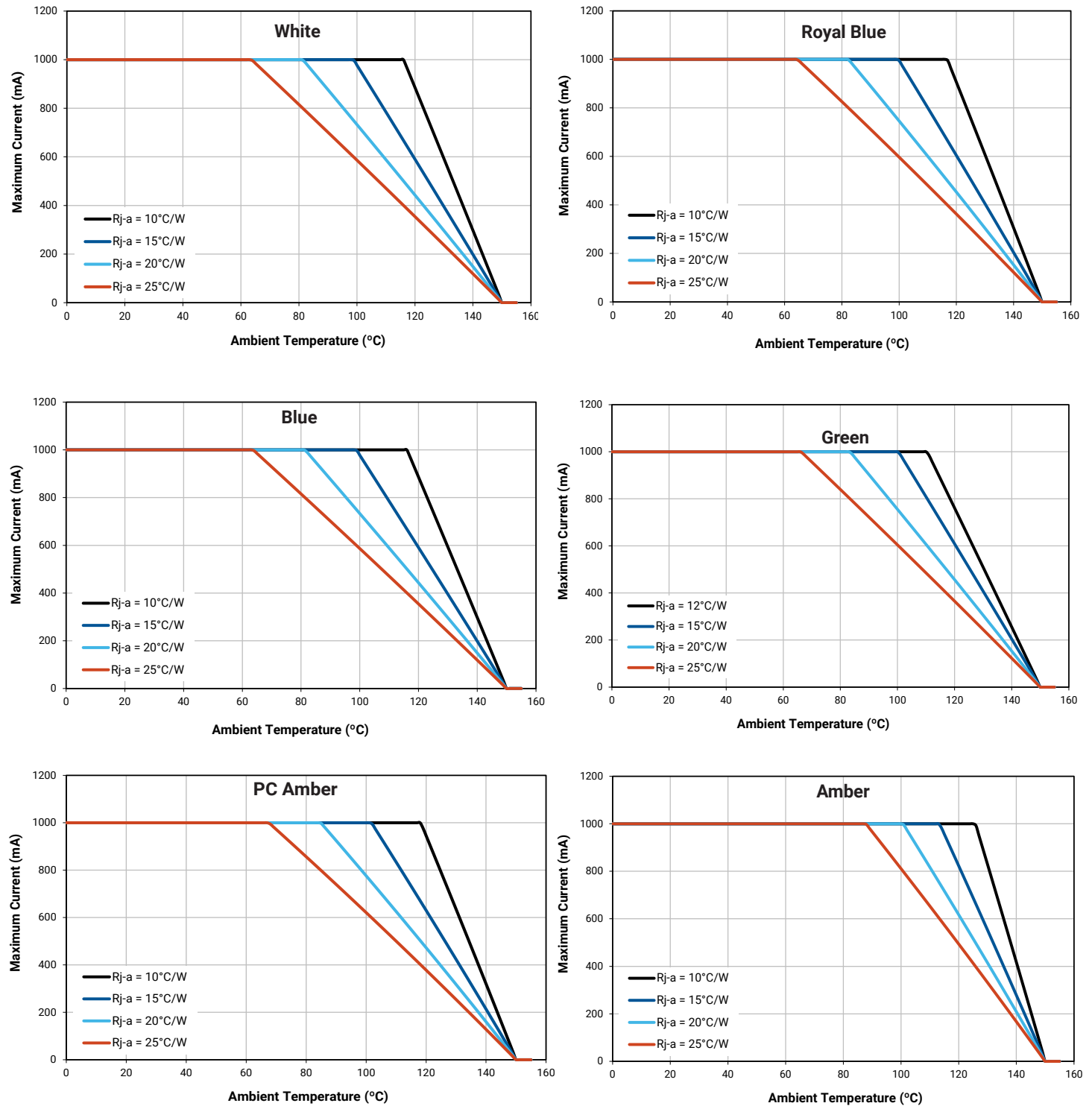

THERMAL DESIGN - CONTINUED

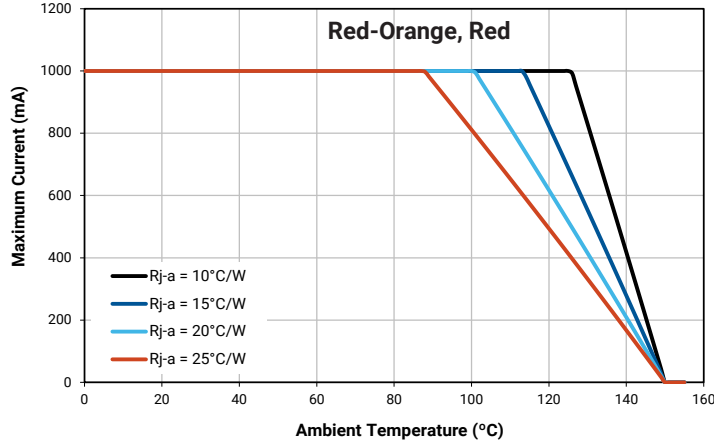

PERFORMANCE GROUPS – LUMINOUS FLUX

XLamp XB-D LEDs, except royal blue, are tested for luminous flux and placed into one of the following luminous-flux groups. These groups, appended with a 0, are used in the Bin Code “Luminous or radiant flux group.”

Group Code	Minimum Luminous Flux (lm) @ 350 mA	Maximum Luminous Flux (lm) @ 350 mA
K2	30.6	35.2
K3	35.2	39.8
M2	39.8	45.7
M3	45.7	51.7
N2	51.7	56.8
N3	56.8	62
N4	62	67.2
P2	67.2	73.9
P3	73.9	80.6
P4	80.6	87.4
Q2	87.4	93.9
Q3	93.9	100
Q4	100	107
Q5	107	114
R2	114	122
R3	122	130
R4	130	139
R5	139	148
S2	148	156
S3	156	164

PERFORMANCE GROUPS – RADIANT FLUX

Royal blue XLamp XB-D LEDs are tested for radiant flux and sorted into one of the following radiant-flux bins.

Group	Minimum Radiant Flux (mW) @ 350 mA	Maximum Radiant Flux (mW) @ 350 mA
34	550	575
35	575	600
36	600	625
37	625	650
38	650	675
39	675	700
40	700	725

PERFORMANCE GROUPS – DOMINANT WAVELENGTH

Color XLamp XB-D LEDs are tested for dominant wavelength (DWL) and sorted into one of the DWL bins defined below.

Color	DWL Group	Minimum DWL (nm) @ 350 mA	Maximum DWL (nm) @ 350 mA
Royal Blue	D36	450	452.5
	D37	452.5	455
	D46	455	457.5
	D47	457.5	460
	D56	460	462.5
	D57	462.5	465
Blue	B3	465	470
	B4	470	475
	B5	475	480
	B6	480	485
Green	G2	520	525
	G3	525	530
	G4	530	535
Amber	A2	585	590
	A3	590	595
Red-Orange	O3	610	615
	O4	615	620
Red	R2	620	625
	R3	625	630

PERFORMANCE GROUPS – FORWARD VOLTAGE

Amber, red-orange, red and royal blue XLamp XB-D LEDs are tested for forward voltage and sorted into one of the forward voltage bins defined below.

Forward Voltage Group	Minimum Forward Voltage (V) @ 350 mA	Maximum Forward Voltage (V) @ 350 mA
B	1.75	2.0
C	2.0	2.25
D	2.25	2.5
E	2.5	2.75
F	2.75	3.0
G	3.0	3.25
H	3.25	3.5

PERFORMANCE GROUPS – CHROMATICITY

Region	x	y	Region	x	y	Region	x	y	Region	x	y
0A	0.2950	0.2970	0B	0.2920	0.3060	0C	0.2984	0.3133	0D	0.2984	0.3133
	0.2920	0.3060		0.2895	0.3135		0.2962	0.3220		0.3048	0.3207
	0.2984	0.3133		0.2962	0.3220		0.3028	0.3304		0.3068	0.3113
	0.3009	0.3042		0.2984	0.3133		0.3048	0.3207		0.3009	0.3042
0R	0.2980	0.2880	0S	0.2895	0.3135	0T	0.2962	0.3220	0U	0.3037	0.2937
	0.2950	0.2970		0.2870	0.3210		0.2937	0.3312		0.3009	0.3042
	0.3009	0.3042		0.2937	0.3312		0.3005	0.3415		0.3068	0.3113
	0.3037	0.2937		0.2962	0.3220		0.3028	0.3304		0.3093	0.2993
1A	0.3048	0.3207	1B	0.3028	0.3304	1C	0.3115	0.3391	1D	0.3130	0.3290
	0.3130	0.3290		0.3115	0.3391		0.3205	0.3481		0.3213	0.3373
	0.3144	0.3186		0.3130	0.3290		0.3213	0.3373		0.3221	0.3261
	0.3068	0.3113		0.3048	0.3207		0.3130	0.3290		0.3144	0.3186
1R	0.3068	0.3113	1S	0.3005	0.3415	1T	0.3099	0.3509	1U	0.3144	0.3186
	0.3144	0.3186		0.3099	0.3509		0.3196	0.3602		0.3221	0.3261
	0.3161	0.3059		0.3115	0.3391		0.3205	0.3481		0.3231	0.3120
	0.3093	0.2993		0.3028	0.3304		0.3115	0.3391		0.3161	0.3059
2A	0.3215	0.3350	2B	0.3207	0.3462	2C	0.3290	0.3538	2D	0.3290	0.3417
	0.3290	0.3417		0.3290	0.3538		0.3376	0.3616		0.3371	0.3490
	0.3290	0.3300		0.3290	0.3417		0.3371	0.3490		0.3366	0.3369
	0.3222	0.3243		0.3215	0.3350		0.3290	0.3417		0.3290	0.3300
2R	0.3222	0.3243	2S	0.3196	0.3602	2T	0.3290	0.3690	2U	0.3290	0.3300
	0.3290	0.3300		0.3290	0.3690		0.3381	0.3762		0.3366	0.3369
	0.3290	0.3180		0.3290	0.3538		0.3376	0.3616		0.3361	0.3245
	0.3231	0.3120		0.3207	0.3462		0.3290	0.3538		0.3290	0.3180

PERFORMANCE GROUPS – CHROMATICITY (CONTINUED)

Region	x	y	Region	x	y	Region	x	y	Region	x	y
3A	0.3371	0.3490	3B	0.3376	0.3616	3C	0.3463	0.3687	3D	0.3451	0.3554
	0.3451	0.3554		0.3463	0.3687		0.3551	0.3760		0.3533	0.3620
	0.3440	0.3427		0.3451	0.3554		0.3533	0.3620		0.3515	0.3487
	0.3366	0.3369		0.3371	0.3490		0.3451	0.3554		0.3440	0.3427
3R	0.3366	0.3369	3S	0.3381	0.3762						
	0.3440	0.3428		0.3480	0.3840						
	0.3429	0.3307		0.3463	0.3687						
	0.3361	0.3245		0.3376	0.3616						
4A	0.3530	0.3597	4B	0.3548	0.3736	4C	0.3641	0.3804	4D	0.3615	0.3659
	0.3615	0.3659		0.3641	0.3804		0.3736	0.3874		0.3702	0.3722
	0.3590	0.3521		0.3615	0.3659		0.3702	0.3722		0.3670	0.3578
	0.3512	0.3465		0.3530	0.3597		0.3615	0.3659		0.3590	0.3521
4R	0.3512	0.3465	4S	0.3571	0.3907	4T	0.3668	0.3957	4U	0.3590	0.3521
	0.3590	0.3521		0.3668	0.3957		0.3771	0.4034		0.3670	0.3578
	0.3567	0.3389		0.3641	0.3804		0.3736	0.3874		0.3640	0.3440
	0.3495	0.3339		0.3548	0.3736		0.3641	0.3804		0.3567	0.3389
5A1	0.3670	0.3578	5A2	0.3686	0.3649	5A3	0.3744	0.3685	5A4	0.3726	0.3612
	0.3686	0.3649		0.3702	0.3722		0.3763	0.3760		0.3744	0.3685
	0.3744	0.3685		0.3763	0.3760		0.3825	0.3798		0.3804	0.3721
	0.3726	0.3612		0.3744	0.3685		0.3804	0.3721		0.3783	0.3646
5B1	0.3702	0.3722	5B2	0.3719	0.3797	5B3	0.3782	0.3837	5B4	0.3763	0.3760
	0.3719	0.3797		0.3736	0.3874		0.3802	0.3916		0.3782	0.3837
	0.3782	0.3837		0.3802	0.3916		0.3869	0.3958		0.3847	0.3877
	0.3763	0.3760		0.3782	0.3837		0.3847	0.3877		0.3825	0.3798
5C1	0.3825	0.3798	5C2	0.3847	0.3877	5C3	0.3912	0.3917	5C4	0.3887	0.3836
	0.3847	0.3877		0.3869	0.3958		0.3937	0.4001		0.3912	0.3917
	0.3912	0.3917		0.3937	0.4001		0.4006	0.4044		0.3978	0.3958
	0.3887	0.3836		0.3912	0.3917		0.3978	0.3958		0.3950	0.3875
5D1	0.3783	0.3646	5D2	0.3804	0.3721	5D3	0.3863	0.3758	5D4	0.3840	0.3681
	0.3804	0.3721		0.3825	0.3798		0.3887	0.3836		0.3863	0.3758
	0.3863	0.3758		0.3887	0.3836		0.3950	0.3875		0.3924	0.3794
	0.3840	0.3681		0.3863	0.3758		0.3924	0.3794		0.3898	0.3716
5R	0.3670	0.3578	5S	0.3771	0.4034	5T	0.3916	0.4127	5U	0.3783	0.3646
	0.3783	0.3646		0.3916	0.4127		0.4064	0.4221		0.3898	0.3716
	0.3743	0.3502		0.3869	0.3958		0.4006	0.4044		0.3848	0.3565
	0.3640	0.3440		0.3736	0.3874		0.3869	0.3958		0.3743	0.3502
6A1	0.3889	0.3690	6A2	0.3915	0.3768	6A3	0.3981	0.3800	6A4	0.3953	0.3720
	0.3915	0.3768		0.3941	0.3848		0.4010	0.3882		0.3981	0.3800
	0.3981	0.3800		0.4010	0.3882		0.4080	0.3916		0.4048	0.3832
	0.3953	0.3720		0.3981	0.3800		0.4048	0.3832		0.4017	0.3751

PERFORMANCE GROUPS – CHROMATICITY (CONTINUED)

Region	x	y	Region	x	y	Region	x	y	Region	x	y
6B1	0.3941	0.3848	6B2	0.3968	0.3930	6B3	0.4040	0.3966	6B4	0.4010	0.3882
	0.3968	0.3930		0.3996	0.4015		0.4071	0.4052		0.4040	0.3966
	0.4040	0.3966		0.4071	0.4052		0.4146	0.4089		0.4113	0.4001
	0.4010	0.3882		0.4040	0.3966		0.4113	0.4001		0.4080	0.3916
6C1	0.4080	0.3916	6C2	0.4113	0.4001	6C3	0.4186	0.4037	6C4	0.4150	0.3950
	0.4113	0.4001		0.4146	0.4089		0.4222	0.4127		0.4186	0.4037
	0.4186	0.4037		0.4222	0.4127		0.4299	0.4165		0.4259	0.4073
	0.4150	0.3950		0.4186	0.4037		0.4259	0.4073		0.4221	0.3984
6D1	0.4017	0.3751	6D2	0.4048	0.3832	6D3	0.4116	0.3865	6D4	0.4082	0.3782
	0.4048	0.3832		0.4080	0.3916		0.4150	0.3950		0.4116	0.3865
	0.4116	0.3865		0.4150	0.3950		0.4221	0.3984		0.4183	0.3898
	0.4082	0.3782		0.4116	0.3865		0.4183	0.3898		0.4147	0.3814
6R	0.3889	0.3690	6S	0.4054	0.4191	6T	0.4217	0.4273	6U	0.4017	0.3751
	0.4017	0.3751		0.4217	0.4273		0.4382	0.4356		0.4147	0.3814
	0.3957	0.3596		0.4146	0.4089		0.4299	0.4165		0.4077	0.3652
	0.3840	0.3540		0.3996	0.4015		0.4146	0.4089		0.3957	0.3596
7A	0.4221	0.3985	7B	0.4299	0.4165	7C	0.4430	0.4212	7D	0.4342	0.4028
	0.4342	0.4028		0.4430	0.4212		0.4562	0.426		0.4465	0.4071
	0.4260	0.3853		0.4342	0.4028		0.4465	0.4071		0.4373	0.3893
	0.4147	0.3814		0.4221	0.3985		0.4342	0.4028		0.4260	0.3853
7A1	0.4147	0.3814	7A2	0.4183	0.3898	7A3	0.4242	0.3919	7A4	0.4203	0.3833
	0.4183	0.3898		0.4221	0.3984		0.4281	0.4006		0.4242	0.3919
	0.4242	0.3919		0.4281	0.4006		0.4342	0.4028		0.4300	0.3939
	0.4203	0.3833		0.4242	0.3919		0.4300	0.3939		0.4259	0.3853
7B1	0.4221	0.3984	7B2	0.4259	0.4073	7B3	0.4322	0.4096	7B4	0.4281	0.4006
	0.4259	0.4073		0.4299	0.4165		0.4364	0.4188		0.4322	0.4096
	0.4322	0.4096		0.4364	0.4188		0.4430	0.4212		0.4385	0.4119
	0.4281	0.4006		0.4322	0.4096		0.4385	0.4119		0.4342	0.4028
7C1	0.4342	0.4028	7C2	0.4385	0.4119	7C3	0.4449	0.4141	7C4	0.4403	0.4049
	0.4385	0.4119		0.4430	0.4212		0.4496	0.4236		0.4449	0.4141
	0.4449	0.4141		0.4496	0.4236		0.4562	0.4260		0.4513	0.4164
	0.4403	0.4049		0.4449	0.4141		0.4513	0.4164		0.4465	0.4071
7D1	0.4259	0.3853	7D2	0.4300	0.3939	7D3	0.4359	0.3960	7D4	0.4316	0.3873
	0.4300	0.3939		0.4342	0.4028		0.4403	0.4049		0.4359	0.3960
	0.4359	0.3960		0.4403	0.4049		0.4465	0.4071		0.4418	0.3981
	0.4316	0.3873		0.4359	0.3960		0.4418	0.3981		0.4373	0.3893
8A	0.4465	0.4071	8B	0.4562	0.4260	8C	0.4687	0.4289	8D	0.4582	0.4099
	0.4582	0.4099		0.4687	0.4289		0.4813	0.4319		0.4700	0.4126
	0.4483	0.3918		0.4582	0.4099		0.4700	0.4126		0.4593	0.3944
	0.4373	0.3893		0.4465	0.4071		0.4582	0.4099		0.4483	0.3918

PERFORMANCE GROUPS – CHROMATICITY (CONTINUED)

Region	x	y	Region	x	y	Region	x	y	Region	x	y
8A1	0.4373	0.3893	8A2	0.4418	0.3981	8A3	0.4475	0.3994	8A4	0.4428	0.3906
	0.4418	0.3981		0.4465	0.4071		0.4523	0.4085		0.4475	0.3994
	0.4475	0.3994		0.4523	0.4085		0.4582	0.4099		0.4532	0.4008
	0.4428	0.3906		0.4475	0.3994		0.4532	0.4008		0.4483	0.3919
8B1	0.4465	0.4071	8B2	0.4513	0.4164	8B3	0.4573	0.4178	8B4	0.4523	0.4085
	0.4513	0.4164		0.4562	0.4260		0.4624	0.4274		0.4573	0.4178
	0.4573	0.4178		0.4624	0.4274		0.4687	0.4289		0.4634	0.4193
	0.4523	0.4085		0.4573	0.4178		0.4634	0.4193		0.4582	0.4099
8C1	0.4582	0.4099	8C2	0.4634	0.4193	8C3	0.4695	0.4207	8C4	0.4641	0.4112
	0.4634	0.4193		0.4687	0.4289		0.4750	0.4304		0.4695	0.4207
	0.4695	0.4207		0.4750	0.4304		0.4813	0.4319		0.4756	0.4221
	0.4641	0.4112		0.4695	0.4207		0.4756	0.4221		0.4700	0.4126
8D1	0.4483	0.3919	8D2	0.4532	0.4008	8D3	0.4589	0.4021	8D4	0.4538	0.3931
	0.4532	0.4008		0.4582	0.4099		0.4641	0.4112		0.4589	0.4021
	0.4589	0.4021		0.4641	0.4112		0.4700	0.4126		0.4646	0.4034
	0.4538	0.3931		0.4589	0.4021		0.4646	0.4034		0.4593	0.3944

XLamp XB-D PC amber LEDs are placed into the region defined by the following bounding coordinates.

Region	x	y
Y2	0.5469	0.4249
	0.5700	0.4100
	0.5900	0.4100
	0.5610	0.4390

STANDARD COOL WHITE KITS PLOTTED ON ANSI STANDARD CHROMATICITY REGIONS

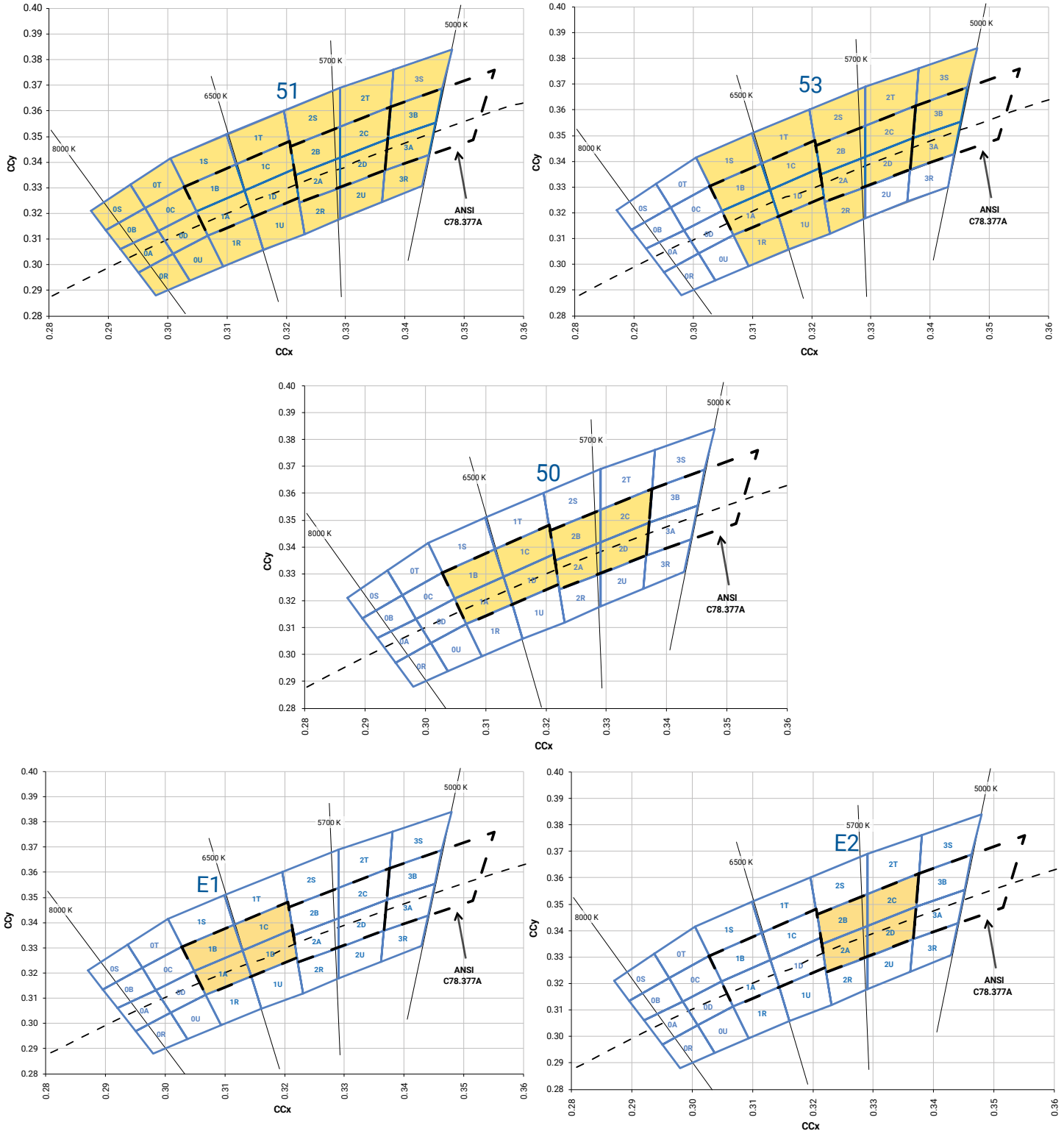

STANDARD WARM AND NEUTRAL WHITE KITS PLOTTED ON ANSI STANDARD CHROMATICITY REGIONS

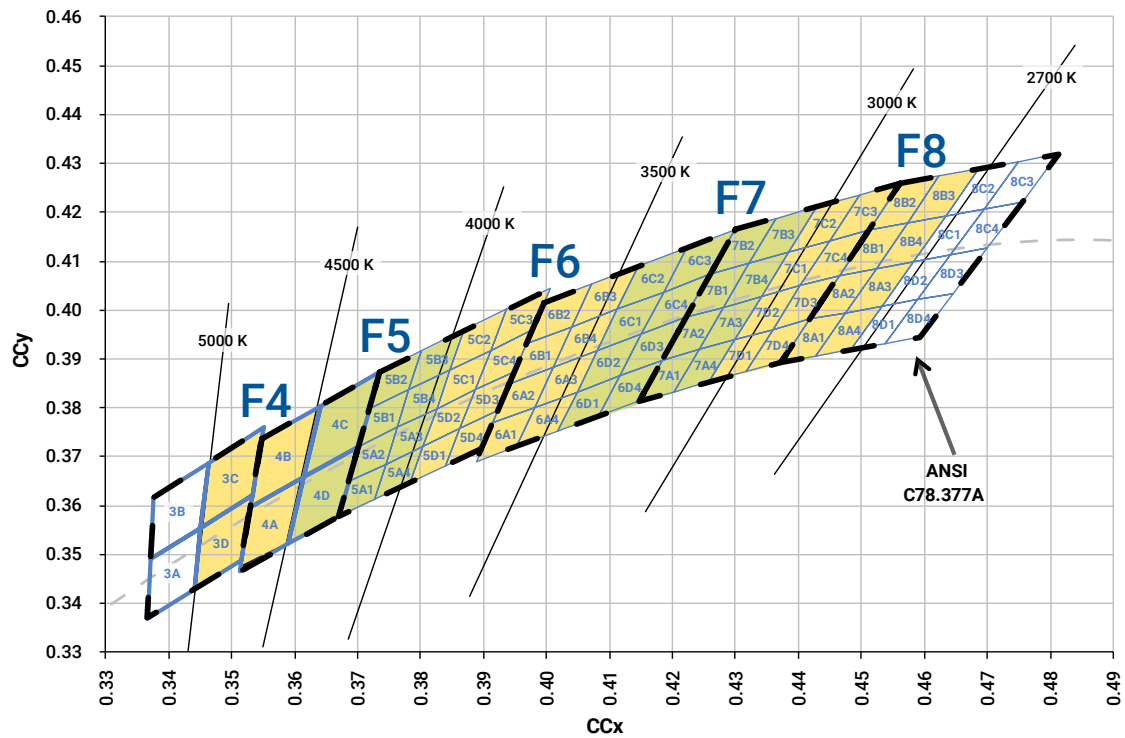
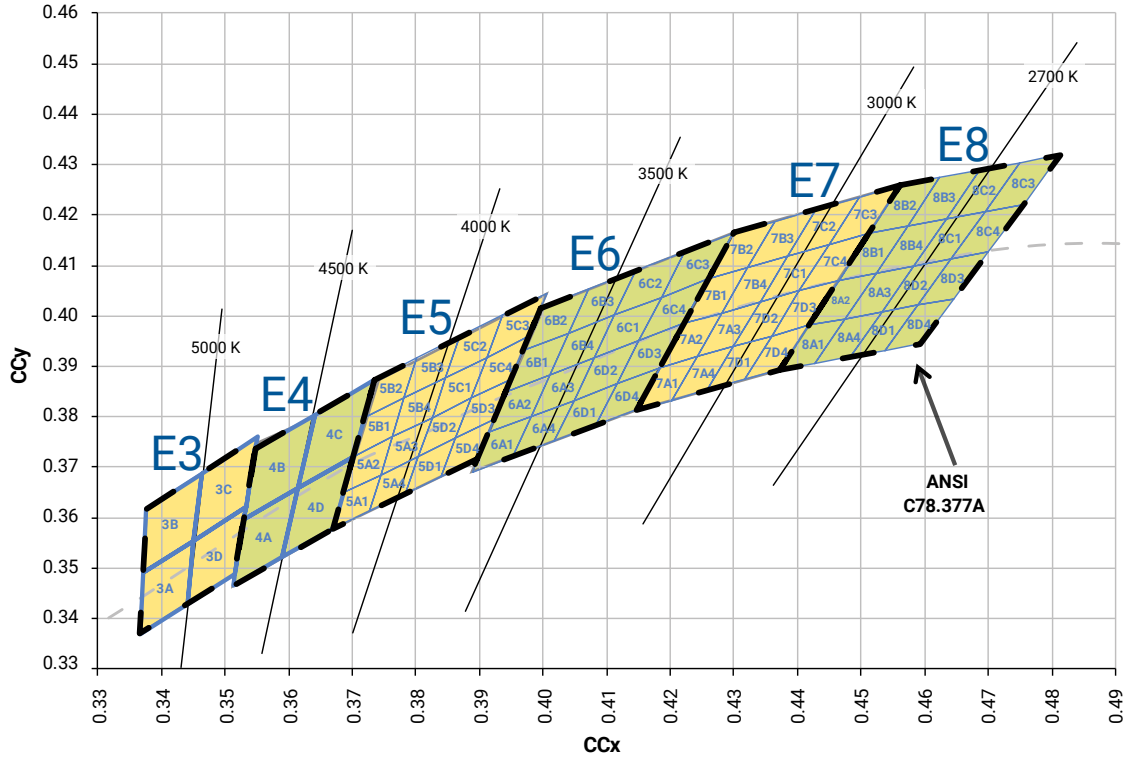

CREE LED'S PC AMBER KIT PLOTTED ON THE 1931 CIE CURVE

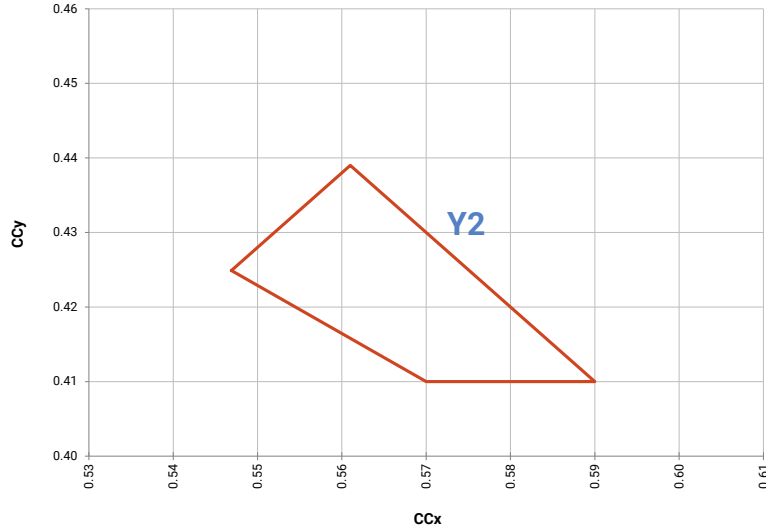

CREE LED'S STANDARD CHROMATICITY KITS

The following table provides the chromaticity bins associated with chromaticity kits, which are specified as part of the order code.

Color	Kit	Chromaticity Bins
Cool White	51	0A, 0B, 0C, 0D, 0R, 0S, 0T, 0U, 1A, 1B, 1C, 1D, 1R, 1S, 1T, 1U, 2A, 2B, 2C, 2D, 2R, 2S, 2T, 2U, 3A, 3B, 3R, 3S
	53	1A, 1B, 1C, 1D, 1R, 1S, 1T, 1U, 2A, 2B, 2C, 2D, 2R, 2S, 2T, 3A, 3B, 3S
	50	1A, 1B, 1C, 1D, 2A, 2B, 2C, 2D
	E1	1A, 1B, 1C, 1D
	E2	2A, 2B, 2C, 2D
Neutral White	E3	3A, 3B, 3C, 3D
	F4	3C, 3D, 4A, 4B
	E4	4A, 4B, 4C, 4D
	F5	4C, 4D, 5A1, 5A2, 5A3, 5A4, 5B1, 5B2, 5B3, 5B4
	E5	5A1, 5A2, 5A3, 5A4, 5B1, 5B2, 5B3, 5B4, 5C1, 5C2, 5C3, 5C4, 5D1, 5D2, 5D3, 5D4
Warm White	F6	5C1, 5C2, 5C3, 5C4, 5D1, 5D2, 5D3, 5D4, 6A1, 6A2, 6A3, 6A4, 6B1, 6B2, 6B3, 6B4
	E6	6A1, 6A2, 6A3, 6A4, 6B1, 6B2, 6B3, 6B4, 6C1, 6C2, 6C3, 6C4, 6D1, 6D2, 6D3, 6D4
	F7	6C1, 6C2, 6C3, 6C4, 6D1, 6D2, 6D3, 6D4, 7A1, 7A2, 7A3, 7A4, 7B1, 7B2, 7B3, 7B4
	E7	7A1, 7A2, 7A3, 7A4, 7B1, 7B2, 7B3, 7B4, 7C1, 7C2, 7C3, 7C4, 7D1, 7D2, 7D3, 7D4
	F8	7C1, 7C2, 7C3, 7C4, 7D1, 7D2, 7D3, 7D4, 8A1, 8A2, 8A3, 8A4, 8B1, 8B2, 8B3, 8B4
	E8	8A1, 8A2, 8A3, 8A4, 8B1, 8B2, 8B3, 8B4, 8C1, 8C2, 8C3, 8C4, 8D1, 8D2, 8D3, 8D4

BIN AND ORDER CODE FORMATS

Bin codes and order codes for XB-D LEDs are configured in the following manner:

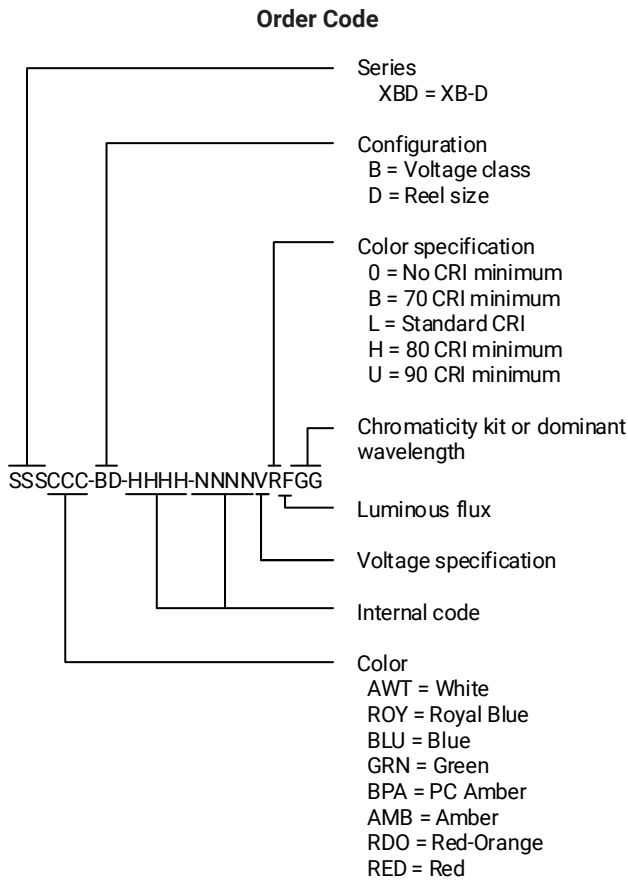

Example Order Code: XBD^{AWT}-00-0000-0000HAE7

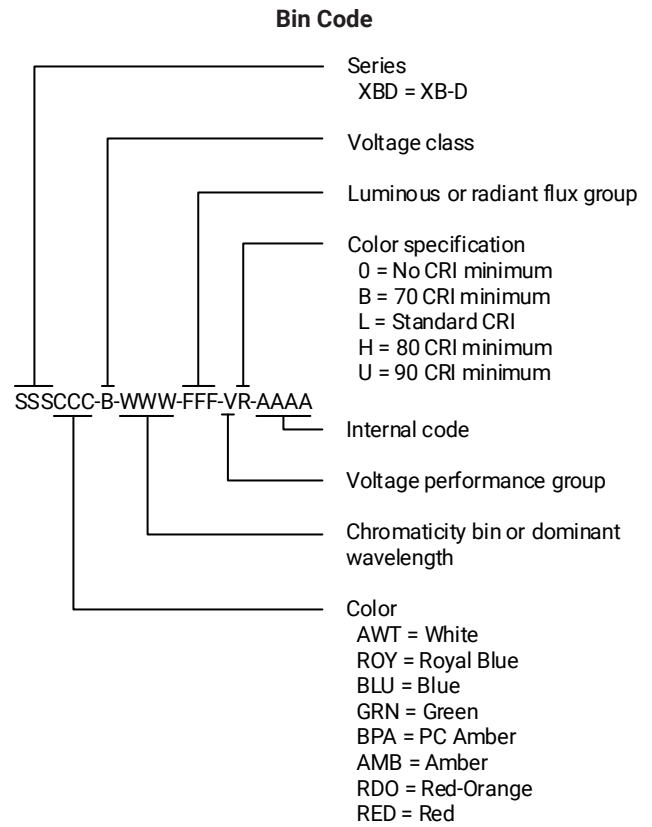

Example Bin Code: XBD^{AWT}-0-7A3-Q20-0H-0001

REFLOW SOLDERING CHARACTERISTICS

In testing, Cree LED has found XLamp XB-D LEDs to be compatible with JEDEC J-STD-020C, using the parameters listed below. As a general guideline, Cree LED recommends that users follow the recommended soldering profile provided by the manufacturer of the solder paste used, and therefore it is the lamp or luminaire manufacturer’s responsibility to determine applicable soldering requirements.

Note that this general guideline may not apply to all PCB designs and configurations of reflow soldering equipment.

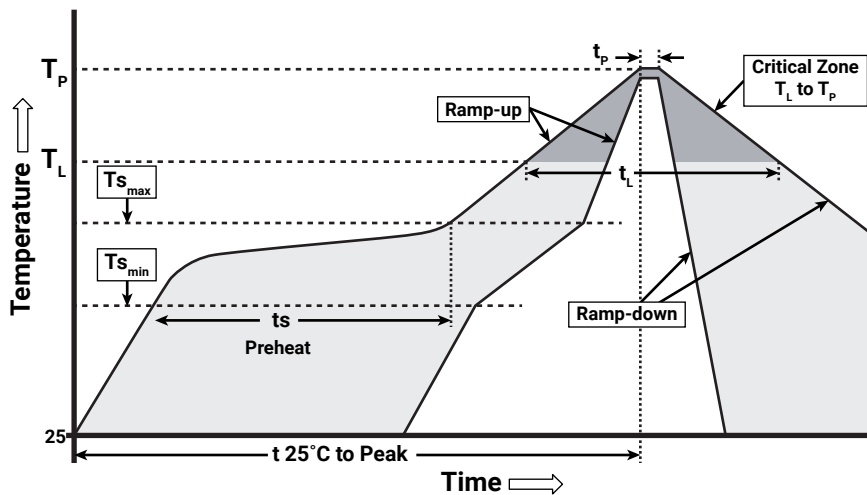

IPC/JEDEC J-STD-020C

Profile Feature	Lead-Free Solder
Average Ramp-Up Rate ($T_{s_{max}}$ to T_p)	1.2 °C/second
Preheat: Temperature Min ($T_{s_{min}}$)	120 °C
Preheat: Temperature Max ($T_{s_{max}}$)	170 °C
Preheat: Time ($t_{s_{min}}$ to $t_{s_{max}}$)	65-150 seconds
Time Maintained Above: Temperature (T_L)	217 °C
Time Maintained Above: Time (t_t)	45-90 seconds
Peak/Classification Temperature (T_p)	235 - 245 °C
Time Within 5 °C of Actual Peak Temperature (t_p)	20-40 seconds
Ramp-Down Rate	1 - 6 °C/second
Time 25 °C to Peak Temperature	4 minutes max.

Note: All temperatures refer to topside of the package, measured on the package body surface.

NOTES

Measurements

The luminous flux, radiant power, chromaticity, forward voltage and CRI measurements in this document are binning specifications only and solely represent product measurements as of the date of shipment. These measurements will change over time based on a number of factors that are not within Cree LED's control and are not intended or provided as operational specifications for the products. Calculated values are provided for informational purposes only and are not intended or provided as specifications.

Pre-Release Qualification Testing

Please read the [LED Reliability Overview](#) for details of the qualification process Cree LED applies to ensure long-term reliability for XLamp LEDs and details of Cree LED's pre-release qualification testing for XLamp LEDs.

Lumen Maintenance

Cree LED now uses standardized IES LM-80-08 and TM-21-11 methods for collecting long-term data and extrapolating LED lumen maintenance. For information on the specific LM-80 data sets available for this LED, refer to the public [LM-80 results document](#).

Please read the [Long-Term Lumen Maintenance application note](#) for more details on Cree LED's lumen maintenance testing and forecasting. Please read the [Thermal Management application note](#) for details on how thermal design, ambient temperature, and drive current affect the LED junction temperature.

Moisture Sensitivity

Cree LED recommends keeping XLamp LEDs in the provided, resealable moisture-barrier packaging (MBP) until immediately prior to soldering. Unopened MBPs that contain XLamp LEDs do not need special storage for moisture sensitivity.

Once the MBP is opened, XLamp XB-D LEDs may be stored as MSL 1 per JEDEC J-STD-033, meaning they have unlimited floor life in conditions of ≤ 30 °C/85% relative humidity (RH). Regardless of storage condition, Cree LED recommends sealing any unsoldered LEDs in the original MBP.

RoHS Compliance

The levels of RoHS restricted materials in this product are below the maximum concentration values (also referred to as the threshold limits) permitted for such substances, or are used in an exempted application, in accordance with EU Directive 2011/65/EC (RoHS2), as implemented January 2, 2013. RoHS Declarations for this product can be obtained from your Cree LED representative or from the [Product Ecology](#) section of the Cree LED website.

REACH Compliance

REACH substances of very high concern (SVHCs) information is available for this product. Since the European Chemical Agency (ECHA) has published notice of their intent to frequently revise the SVHC listing for the foreseeable future, please contact a Cree LED representative to insure you get the most up-to-date REACH SVHC Declaration. REACH banned substance information (REACH Article 67) is also available upon request.

NOTES - CONTINUED

UL® Recognized Component

This product meets the requirements to be considered a UL Recognized Component with Level 4 enclosure consideration. The LED package or a portion thereof has been investigated as a fire and electrical enclosure per ANSI/UL 8750.

Vision Advisory

WARNING: Do not look at an exposed lamp in operation. Eye injury can result. For more information about LEDs and eye safety, please refer to the [LED Eye Safety application note](#).

MECHANICAL DIMENSIONS

Thermal vias, if present, are not shown on these drawings.

All measurements are ± 0.13 mm, unless otherwise indicated.

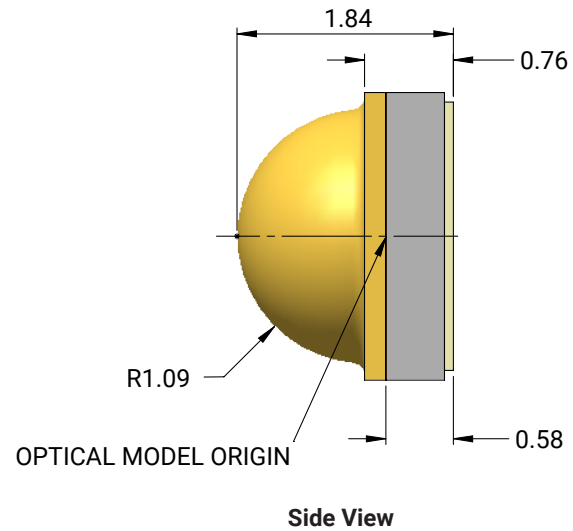
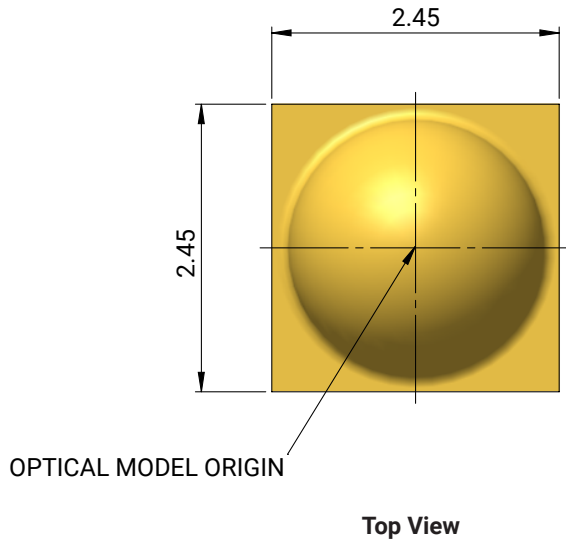

* The height of XB-D white LEDs is 1.97 ± 0.16 mm for LEDs in the E6-E8, F6-F8, and Z6-Z8 chromaticity regions.

MECHANICAL DIMENSIONS - CONTINUED

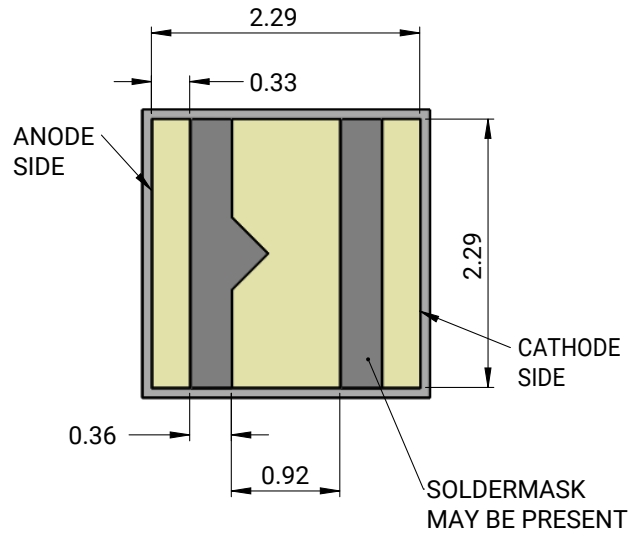

Bottom View

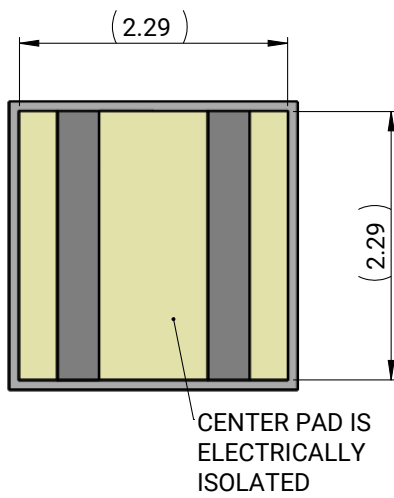

Alternate Bottom View

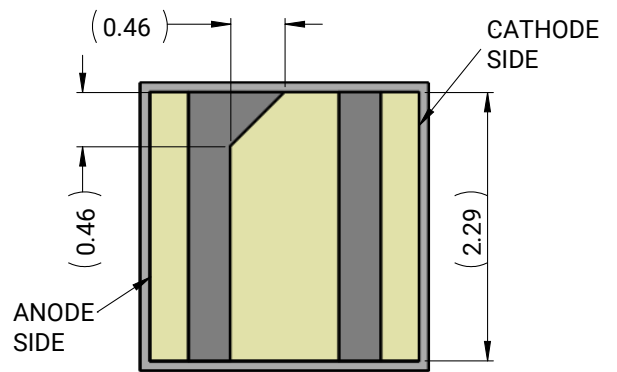

Alternate Bottom View

MECHANICAL DIMENSIONS - CONTINUED

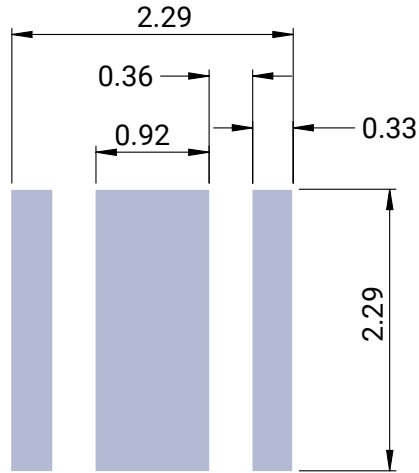

Recommended PCB Footprint

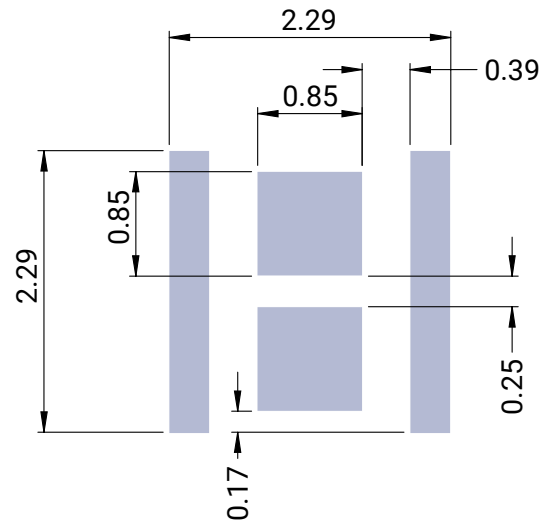

Recommended Solder Stencil

TAPE AND REEL

All Cree LED carrier tapes conform to EIA-481D, Automated Component Handling Systems Standard.

All dimensions are ± 0.13 mm unless otherwise indicated.

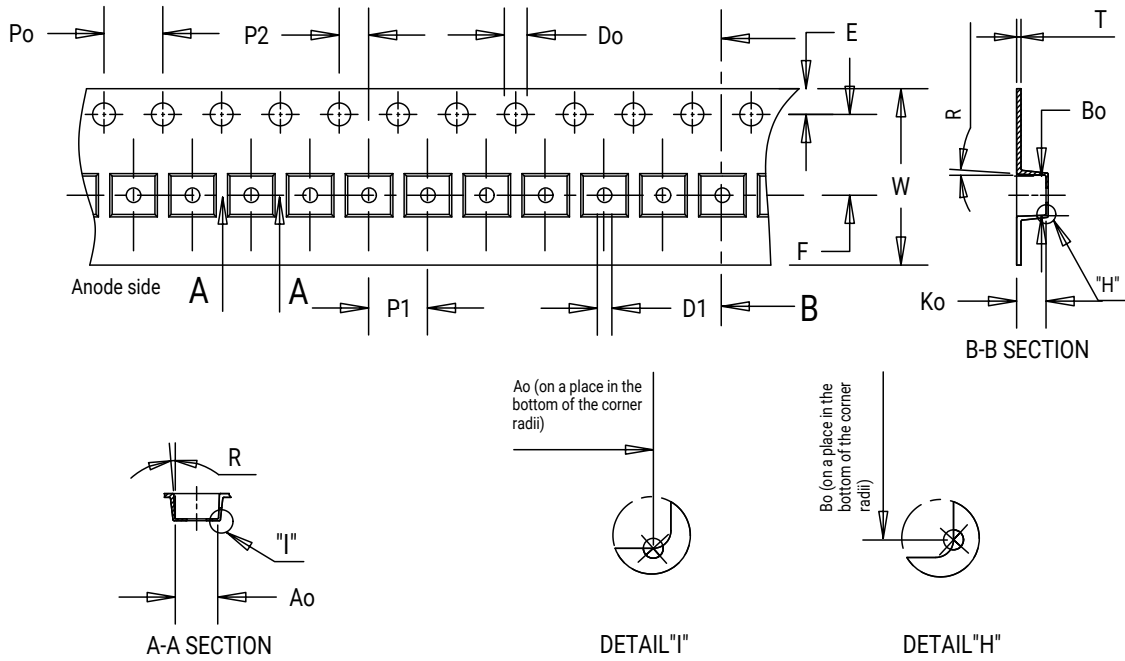

Item	Ao	Bo	Ko	Po	P1	P2	T	E	F	Do	D1	W	R
Dim.	2.60	2.60	2.05	4.00	8.00	2.00	0.30	1.75	5.50	1.50	1.50	12.00	4°

TAPE AND REEL - CONTINUED

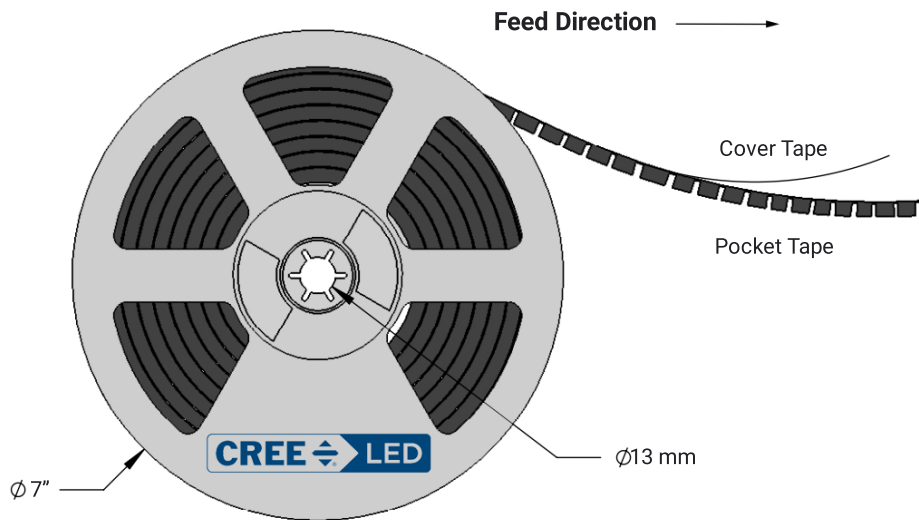
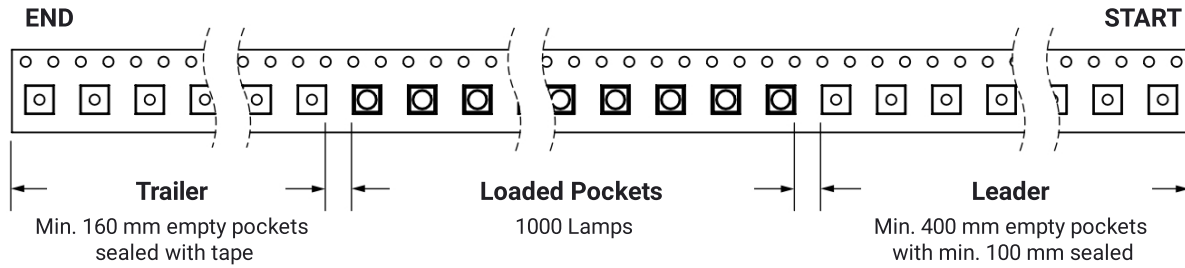

PACKAGING

Unpackaged Reel

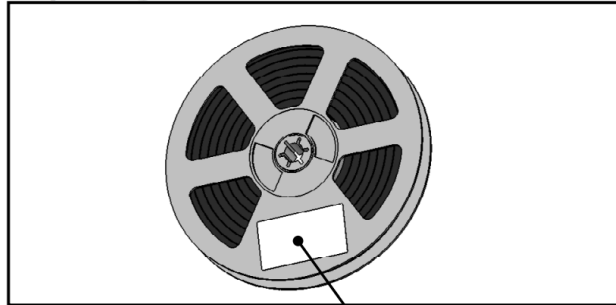

Label with Cree LED Bin Code, Quantity, Reel ID

Packaged Reel

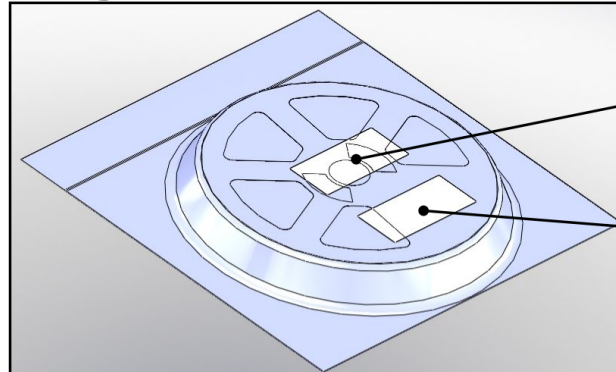

Label with Cree LED Order Code, Quantity, Reel ID, PO#

Label with Cree LED Bin Code, Quantity, Reel ID

Boxed Reel

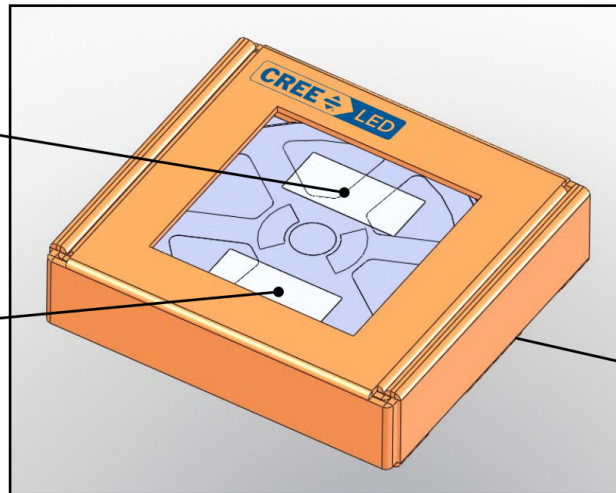

Label with Cree LED Order Code, Quantity, Reel ID, PO#

Label with Cree LED Bin Code, Quantity, Reel ID

Patent Label (on bottom of box)

APPENDIX - ORDER CODES NOT FOR NEW DESIGNS

The following order codes are active and valid order codes, but higher performance options are also available. Please see page 4 - page 9 for order codes of XLamp XB-D white LEDs that could serve as alternatives for the order codes set forth below.

XB-D ANSI Cool White

Chromaticity		Minimum Luminous Flux (lm) @ 350 mA		Order Codes		
Kit	CCT	Code	Flux (lm) @ 85 °C	No CRI Minimum	70 CRI Minimum	80 CRI Minimum
51	6200 K	R2	114	XBDAWT-00-0000-000000E51	XBDAWT-00-0000-00000BE51	
53	6000 K	R2	114	XBDAWT-00-0000-000000E53	XBDAWT-00-0000-00000BE53	
50	6200 K	R2	114	XBDAWT-00-0000-000000E50	XBDAWT-00-0000-00000BE50	
E1	6500 K	R2	114	XBDAWT-00-0000-000000EE1	XBDAWT-00-0000-00000BEE1	
E2	5700 K	R2	114	XBDAWT-00-0000-000000EE2	XBDAWT-00-0000-00000BEE2	

XB-D ANSI Neutral White

Chromaticity		Minimum Luminous Flux (lm) @ 350 mA		Order Codes			
Kit	CCT	Code	Flux (lm) @ 85 °C	No CRI Minimum	70 CRI Minimum	Standard CRI	80 CRI Minimum
E3	5000 K	R2	114	XBDAWT-00-0000-000000EE3	XBDAWT-00-0000-00000BEE3		
		Q5	107			XBDAWT-00-0000-00000LDE3	
		Q4	100			XBDAWT-00-0000-00000LCE3	
F4	4750 K	Q5	107			XBDAWT-00-0000-00000LDF4	XBDAWT-00-0000-00000HDF4
		Q4	100			XBDAWT-00-0000-00000LCF4	
E4	4500 K	Q5	107			XBDAWT-00-0000-00000LDE4	XBDAWT-00-0000-00000HDE4
		Q4	100			XBDAWT-00-0000-00000LCE4	

Notes:

- Cree LED maintains a tolerance of ±7% on flux and power measurements, ±0.005 on chromaticity (CCx, CCy) measurements and ±2 on CRI measurements. See the Measurements section (page 32).
- XLamp XB-D LED order codes specify only a minimum flux bin and not a maximum. Cree LED may ship reels in flux bins higher than the minimum specified by the order code without advance notice. Shipments will always adhere to the chromaticity or DWL bin restrictions specified by the order code.
- Typical CRI for Neutral White, 3700 K - 5000 K CCT is 75.
- Typical CRI for Warm White, 2600 K - 3700 K CCT is 80.
- Minimum CRI for 70 CRI Minimum Cool White is 70.
- Minimum CRI for 80 CRI Minimum White is 80.

APPENDIX - ORDER CODES NOT FOR NEW DESIGNS - CONTINUED

Chromaticity		Minimum Luminous Flux (lm) @ 350 mA		Order Codes			
Kit	CCT	Code	Flux (lm) @ 85 °C	No CRI Minimum	70 CRI Minimum	Standard CRI	80 CRI Minimum
F5	4250 K	Q5	107			XBDAWT00-0000-00000LDF5	XBDAWT00-0000-00000HDF5
		Q4	100			XBDAWT00-0000-00000LCF5	
		Q3	93.9			XBDAWT00-0000-00000LBF5	
E5	4000 K	Q5	107			XBDAWT00-0000-00000LDE5	XBDAWT00-0000-00000HDE5
		Q4	100			XBDAWT00-0000-00000LCE5	
		Q3	93.9			XBDAWT00-0000-00000LBE5	

XB-D ANSI Warm White

Chromaticity		Minimum Luminous Flux (lm) @ 350 mA		Order Codes				
Kit	CCT	Code	Flux (lm) @ 85 °C	No CRI Minimum	70 CRI Minimum	Standard CRI	80 CRI Minimum	90 CRI Minimum
F6	3750 K	Q4	100			XBDAWT00-0000-00000LCF6		
		Q3	93.9			XBDAWT00-0000-00000LBF6		
E6	3500 K	Q4	100			XBDAWT00-0000-00000LCE6		
		Q3	93.9			XBDAWT00-0000-00000LBE6		
F7	3250 K	Q4	100			XBDAWT00-0000-00000LCF7		
		Q3	93.9			XBDAWT00-0000-00000LBF7		
		Q2	87.4			XBDAWT00-0000-00000LAF7		
E7	3000 K	Q4	100			XBDAWT00-0000-00000LCE7		
		Q3	93.9			XBDAWT00-0000-00000LBE7		
		Q2	87.4			XBDAWT00-0000-00000LAE7		

Notes:

- Cree LED maintains a tolerance of ±7% on flux and power measurements, ±0.005 on chromaticity (CCx, CCy) measurements and ±2 on CRI measurements. See the Measurements section (page 32).
- XLamp XB-D LED order codes specify only a minimum flux bin and not a maximum. Cree LED may ship reels in flux bins higher than the minimum specified by the order code without advance notice. Shipments will always adhere to the chromaticity or DWL bin restrictions specified by the order code.
- Typical CRI for Neutral White, 3700 K - 5000 K CCT is 75.
- Typical CRI for Warm White, 2600 K - 3700 K CCT is 80.
- Minimum CRI for 70 CRI Minimum Cool White is 70.
- Minimum CRI for 80 CRI Minimum White is 80.

APPENDIX - ORDER CODES NOT FOR NEW DESIGNS - CONTINUED

Chromaticity		Minimum Luminous Flux (lm) @ 350 mA		Order Codes				
Kit	CCT	Code	Flux (lm) @ 85 °C	No CRI Minimum	70 CRI Minimum	Standard CRI	80 CRI Minimum	90 CRI Minimum
F8	2850 K	Q4	100			XBDAWT-00-0000-00000LBF8		
		Q3	93.9			XBDAWT-00-0000-00000LAF8		
		Q2	87.4			XBDAWT-00-0000-00000L9F8		
E8	2700 K	Q3	93.9			XBDAWT-00-0000-00000LBE8		
		Q2	87.4			XBDAWT-00-0000-00000LAE8		
		P4	80.6			XBDAWT-00-0000-00000L9E8		

Notes:

- Cree LED maintains a tolerance of ±7% on flux and power measurements, ±0.005 on chromaticity (CCx, CCy) measurements and ±2 on CRI measurements. See the Measurements section (page 32).
- XLamp XB-D LED order codes specify only a minimum flux bin and not a maximum. Cree LED may ship reels in flux bins higher than the minimum specified by the order code without advance notice. Shipments will always adhere to the chromaticity or DWL bin restrictions specified by the order code.
- Typical CRI for Neutral White, 3700 K - 5000 K CCT is 75.
- Typical CRI for Warm White, 2600 K - 3700 K CCT is 80.
- Minimum CRI for 70 CRI Minimum Cool White is 70.
- Minimum CRI for 80 CRI Minimum White is 80.

APPENDIX - ORDER CODES NOT FOR NEW DESIGNS - CONTINUED

The following order codes are active and valid order codes, but higher performance options are also available. Please see page 10 - page 13 for order codes of XLamp XB-D color LEDs that could serve as alternatives for the order codes set forth below.

Color, T_J = 25 °C

Blue		Minimum Luminous Flux (lm) @ 350 mA		Order Codes
Kit	Dominant Wavelength (nm)	Code	Flux (lm)	
01	465 - 485	K2	30.6	XBDBLU-00-0000-000000Y01
02	465 - 480	K2	30.6	XBDBLU-00-0000-000000Y02
05	470 - 480	K2	30.6	XBDBLU-00-0000-000000Y05

Green		Minimum Luminous Flux (lm) @ 350 mA		Order Codes
Kit	Dominant Wavelength (nm)	Code	Flux (lm)	
01	520 - 535	Q4	100	XBDGRN-00-0000-000000C01
		Q3	93.9	XBDGRN-00-0000-000000B01
		Q2	87.4	XBDGRN-00-0000-000000A01
02	520 - 530	Q4	100	XBDGRN-00-0000-000000C02
		Q3	93.9	XBDGRN-00-0000-000000B02
		Q2	87.4	XBDGRN-00-0000-000000A02
03	525 - 535	Q4	100	XBDGRN-00-0000-000000C03
		Q3	93.9	XBDGRN-00-0000-000000B03
		Q2	87.4	XBDGRN-00-0000-000000A03

Amber		Minimum Luminous Flux (lm) @ 350 mA		Order Codes
Kit	Dominant Wavelength (nm)	Code	Flux (lm)	
01	585 - 595	N4	62	XBDAMB-00-0000-000000601
		N3	56.8	XBDAMB-00-0000-000000501
03	590 - 595	N4	62	XBDAMB-00-0000-000000603
		N3	56.8	XBDAMB-00-0000-000000503

Notes:

- XLamp XB-D LED order codes specify only a minimum flux bin and not a maximum. Cree LED may ship reels in flux bins higher than the minimum specified by the order code without advance notice. Shipments will always adhere to the chromaticity or DWL bin restrictions specified by the order code.

APPENDIX - ORDER CODES NOT FOR NEW DESIGNS - CONTINUED

Red-Orange		Minimum Luminous Flux (lm) @ 350 mA		Order Codes
Kit	Dominant Wavelength (nm)	Code	Flux (lm)	
01	610 - 620	P4	80.6	XBDRDO-00-0000-000000901
		P3	73.9	XBDRDO-00-0000-000000801
02	610 - 615	P4	80.6	XBDRDO-00-0000-000000902
		P3	73.9	XBDRDO-00-0000-000000802
03	615 - 620	P4	80.6	XBDRDO-00-0000-000000903
		P3	73.9	XBDRDO-00-0000-000000803



Red		Minimum Luminous Flux (lm) @ 350 mA		Order Codes
Kit	Dominant Wavelength (nm)	Code	Flux (lm)	
01	620 - 630	N4	62	XBDRED-00-0000-000000601
		N3	56.8	XBDRED-00-0000-000000501
		N2	51.7	XBDRED-00-0000-000000401
02	620 - 625	N4	62	XBDRED-00-0000-000000602
		N3	56.8	XBDRED-00-0000-000000502
		N2	51.7	XBDRED-00-0000-000000402

Notes:

- XLamp XB-D LED order codes specify only a minimum flux bin and not a maximum. Cree LED may ship reels in flux bins higher than the minimum specified by the order code without advance notice. Shipments will always adhere to the chromaticity or DWL bin restrictions specified by the order code.

Looking for pricing, stock, or lifecycle information?

Click below to explore more details on WIN SOURCE:

-  [View XBDAWT-00-0000-000000EE3 on WIN SOURCE](#)
-  [CreeLED, Inc. Information](#)

Optimize Your Supply Chain with WIN SOURCE Solutions

-  Global Sourcing Solution
-  Obsolete Management
-  Cost Control Management
-  Shortage Management
-  Alternative Solution
-  Excess Inventory Management