



**THE DATASHEET OF
HMC1048LC3BTR**





GaAs MMIC DOUBLE-BALANCED MIXER, 2 - 18 GHz

Typical Application

The HMC1048LC3B is ideal for:

- Ka-band Transponders
- Point-to-Multi-Point Radios & VSAT
- Test Equipment & Sensors
- Military End-Use

Features

Passive: No DC Bias Required

High Input IP3: 23 dBm

LO/RF Isolation: 38 dB

LO/IF Isolation: 28 dB

RF/IF Isolation: 15 dB

IF Bandwidth: DC - 4 GHz

Downconverter Applications

12 Lead Ceramic 3 x 3 mm SMT Package: 9 mm²

Functional Diagram

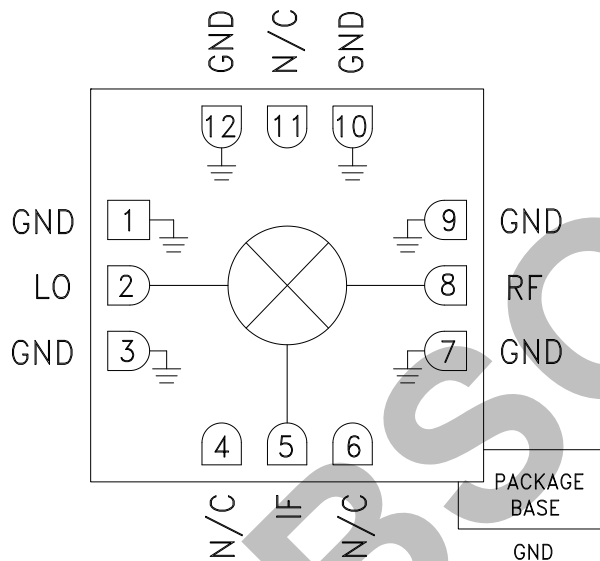

General Description

The HMC1048LC3B is a general purpose double balanced mixer that can be used as a downconverter with DC to 4 GHz at the IF port and 2 to 18 GHz at the RF port. This mixer requires no external components or matching circuitry. The HMC1048LC3B provides excellent LO/RF, LO/IF and RF/IF isolation. The mixer operates with LO drive levels from +9 dBm to +17 dBm. The HMC1048LC3B eliminates the need for wire bonding and allows the use of surface mount manufacturing techniques.

Electrical Specifications, $T_A = +25\text{ }^\circ\text{C}$, Downconverter, IF = 100 MHz, LO = +13 dBm^[1]

Parameter	Min.	Typ.	Max.	Min.	Typ.	Max.	Units
Frequency Range, RF & LO	2 - 12		12 - 18				GHz
Frequency Range, IF	DC - 4		DC - 4				GHz
Conversion Loss		9	12		11	13	dB
LO to RF Isolation ^[2]	28	38		28	35		dB
LO to IF Isolation ^[2]	15	20		18	28		dB
RF to IF Isolation	8	15		6	12		dB
IP3 (Input)		20			23		dBm
1 dB Gain Compression (Input)		10			13		dBm

[1] Unless otherwise noted all measurements performed as an Downconverter.

[2] Fixed IF = 100 MHz.



GaAs MMIC DOUBLE-BALANCED MIXER, 2 - 18 GHz

Conversion Gain vs. Temperature, IF = 100 MHz, LO = 13 dBm

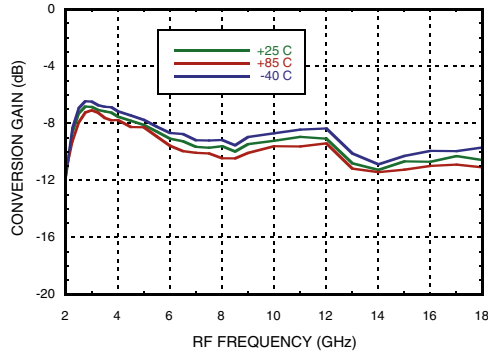

Conversion Gain vs. LO Power, IF = 100 MHz

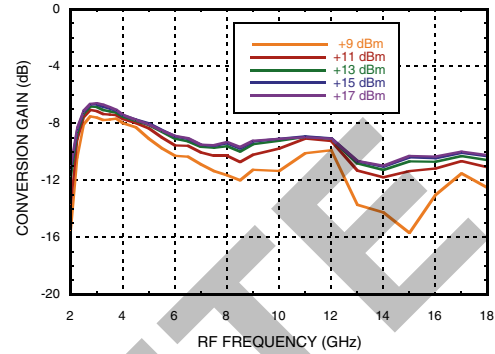

Input IP3 vs. Temperature, IF = 100 MHz, LO = 13 dBm

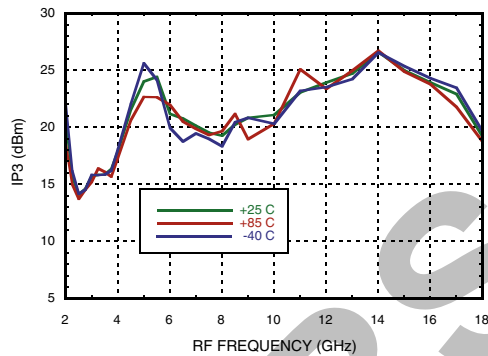

Input IP3 vs. LO Power, IF = 100 MHz

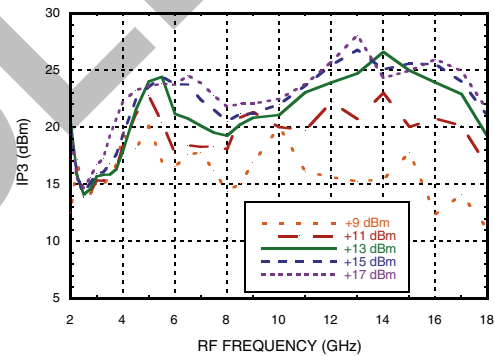

RF and LO Return Loss

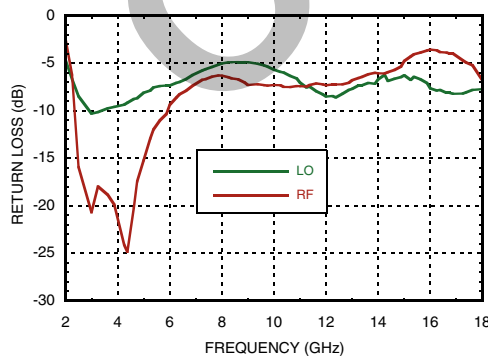

Isolation

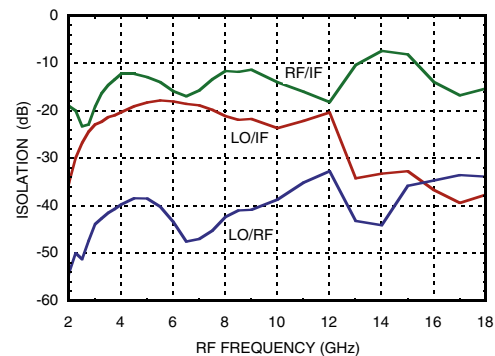

Information furnished by Analog Devices is believed to be accurate and reliable. However, no responsibility is assumed by Analog Devices for its use, nor for any infringements of patents or other rights of third parties that may result from its use. Specifications subject to change without notice. No license is granted by implication or otherwise under any patent or patent rights of Analog Devices. Trademarks and registered trademarks are the property of their respective owners.

For price, delivery, and to place orders: Analog Devices, Inc., One Technology Way, P.O. Box 9106, Norwood, MA 02062-9106 Phone: 781-329-4700 • Order online at www.analog.com Application Support: Phone: 1-800-ANALOG-D



**GaAs MMIC DOUBLE-BALANCED
MIXER, 2 - 18 GHz**

MIXER - DOUBLE-BALANCED - SMT

**IF Bandwidth @ LO = 13 dBm,
LO = 2.4 GHz**

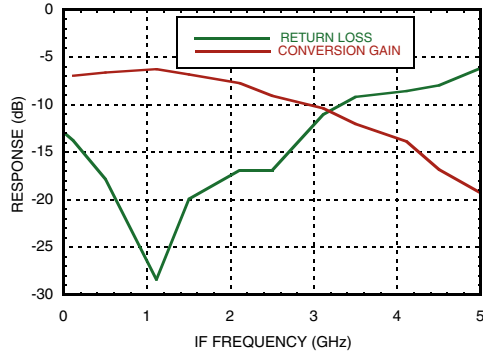

**Input P1dB vs. Temperature
IF = 100 MHz, LO = 13 dBm**

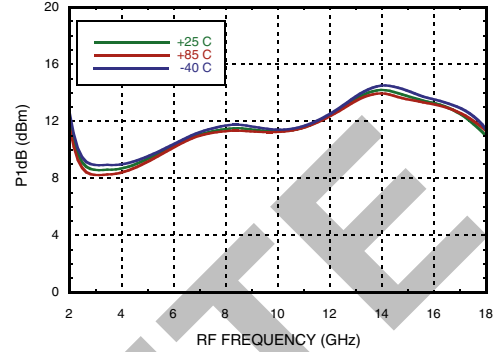

**Conversion Gain vs. Temperature,
IF = 500 MHz, LO = 13 dBm**

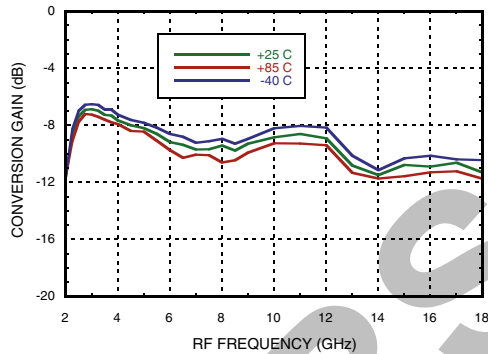

**Conversion Gain vs. LO Power,
IF = 500 MHz**

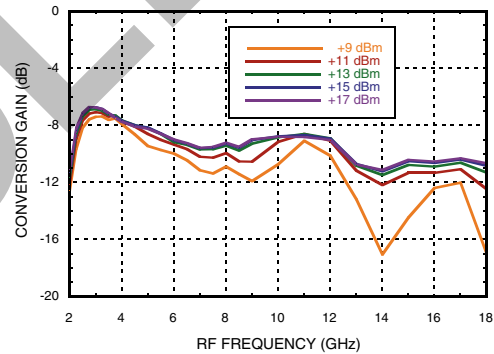

**Input IP3 vs. Temperature,
IF = 500 MHz, LO = 13 dBm**

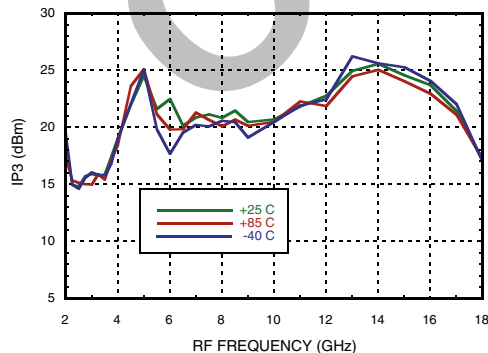

**Input IP3 vs. LO Power
IF = 500 MHz**

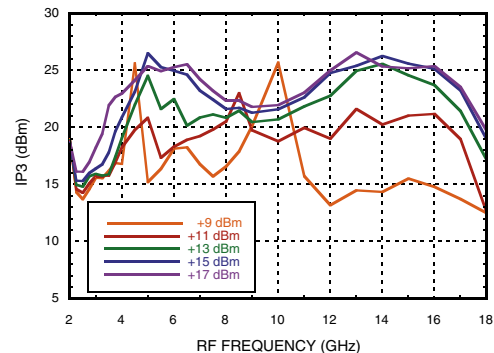

Information furnished by Analog Devices is believed to be accurate and reliable. However, no responsibility is assumed by Analog Devices for its use, nor for any infringements of patents or other rights of third parties that may result from its use. Specifications subject to change without notice. No license is granted by implication or otherwise under any patent or patent rights of Analog Devices. Trademarks and registered trademarks are the property of their respective owners.

For price, delivery, and to place orders: Analog Devices, Inc., One Technology Way, P.O. Box 9106, Norwood, MA 02062-9106 Phone: 781-329-4700 • Order online at www.analog.com Application Support: Phone: 1-800-ANALOG-D



**GaAs MMIC DOUBLE-BALANCED
MIXER, 2 - 18 GHz**

**Conversion Gain vs. Temperature,
IF = 1500 MHz, LO = 13 dBm**

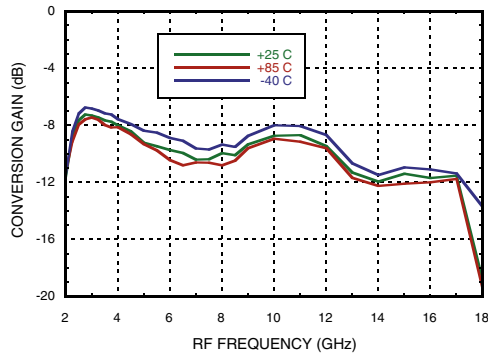

**Conversion Gain vs. LO Power,
IF = 1500 MHz**

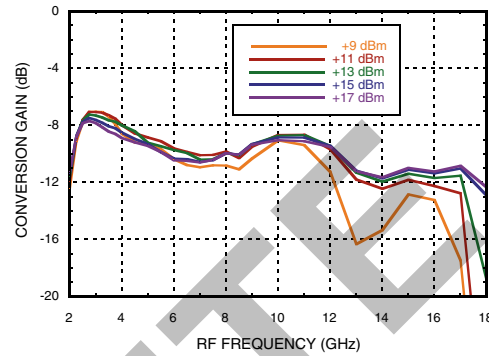

**Input IP3 vs. Temperature,
IF = 1500 MHz, LO = 13 dBm**

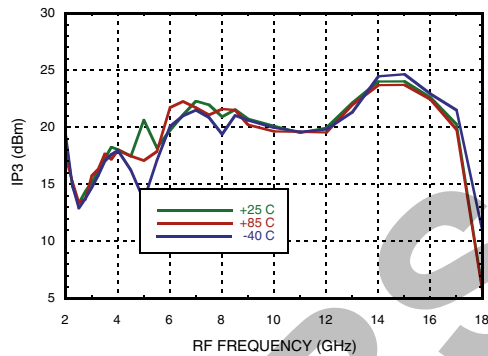

**Input IP3 vs. LO Power,
IF = 1500 MHz**

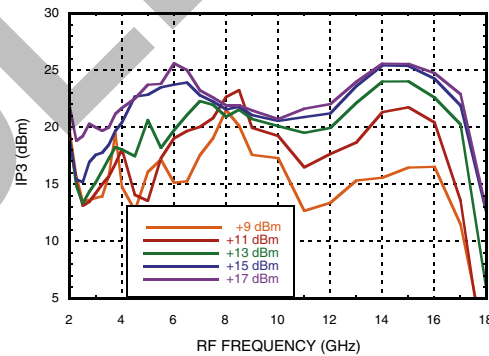



GaAs MMIC DOUBLE-BALANCED MIXER, 2 - 18 GHz

MxN Spurious Outputs, Downconverter

mRF	nLO				
	0	1	2	3	4
0	x	-0.5	26.8	-2.4	29.6
1	7.5	0	16.2	18.8	28.5
2	62.2	55.2	55.5	48.1	58.3
3	65	63.7	63.6	67.7	67.3
4	63.5	67.1	65.3	68.9	69.3

RF = 2 GHz @ -10 dBm
 LO = 2.1 GHz @ +13 dBm
 All values in dBc below IF power level

MxN Spurious Outputs, Upconverter

mIF	nLO				
	0	1	2	3	4
0	x	-10.3	16.6	15.2	29.5
1	5.4	0	26.7	24	36.3
2	55.6	39.6	52.2	39.9	52
3	65.4	60.1	57.7	63.8	64.5
4	64.6	66.7	67.1	69.8	71.7

RF = 4 GHz @ -10 dBm
 LO = 4.1 GHz @ +13 dBm
 All values in dBc below RF power level

Harmonics of LO

LO Freq. (GHz)	nLO Spur at RF Port			
	1	2	3	4
2	60.76	45.98	58.15	56.06
4	39.86	31.63	49.77	43.87
6	43.29	31.08	51.66	58.58
10	39.12	31.05	62.34	64.12
12	32.53	42.18	32.52	70.08
14	45.01	53.44	41.58	NA

LO = +13 dBm
 Values in dBc below LO level measured at RF Port.



GaAs MMIC DOUBLE-BALANCED MIXER, 2 - 18 GHz

Absolute Maximum Ratings

RF / IF Input(LO = +18 dBm)	+15.5 dBm
LO Drive	+20 dBm
Max Junction Temperature @ 85°C w/ 19 dBm	116 °C
Continuous Pdiss (T = 85 °C) (derate 2.5 mW/°C above 85 °C)	165 mW
Thermal Resistance (R _{TH}) (junction to package bottom)	392 °C/W
Storage Temperature	-65 to +150 °C
Operating Temperature	-55 to +85 °C
ESD Sensitivity (HBM)	Class 1A



ELECTROSTATIC SENSITIVE DEVICE
OBSERVE HANDLING PRECAUTIONS

Outline Drawing

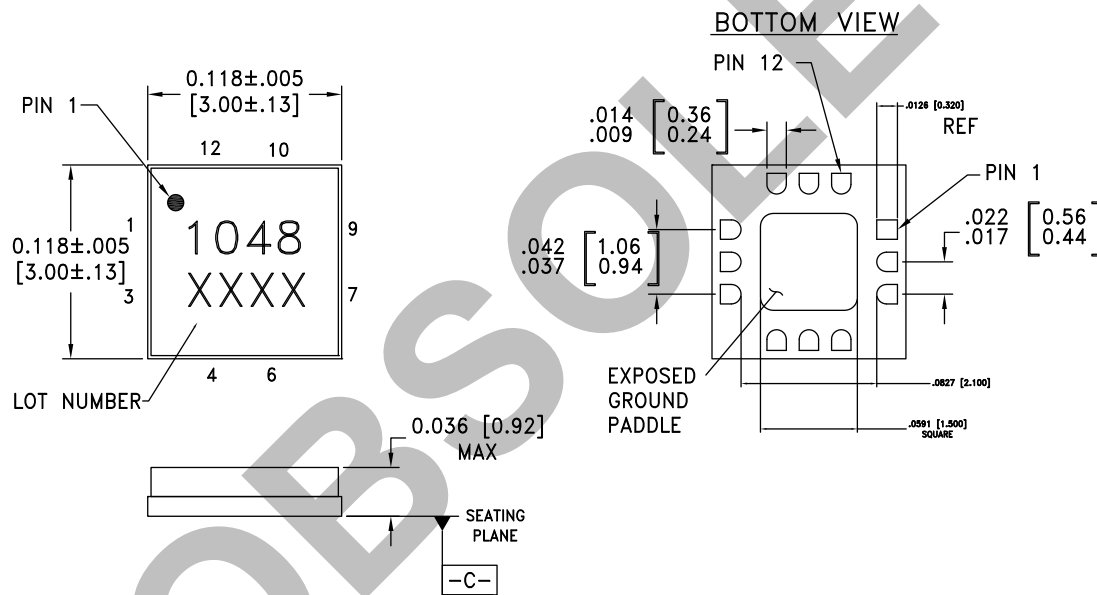

NOTES:

1. PACKAGE BODY MATERIAL: ALUMINA
2. LEAD AND GROUND PADDLE PLATING: 30-80 MICROINCHES GOLD OVER 50 MICROINCHES MINIMUM NICKEL.
3. DIMENSIONS ARE IN INCHES [MILLIMETERS].
4. LEAD SPACING TOLERANCE IS NON-CUMULATIVE.
5. CHARACTERS TO BE BLACK INK MARKED WITH .018"MIN to .030"MAX HEIGHT REQUIREMENTS. UTILIZE MAXIMUM CHARACTER HEIGHT BASED ON LID DIMENSIONS AND BEST FIT. LOCATE APPROX. AS SHOWN.
6. PACKAGE WARP SHALL NOT EXCEED 0.05mm DATUM -C-
7. ALL GROUND LEADS AND GROUND PADDLE MUST BE SOLDERED TO PCB RF GROUND.

Package Information

Part Number	Package Body Material	Lead Finish	MSL Rating	Package Marking ^[2]
HMC1048LC3B	Alumina, White	Gold over Nickel	MSL3 ^[1]	H1048 XXXX

[1] Max peak reflow temperature of 260 °C

[2] 4-Digit lot number XXXX

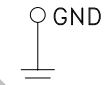
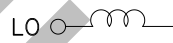
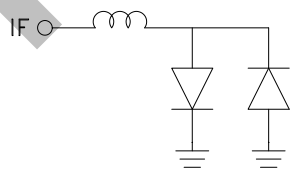
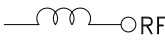

**GaAs MMIC DOUBLE-BALANCED
MIXER, 2 - 18 GHz**
Pin Descriptions

Pin Number	Function	Description	Interface Schematic
1, 3, 7, 9, 10, 12	GND	These pins and the exposed ground paddle must be connected to RF/DC ground.	
2	LO	This pin is matched to 50 Ohms.	
4, 6, 11	N/C	No connection required. These pins are not connected internally: However, all data shown herein was measured with these pins connected to ground.	
5	IF	This pin is DC coupled matched to 50 Ohms	
8	RF	This pin is matched to 50 Ohms	

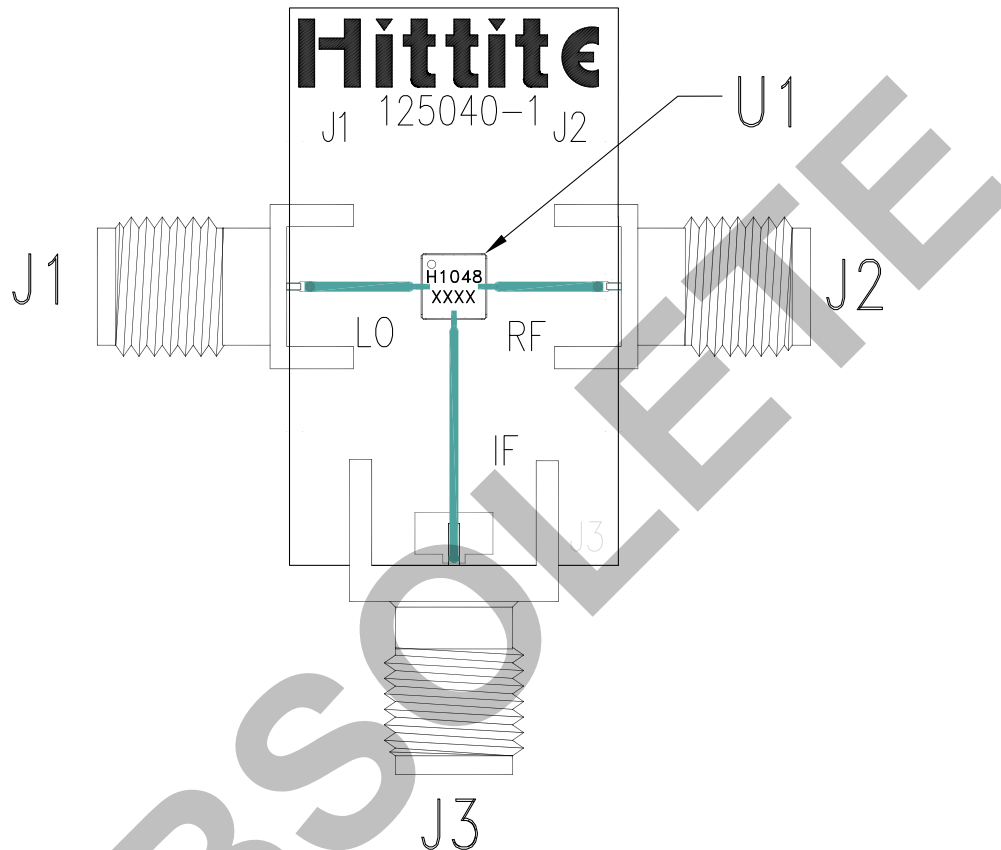

**GaAs MMIC DOUBLE-BALANCED
MIXER, 2 - 18 GHz**

Evaluation PCB



List of Materials for Evaluation PCB EVAL01-HMC1048LC3B [1]

Item	Description
J1-J2	PCB Mount 2.9 mm K Connector, SRI
J3	PCB Mount SMA Connector
U1	HMC1048LC3B
PCB [2]	125040-1 Evaluation Board

[1] Reference this number when ordering complete evaluation PCB

[2] Circuit Board Material: Rogers 4350

The circuit board used in the application should use RF circuit design techniques. Signal lines should have 50 Ohm impedance while the package ground leads and exposed paddle should be connected directly to the ground plane similar to that shown. A sufficient number of via holes should be used to connect the top and bottom ground planes. The evaluation circuit board shown is available from Hittite upon request.

Looking for pricing, stock, or lifecycle information?

Click below to explore more details on WIN SOURCE:

 [View HMC1048LC3BTR on WIN SOURCE](#)

 [Analog Devices Inc. Information](#)

Optimize Your Supply Chain with WIN SOURCE Solutions

-  Global Sourcing Solution
-  Obsolete Management
-  Cost Control Management
-  Shortage Management
-  Alternative Solution
-  Excess Inventory Management