



**THE DATASHEET OF
FN2070-10-06**



Multi-stage Performance AC/DC EMI Filter



- Rated currents from 1 to 36 A
- High differential and common-mode attenuation
- High frequency attenuation
- Optional medical versions (B type)
- Optional safety versions (A type)



Approvals & Compliances



Features and Benefits

- FN2070 two-stage filters are designed for easy and fast chassis mounting
- FN2070 B versions without capacitors to earth comply to 1MOP for ME (medical equipment) acc. IEC 60601-1
- FN2070 A version with low capacitance to earth for safety critical applications with necessity for low leakage currents
- All filters provide a high conducted attenuation performance, based on chokes with high saturation resistance and excellent thermal behavior
- FN2070 two-stage filters are designed for high frequency attenuation
- FN2070 filters are also available as single-stage filters (FN2030 series)
- FN2070 filters are also available with differential mode choke (FN2080 series)
- Various terminal options allow you to select the desired connection style

Technical Specifications

Maximum continuous operating voltage	250 VAC, 50/60 Hz 250 VDC
Nominal operating voltage	230 VAC
Rated currents	1 to 36 A @ 40°C
Operating frequency	DC to 400 Hz
High potential test voltage	P → PE 2000 VAC for 2 sec P → PE 2500 VAC for 2 sec (B types) P → N 1100 VDC for 2 sec
Overvoltage category	II acc. IEC 60664-1
Pollution degree	2 acc. IEC 60664-1
Temperature range (operation and storage)	-25°C to +100°C (25/100/21)**
Altitude	2000m (above derating applies)**
Flammability corresponding to	Laces for -07 version: UL 94 VW-1 Terminal plastic for -06/-08 version: UL 94 V-0 Grommet for -07 version: UL 94V-0
Certified to	UL 1283, CSA 22.2 No. 8 1986, IEC/EN 60939 (applies to AC and DC applications)
Design corresponding to	UL 1283, CSA 22.2 No. 8 1986, IEC/EN 60939
MTBF (Mil-HB-217F)	>1,550,000 h @ 40°C/230 V 1,600,000 h (B types) @ 40°C/230 V

- * maximum RMS operating voltage at rated frequency or the maximum DC operating voltage
 ** for dedicated requests exceeding this specification (e.g. -40 °C or higher altitude) please contact your local Schaffner Sales office

Typical Applications

- Electrical and electronic equipment
- Consumer goods
- Household equipment
- Building automation
- Industrial applications
- Machinery
- Medical equipment
- Electronic data processing equipment
- Office automation and datacom equipment
- Various noisy applications requiring good filter performance
- Single Phase Motor Drives

Typical electrical schematic

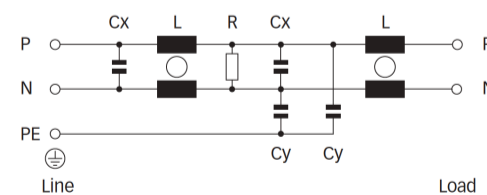

Filter Selection Table

Filter*	Buy	Rated current @ 40°C (25°C)	Leakage current** @ 250 VAC/50 Hz (@ 120 VAC/60 Hz)	Power Loss @25°C/DC	Inductance*** L	Capacitance***		Resistance*** R	Input/Output connections			Weight [g]
						Cx	Cy					
		[A]	[mA]	[W]	[mH]	[µF]	[nF]	[kΩ]				
FN2070-1-..		1 (1.2)	0.66 (0.38)	2.4	22	0.33	4.7	1000	-06	-07		190
FN2070-3-..		3 (3.5)	0.66 (0.38)	2.2	9.8	0.47	4.7	470	-06	-07		250
FN2070-6-..		6 (6.9)	0.66 (0.38)	3.2	7.8	1	4.7	220	-06	-07		450
FN2070-10-..		10 (11.5)	0.66 (0.38)	9.1	4.5	1	4.7	220	-06	-07	-08	670
FN2070-12-..		12 (13.8)	0.66 (0.38)	13.1	3.25	1	4.7	220	-06	-07	-08	670
FN2070-16-..		16 (18.4)	0.66 (0.38)	9.6	2.8	1	4.7	220	-06	-07	-08	1000
FN2070-25-08		25 (28.8)	0.66 (0.38)	11.6	2	2.2	4.7	220			-08	760
FN2070-36-08		36 (41.4)	0.66 (0.38)	13.1	1.23	2.2	4.7	220			-08	790
Enhanced performance												
FN2070A-1-..		1 (1.2)	0.07 (0.04)	2.4	22	0.33	0.47	1000	-06	-07		190
FN2070A-3-..		3 (3.5)	0.07 (0.04)	2.2	9.8	0.47	0.47	470	-06	-07		250
FN2070A-6-..		6 (6.9)	0.07 (0.04)	3.2	7.8	1	0.47	220	-06	-07		450
FN2070A-10-..		10 (11.5)	0.07 (0.04)	9.1	4.5	1	0.47	220	-06	-07	-08	670
FN2070A-12-..		12 (13.8)	0.07 (0.04)	13.1	3.25	1	0.47	220	-06	-07	-08	670
FN2070A-16-..		16 (18.4)	0.07 (0.04)	9.6	2.8	1	0.47	220	-06	-07	-08	1000
FN2070A-25-08		25 (28.8)	0.07 (0.04)	11.6	2	2.2	0.47	220			-08	760
FN2070A-36-08		36 (41.4)	0.07 (0.04)	13.1	1.23	2.2	0.47	220			-08	790
Enhanced performance												
FN2070B-1-..		1 (1.2)	0.00	2.4	22	0.33		1000	-06	-07		190
FN2070B-3-..		3 (3.5)	0.00	2.2	9.8	0.47		470	-06	-07		250
FN2070B-6-..		6 (6.9)	0.00	3.2	7.8	1		220	-06	-07		450
FN2070B-10-..		10 (11.5)	0.00	9.1	4.5	1		220	-06	-07	-08	670
FN2070B-12-..		12 (13.8)	0.00	13.1	3.25	1		220	-06	-07	-08	670
FN2070B-16-..		16 (18.4)	0.00	9.6	2.8	1		220	-06	-07	-08	1000
FN2070B-25-08		25 (28.8)	0.00	11.6	2	2.2		220			-08	760
FN2070B-36-08		36 (41.4)	0.00	13.1	1.23	2.2		220			-08	790
Enhanced performance												
FN2070M-1-06		1 (1.2)	3.69 (2.13)	2.4	22	0.33	47	1000	-06			170
FN2070M-3-06		3 (3.5)	3.69 (2.13)	2.2	9.8	0.47	47	470	-06			250
FN2070M-6-06		6 (6.9)	3.69 (2.13)	3.2	7.8	1	47	220	-06			450
FN2070M-10-..		10 (11.5)	3.69 (2.13)	9.1	4.5	1	47	220	-06		-08	670
FN2070M-12-..		12 (13.8)	3.69 (2.13)	13.1	3.25	1	47	220	-06		-08	670
FN2070M-16-..		16 (18.4)	3.69 (2.13)	9.6	2.8	1	47	220	-06		-08	1000
FN2070M-25-08		25 (28.8)	3.69 (2.13)	11.6	2	2.2	47	220			-08	750
FN2070L-36-08		36 (41.4)	2.59 (1.49)	13.1	1.23	2.2	33	220			-08	790

* To compile a complete part number, please replace the -.. with the required I/O connection style (e.g. FN 2070-25-08, FN 2070B-10-06).

** Maximum leakage under usual AC operating conditions (acc. IEC60939-3). Note: if the neutral line is interrupted, worst case leakage could reach twice this level.

*** Tolerances apply: Inductance: -30/+50%, Capacitance: ±20%, Resistance: ±10%

Typical Filter Attenuation

Per CISPR 17: symmetrical 50 Ω/50 Ω -> Differential Mode (DM); asymmetrical 50 Ω/50 Ω -> Common Mode (CM)

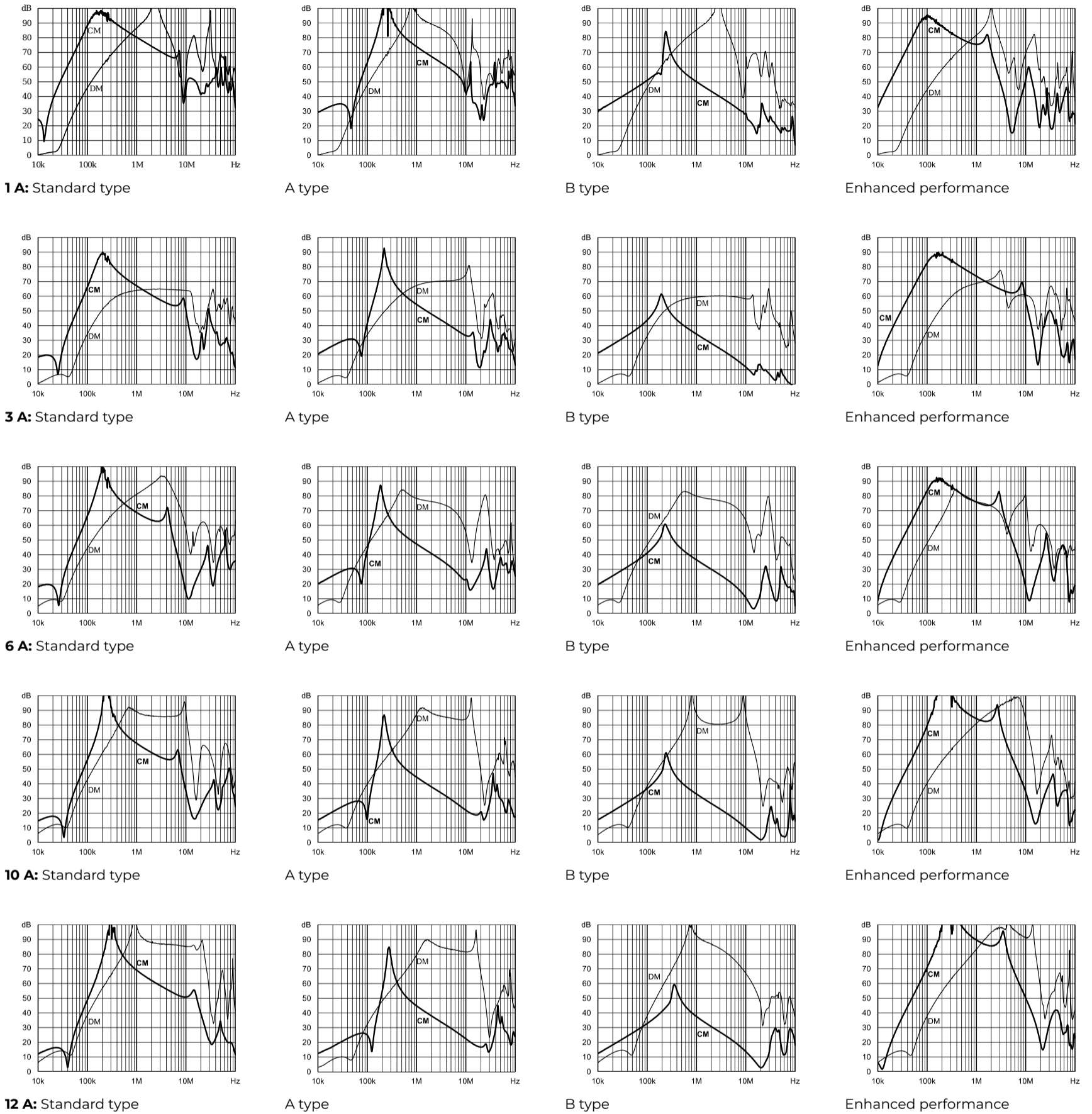

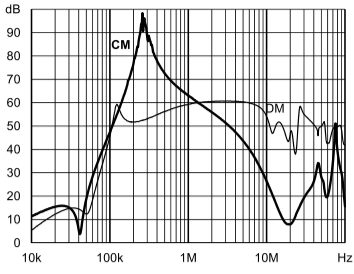

16 A: Standard type

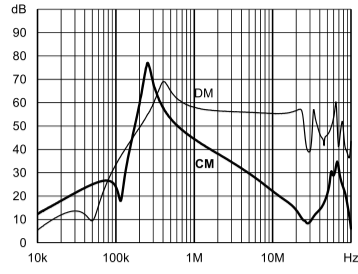

A type

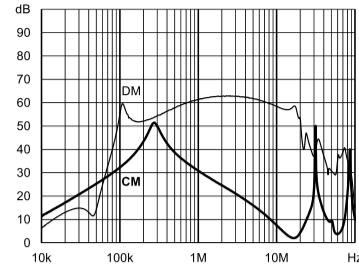

B type

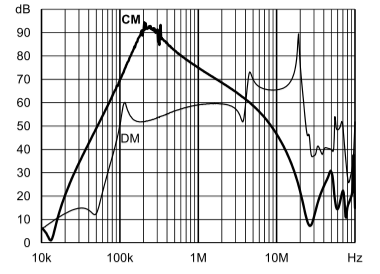

Enhanced performance

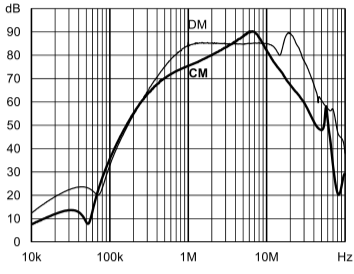

25 A: Standard type

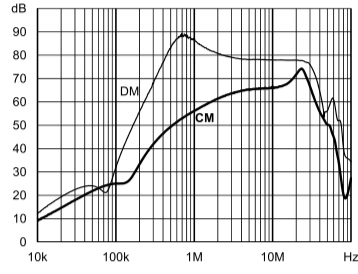

A type

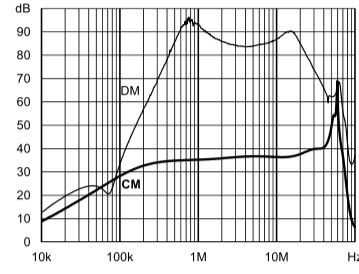

B type

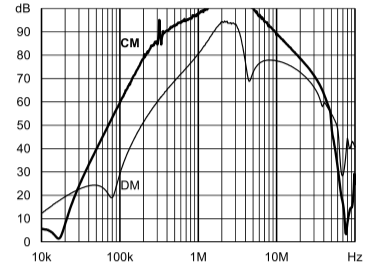

Enhanced performance

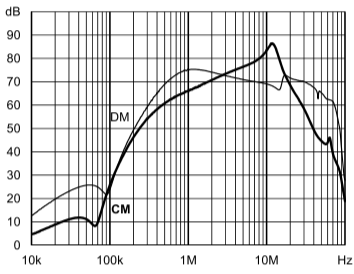

36 A: Standard type

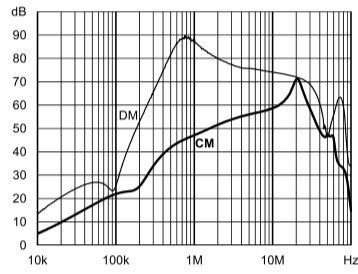

A type

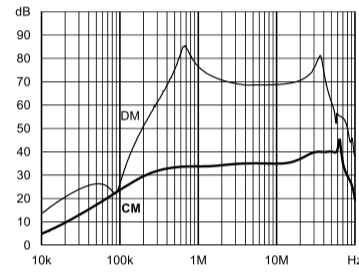

B type

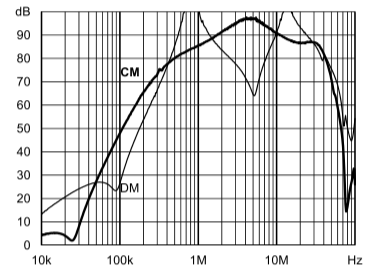

Enhanced performance

Product selector		
	06	Faston 6.3 × 0.8 mm (spade/soldering)
	07	Wire leads
	08	Studs (M4 screws)
	1 to 36	Rated current
	Blank	Standard version
	A	Safety version
	B	Medical version
	L/M	High performance version

Mechanical Data

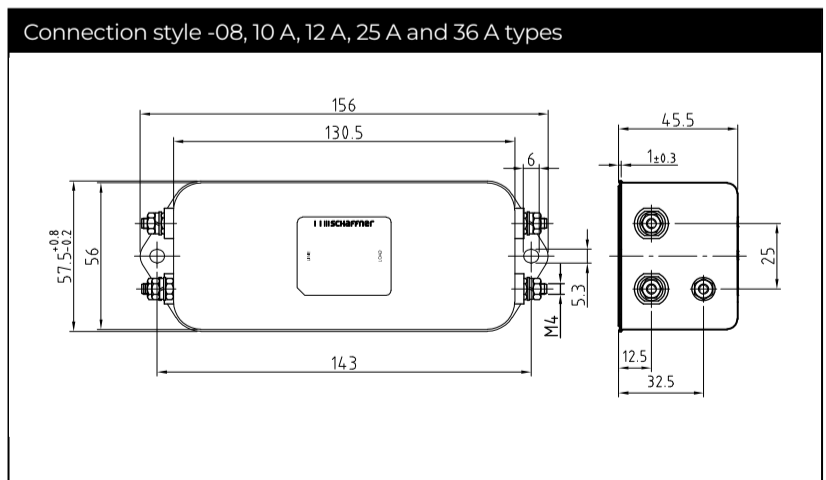
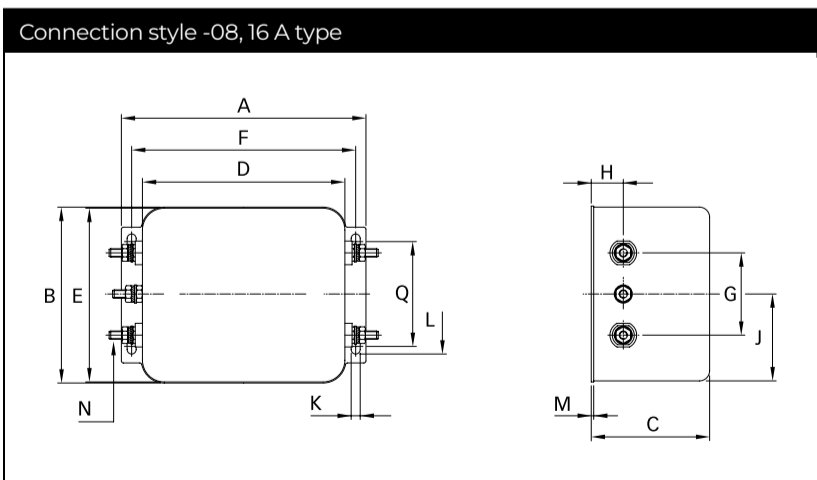
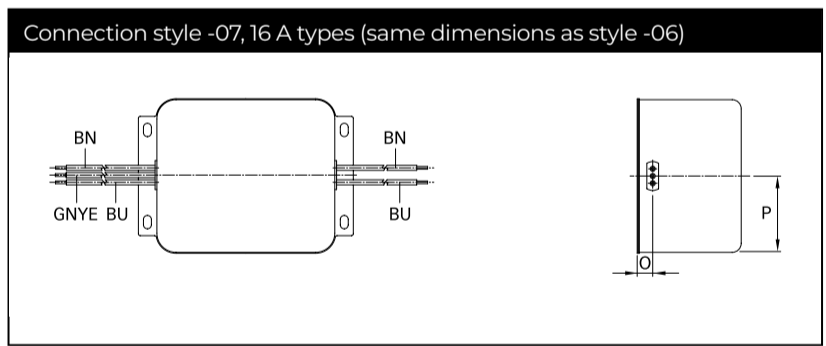
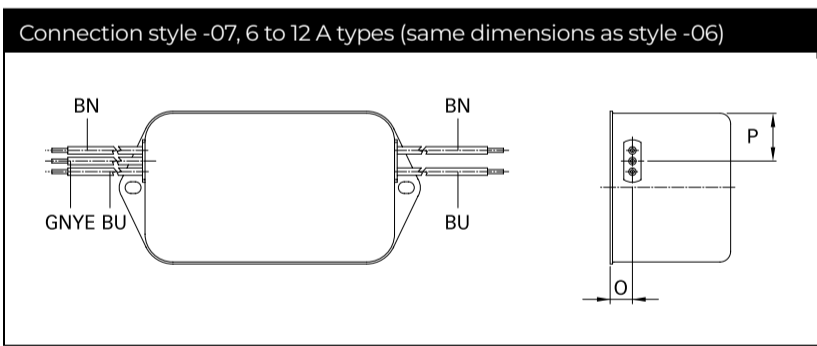
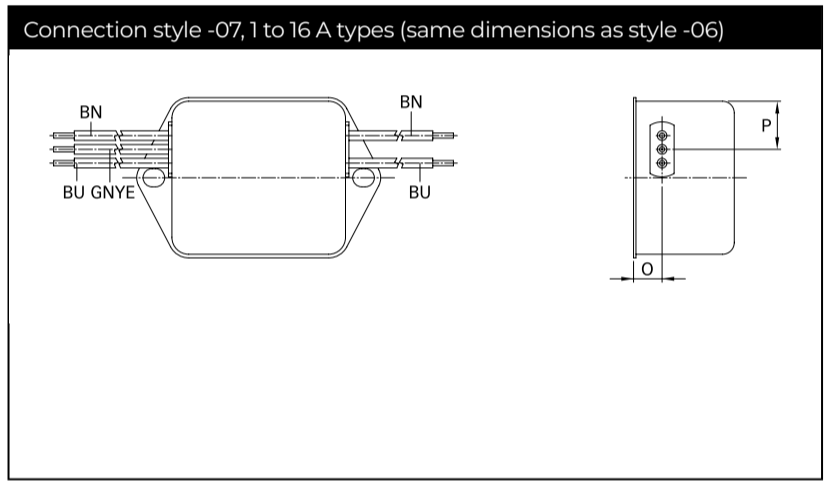
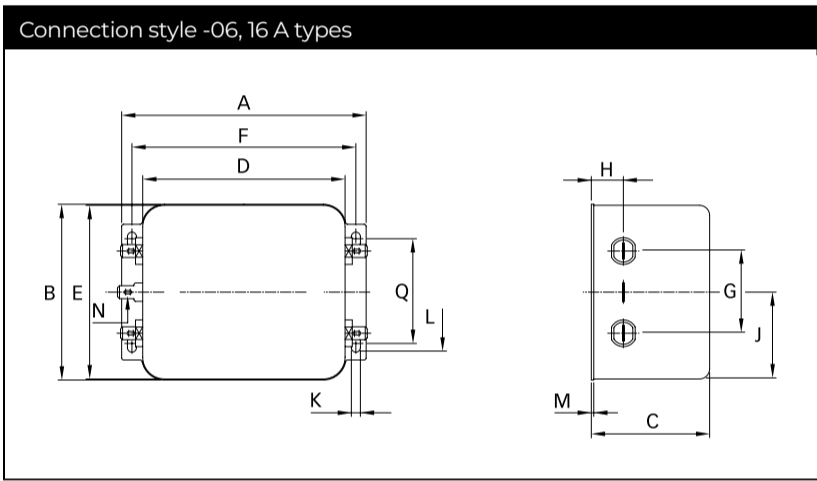
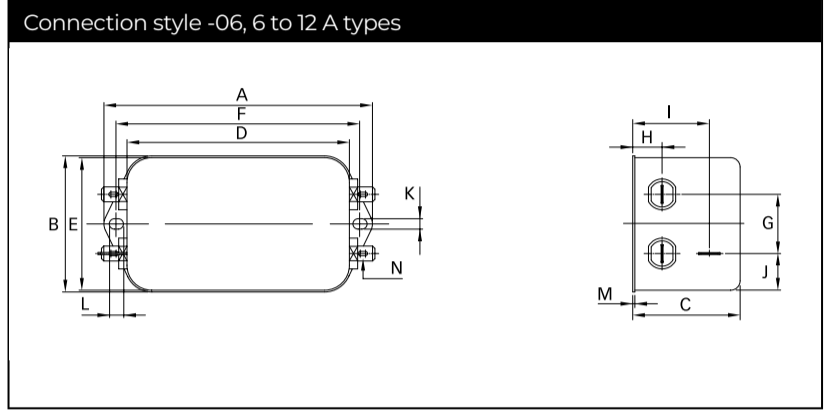
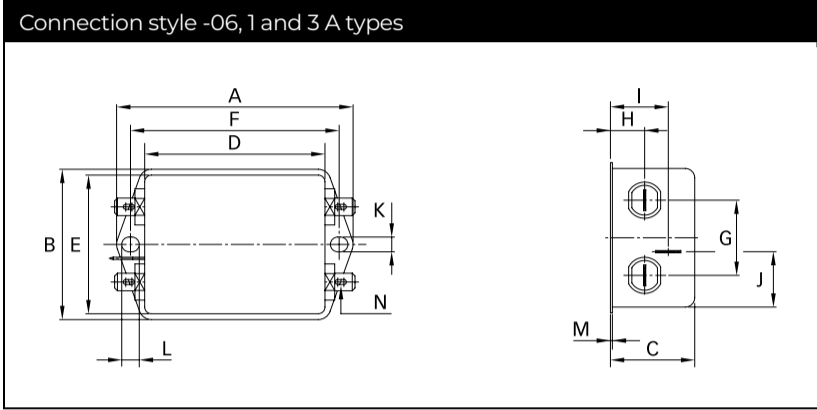

Dimensions

	1 A	3 A	6 A	10 A	12 A	16 A	25 A	36 A	Tolerances
A	85 ±0.5	85 ±0.5	113.5	156	156	119	156	156	±1
B	54 ±0.5	54 ±0.5	57.5	57.5	57.5	85.5	57.5	57.5	±1
C	30.3 ±0.5	40.3 ±0.5	45.4	45.4	45.4	57.6	45.4	45.4	±1
D	64.8 ±0.5	64.8 ±0.5	94	130.5	130.5	98.5	130.5	130.5	±1
E	49.8	49.8	56	56	56	84.5	56	56	±0.5
F	75	75	103	143	143	109	143	143	±0.3
G	27	27	25	25	25	40	25	25	±0.2
H	12.3	12.3	12.4	12.4	12.4	15.6	12.4	12.4	±0.5
I	20.8	29.8	32.4	32.5	32.5		32.5	32.5	±0.5
J	19.9	11.4	15.5	15.5	15.5	42.25	15.5	15.5	±0.5
K	5.3	5.3	4.4	5.3	5.3	4.4	5.3	5.3	
L	6.3	6.3	6	6	6	7.4	6	6	
M	0.7	0.7	1	1	1	1.2	1	1	±0.3
Connection style -06									
N	6.3 x 0.8	6.3 x 0.8	6.3 x 0.8	6.3 x 0.8	6.3 x 0.8	6.3 x 0.8			
Connection style -07									
O	8.3	8.3	8.4	8.4	8.4	8.6			±0.5
P	14.9	14.9	18	18	18	42.25			±0.5
AWG type wire	AWG 20	AWG 20	AWG 18	AWG 18	AWG 16	AWG 16			
Wire length	140	140	140	140	140	140			+5
Connection style -08									
N				M4	M4	M4	M4	M4	
Q						51			±0.2
Recommended torque (Nm)				1.2 - 1.3	1.2 - 1.3	1.2 - 1.3	1.2 - 1.3	1.2 - 1.3	
Earth terminal				1.5 - 1.7	1.5 - 1.7	1.5 - 1.7	1.5 - 1.7	1.5 - 1.7	

All dimensions in mm; 1 inch = 25.4 mm

Please visit www.schaffner.com to find more details on filter connections.

Headquarters, Global Innovation and Development

Switzerland
Schaffner Group
 Industrie Nord
 Nordstrasse 11e
 4542
 Luterbach
 +41 32 681 66 26
info@schaffner.com

Sales and Application Centers

Finland
Schaffner Oy
 Lohjanharjuntie 1109
 08500
 Lohja
 + 358 50 468 72 84
finlandsales@schaffner.com

France
Schaffner EMC S.A.S.
 16-20 Rue Louis Rameau
 95875
 Bezons
 +33 1 34 34 30 60
francesales@schaffner.com

Germany
Schaffner Deutschland GmbH
 Ohiostr. 8
 76149
 Karlsruhe
 +49 721 56910
germanysales@schaffner.com

Italy
Schaffner EMC S.r.l.
 Via Ticino, 30
 20900
 Monza (MB)
 +39 039 21 41 070
italysales@schaffner.com

Japan
Schaffner EMC K.K.
 ISM Sangenjaya 7F
 1-32-12 Kamiyama Setagaya-ku
 154-0011
 Tokyo
 +81 3 5712 3650
japansales@schaffner.com

Singapore
Schaffner EMC Pte Ltd.
 Blk 3015A Ubi Road 1 #05-09 Kampong Ubi
 Industrial Estate
 408705
 Singapore
 +65 63773283
singaporesales@schaffner.com

Sweden
Schaffner EMC AB
 Östermalmstrorg 1
 114 42
 Stockholm
 +46 8 5050 2425
swedensales@schaffner.com

Switzerland
Schaffner EMV AG
 Industrie Nord
 Nordstrasse 11e
 4542
 Luterbach
 +41 32 681 66 26
switzerlandsales@schaffner.com

India
Schaffner India Pvt. Ltd
 Regus World Trade Centre
 WTC 22nd Floor Unit No 2238 Brigade
 Gateway Campus 26/1 Dr. Rajkumar Road
 Malleshwaram (W)
 560055
 Bangalore
 +91 8067935355
indiasales@schaffner.com

United Kingdom
Schaffner Ltd.
 Suite 1 Oakmede Place
 Terrace Road
 RG42 4JF
 Binfield
 +44 118 9770070
uksales@schaffner.com

United States
Schaffner EMC Inc.
 52 Mayfield Avenue
 Edison, New Jersey
 +1 732 225 9533
usasales@schaffner.com

To find your local partner within Schaffner's global network schaffner.com

© 2024 Schaffner Group

The content of this document has been carefully checked and understood. However, neither Schaffner nor its subsidiaries assume any liability whatsoever for any errors or inaccuracies of this document and the consequences thereof. Published specifications are subject to change without notice. Product suitability for any area of application must ultimately be determined by the customer. In all cases, products must never be operated outside their published specifications. Schaffner does not guarantee the availability of all published products. This disclaimer shall be governed by substantive Swiss law and resulting disputes shall be settled by the courts at the place of business of Schaffner Holding AG. Latest publications and a complete disclaimer can be downloaded from the Schaffner website. All trademarks recognized.

Looking for pricing, stock, or lifecycle information?

Click below to explore more details on WIN SOURCE:

- [View FN2070-10-06 on WIN SOURCE](#)
- [Schaffner EMC Inc. Information](#)

Optimize Your Supply Chain with WIN SOURCE Solutions

- ✓ Global Sourcing Solution
- ✓ Obsolete Management
- ✓ Cost Control Management
- ✓ Shortage Management
- ✓ Alternative Solution
- ✓ Excess Inventory Management