



**THE DATASHEET OF  
DAC161S997EVM**



# DAC161S997EVM

## User's Guide



Literature Number: SNLU146A  
June 2013–Revised February 2016

## **DAC161S997EVM**

---

---

---

Topic	Page
1 Introduction .....	3
2 EVM Setup .....	4
3 Software Installation.....	4
4 Board Layout.....	9
5 Schematics.....	11
6 Bill of Materials .....	13

## 1 Introduction

The Texas Instruments DAC161S997EVM evaluation module (EVM) helps designers evaluate the operation and performance of the DAC161S997 4-20mA Loop Drive with SPI control. The EVM contains a low cost MSP430G2553 microcontroller which comes pre-loaded with firmware to communicate with the Labview based PC Software. A JTAG header is provided which can be used to program custom firmware. A general purpose header with SPI and microcontroller GPIOs is provided to ease development of sensor transmitters and other applications.

The EVM contains one DAC161S997 and is configured as Loop-Powered 2-Wire Transmitter see [Table 1](#).

**Table 1. Device and Package Configurations**

Converter	IC	Package
U2	DAC161S997	LLP-16

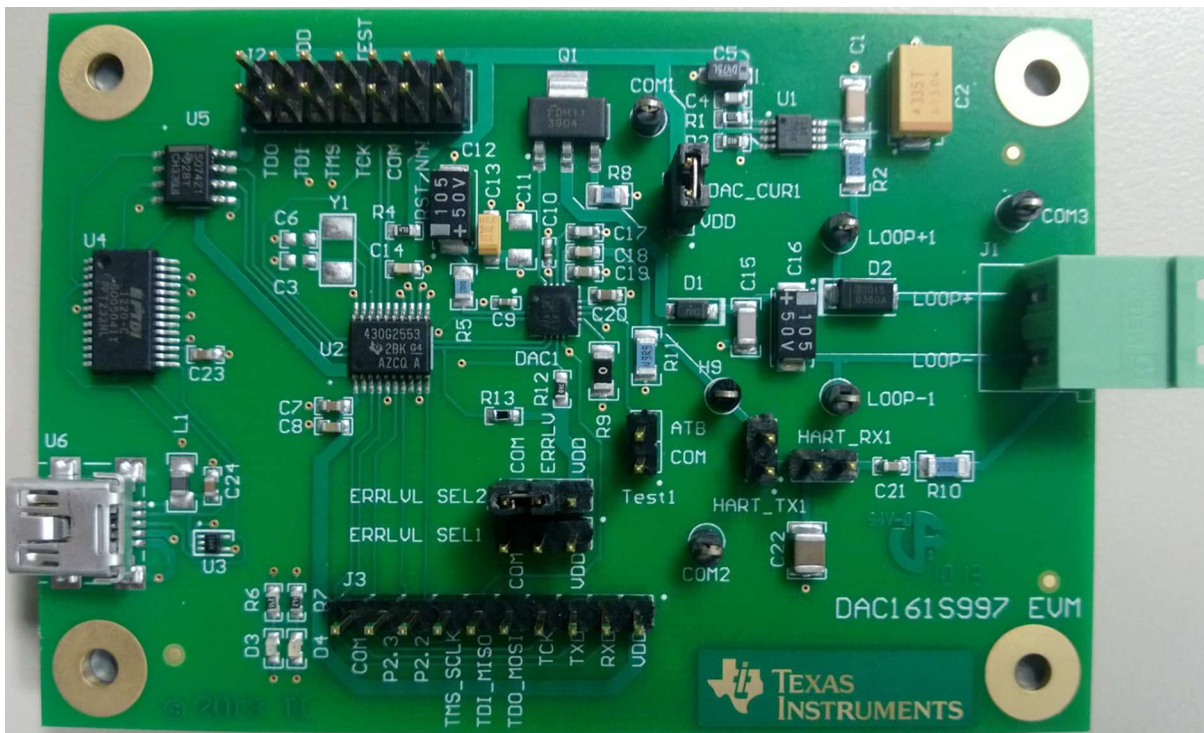

Figure 1.

## 2 EVM Setup

This section describes the jumpers and connectors on the EVM as well and how to properly connect, set up, and use the DAC161S997EVM.

### 2.1 Input/Output Connector Description

1. J1 : Loop Connector. Loop+ and Loop- Pins.
2. J2 : JTAG Connector. Used to debug/flash on-board MSP430G2553
3. J3 : General Purpose I/O. Can be used to connect to a SPI-based Analog front end such as the LMP90100 from TI's SensorAFE family.
4. DAC\_CUR: Power supply for DAC161S997. Short Pin1 and Pin2 to power-up DAC.
5. ERRLVL\_SEL1: Pin2 connected to MSP430 (GPIO P2.4) for software control of Error level signal.
6. ERRLVL\_SEL2: Pin2 connected to ERRLV pin of DAC161S997. Pin1 connected to COM and Pin3 Connected to VDD.
7. HART\_TX1: HART transmit input connector. Can be connected to an external HART modem output.
8. HART\_RX1: HART receive output connector. Can be connected to an external HART modem input.

### 2.2 EVM Connections

For proper operation of the DAC161S997EVM, first short the DAC\_CUR pins and connect jumper between Pin1 and Pin2 of ERRLVL\_SEL2 jumpers (the EVM is shipped in this configuration).

The EVM is powered through the Loop supply. Connect Loop+ pin of J1 to Positive of the supply and negative of the supply to positive terminal of ammeter and negative terminal of ammeter to Loop- pins. This configuration will supply power to EVM and can measure the Loop current.

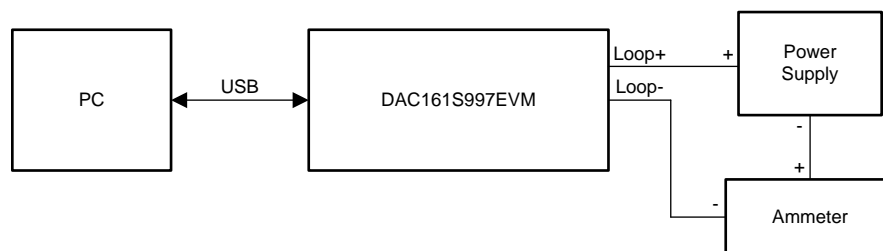

**Figure 2. EVM Connection Diagram**

## 3 Software Installation

It is recommended to use the latest version of DAC161S997 software; this can be downloaded from: <http://www.ti.com/product/dac161s997>. You must install the software before you connect the DAC161S997EVM to your PC.

To install the DAC161S997EVM software:

- Direct a browser to <http://www.ti.com/products/dac161s997>, then scroll down to the Tools & Software section to download the latest DAC161S997 software.
- Unzip the downloaded file from a known directory, and run the "setup.exe" in /TI\_DAC161S997\_Installer/Volume/

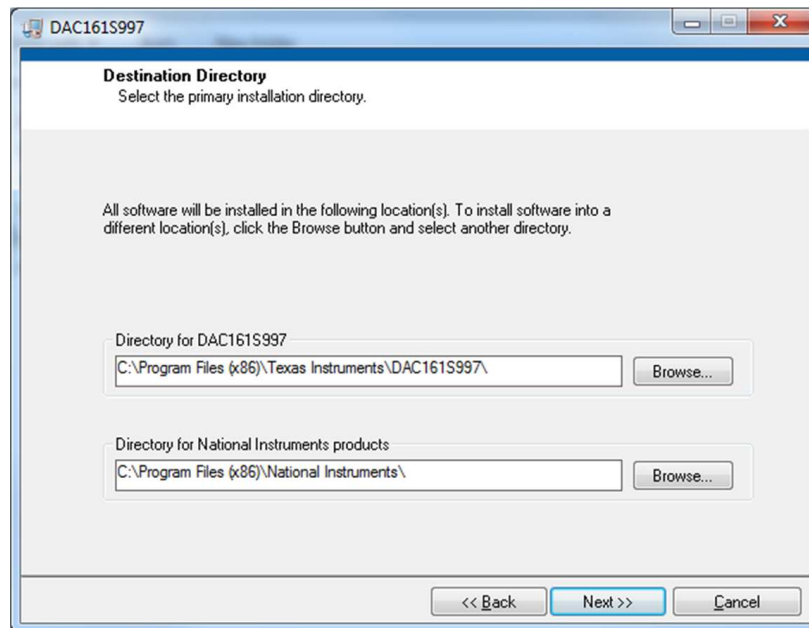

**Figure 3.**

- Click Next, read the license agreement and complete the first portion of the installation.
- Next, the FTDI drivers are installed automatically.

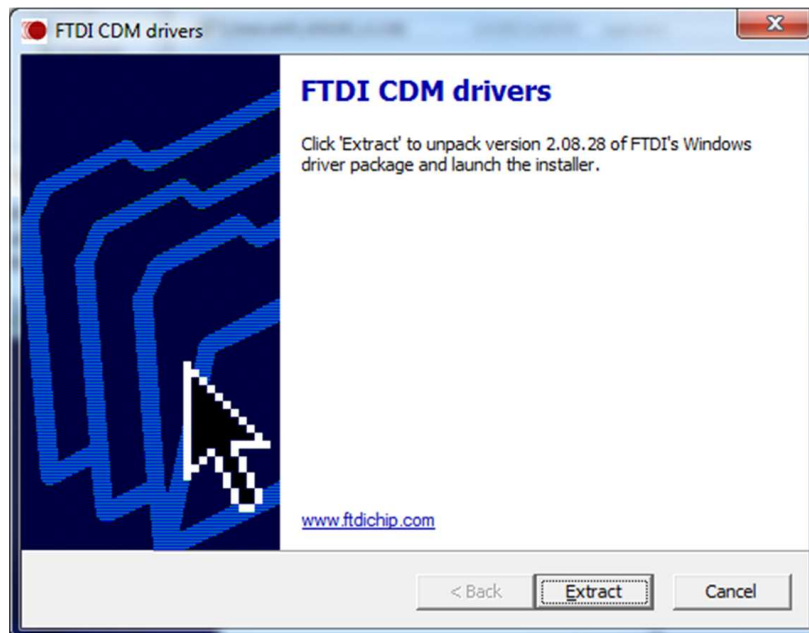

**Figure 4.**

- Click Extract and the following window will appear:

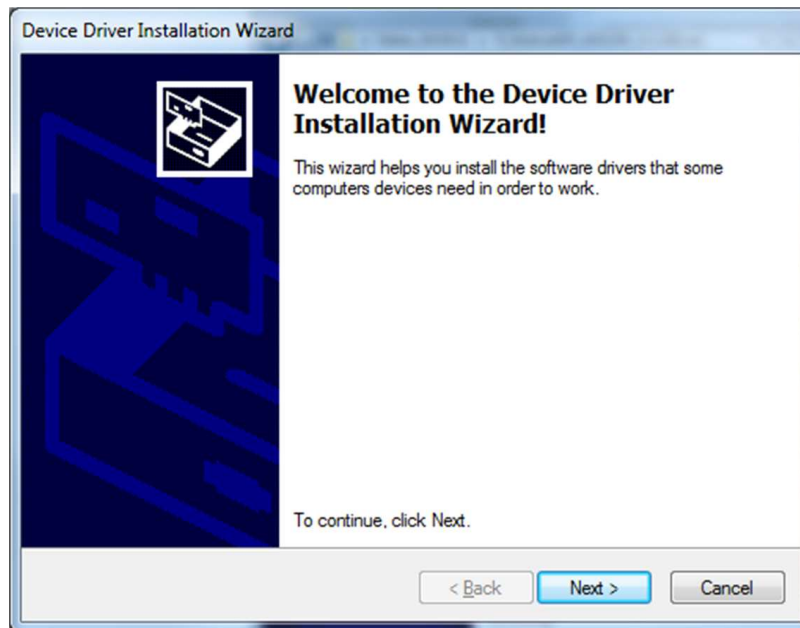

**Figure 5.**

- Click Next. Once the drivers are installed a Completing the Device Driver Installation Wizard window. Then, Click Finish to complete the installation.



**Figure 6.**

- Before you launch the DAC161S997 Software, Connect connect the DAC161S997EVM to a USB port of your computer and connect the Loop supply voltage.
- Open the computer's "Device Manager" and verify that a new COM port named "USB Serial Port" has been added in the Ports(COM&LPT) section.

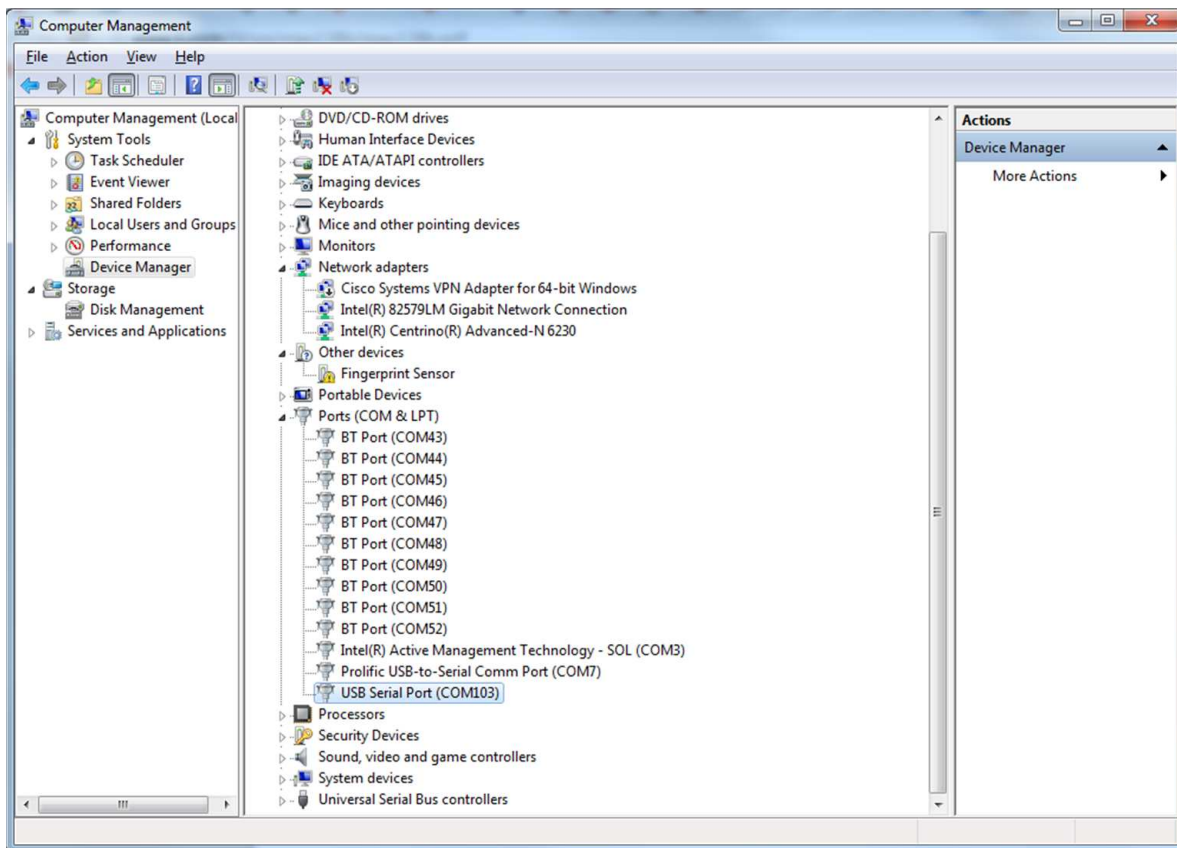

**Figure 7.**

- Make a note of the assigned COM port number; this number is needed to connect the PC to the DAC161S997EVM.
- Run the DAC161S997 Software and select the COM port that was assigned and click on connect.

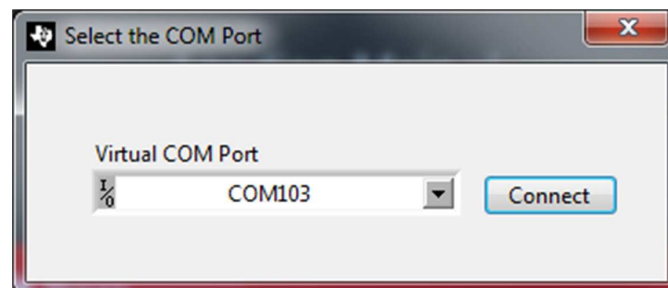

**Figure 8.**

- On start-up, the software retrieves all the DAC161S997 registers and updates the software accordingly.

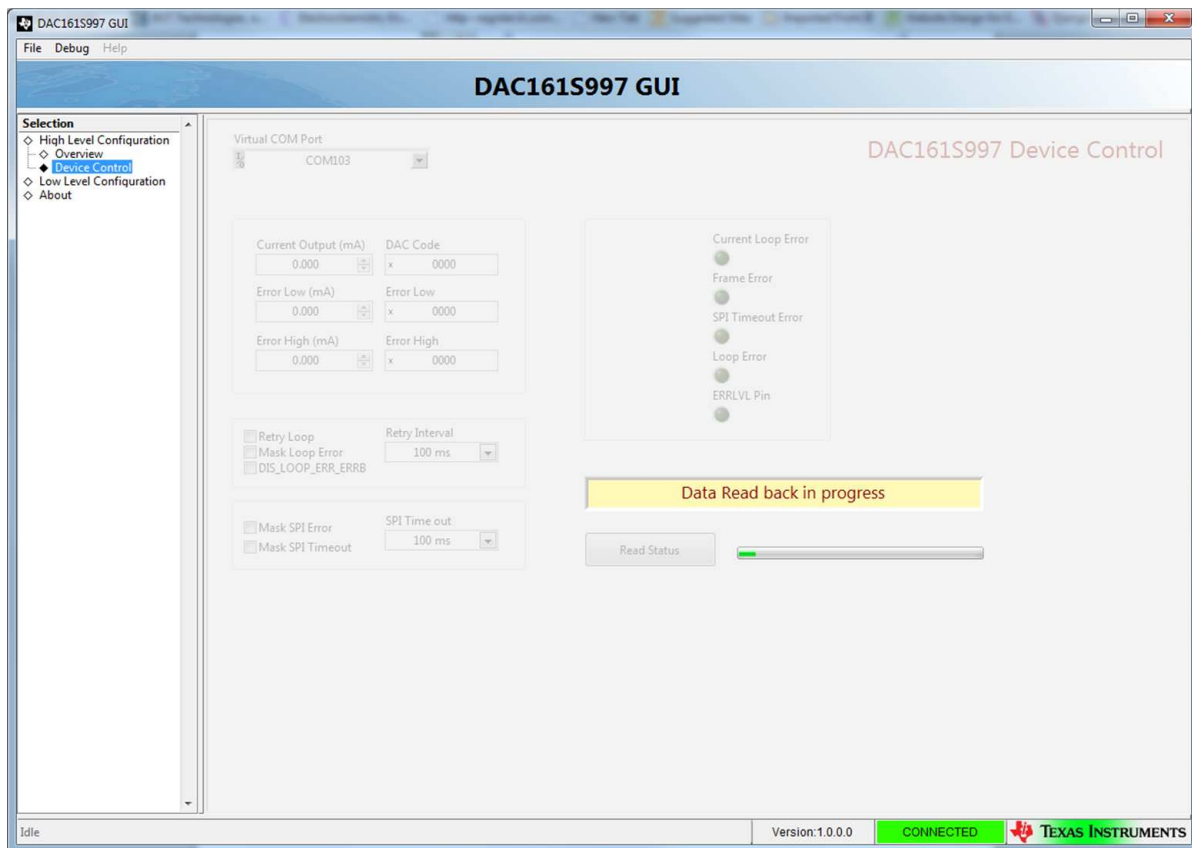

Figure 9.

- The DAC output current can be set in the Current Output field, and the Error current levels can also be set in the appropriate fields.
- Any error conditions are indicated and can be cleared when desired.
- Individual registers can be set directly if desired.



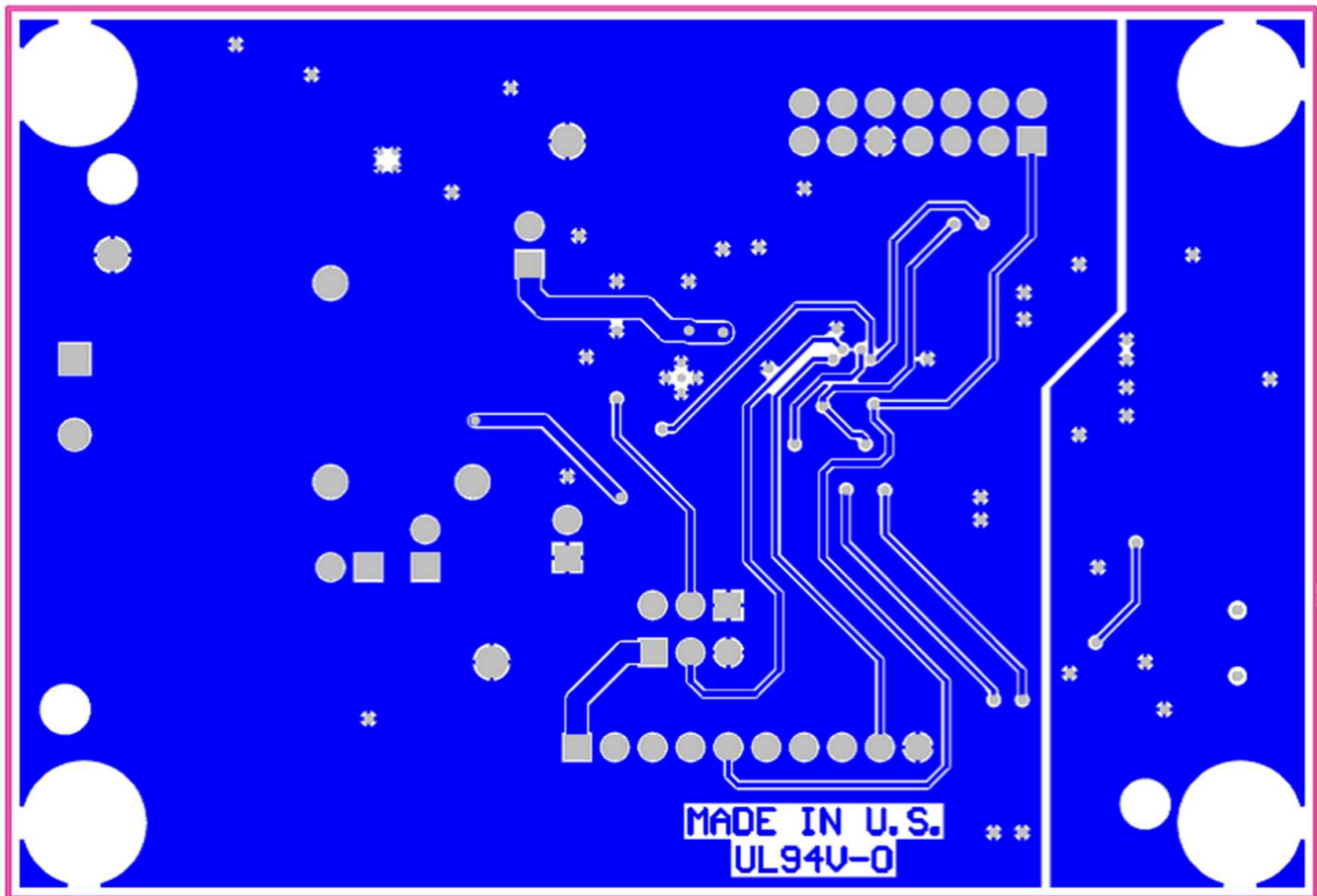

Figure 12. Bottom Layer Routing

5 Schematics

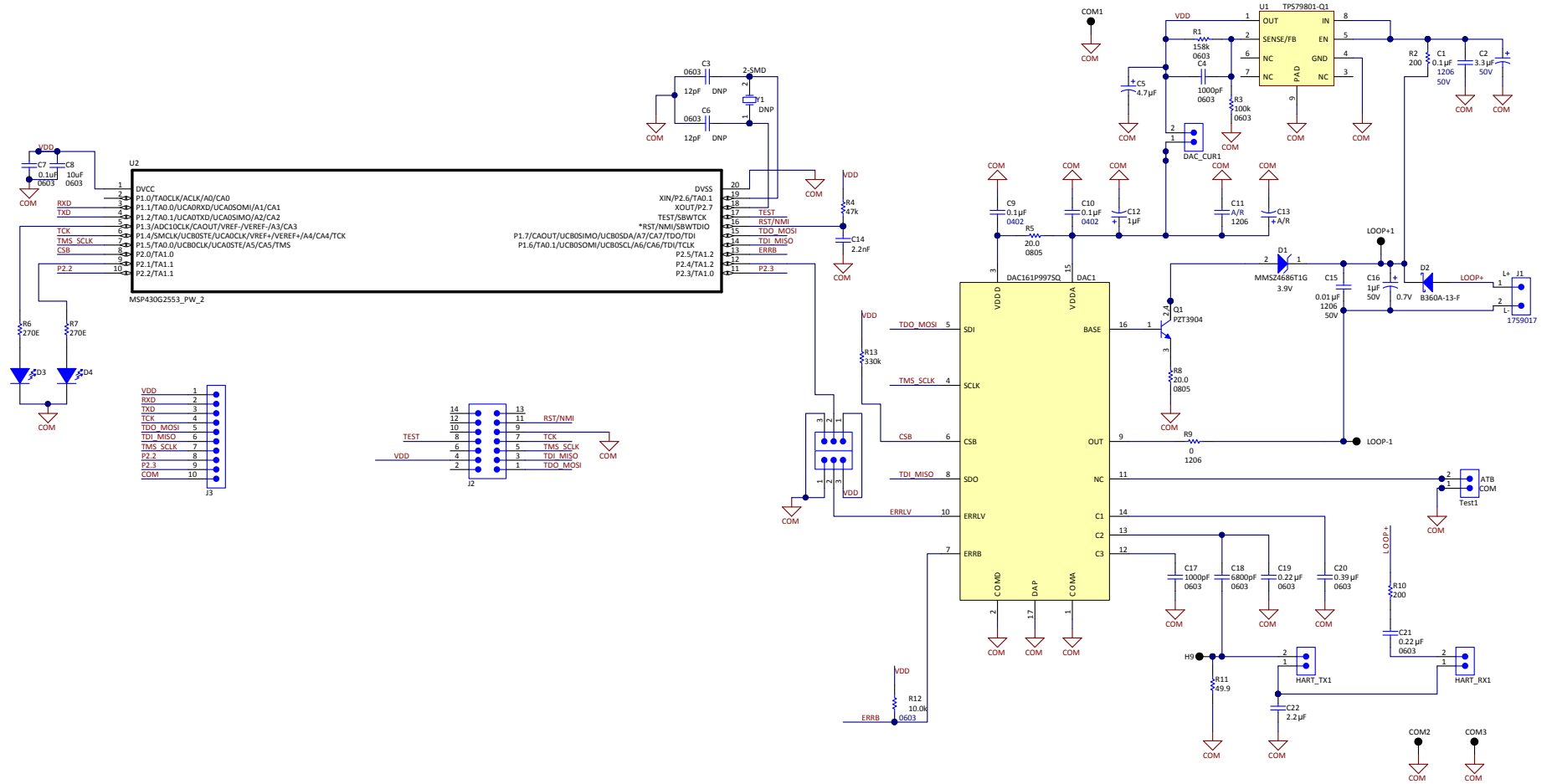
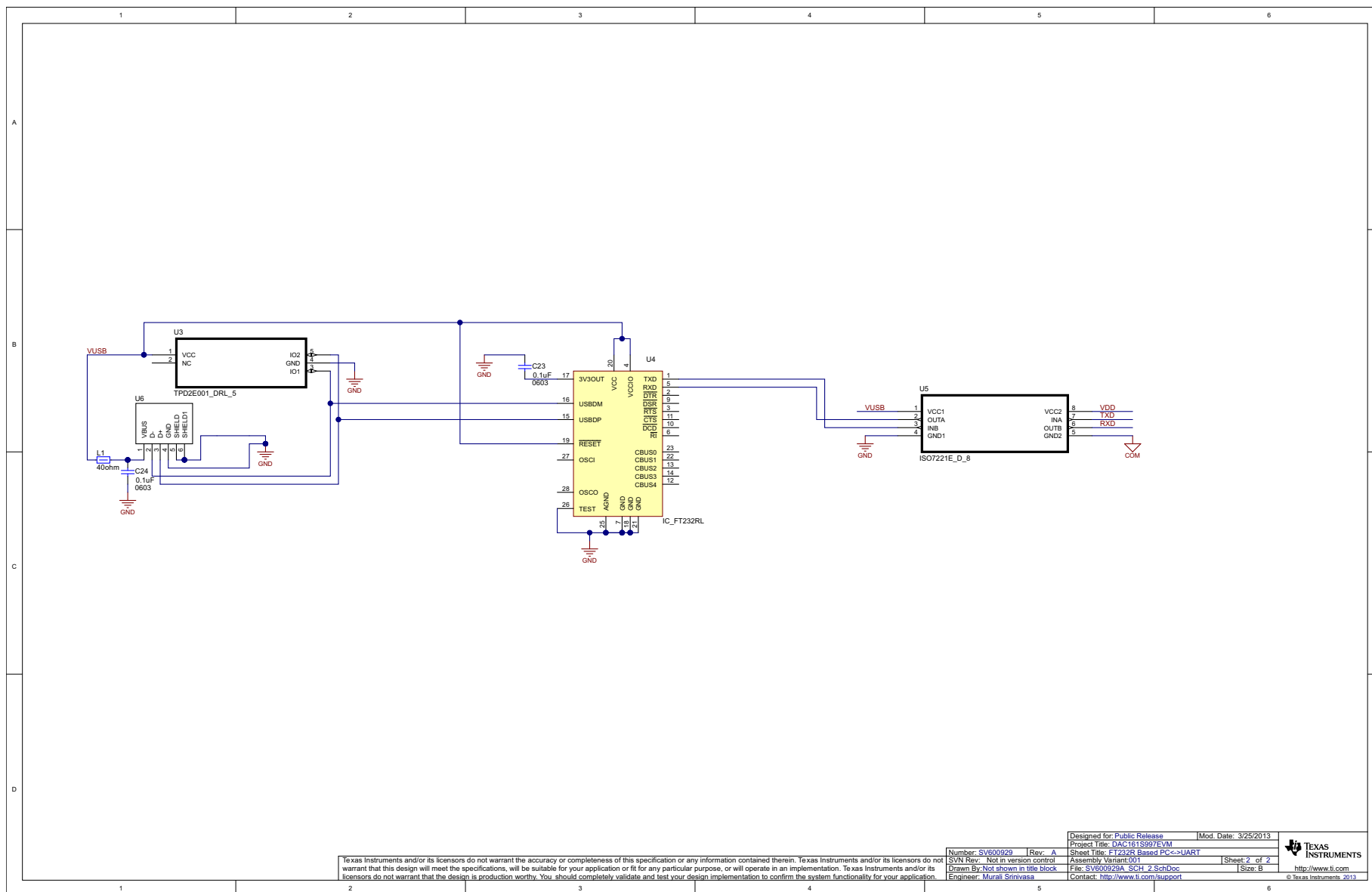

Figure 13. DAC161S997EVM Schematic



Texas Instruments and/or its licensors do not warrant the accuracy or completeness of this specification or any information contained therein. Texas Instruments and/or its licensors do not warrant that this design will meet the specifications, will be suitable for your application or fit for any particular purpose, or will operate in an implementation. Texas Instruments and/or its licensors do not warrant that the design is production worthy. You should completely validate and test your design implementation to confirm the system functionality for your application.

Designed for: Public Release		Mod. Date: 3/25/2013	
Project Title: DAC161S997EVM			
Number: SV600929		Rev: A	
SVN Rev: Not in version control		Sheet Title: FT232R Based FCC->UART	
Drawn By: Not shown in title block		Assembly Variant: 001	
Engineer: Murali Srinivasa		File: SV600929A_SCH_2_SchDoc	
		Sheet: 2 of 2	
		Size: B	
		http://www.ti.com	
		Contact: http://www.ti.com/support	
© Texas Instruments, 2013			

Figure 14. DAC161S997EVM Schematic

## 6 Bill of Materials

Designator	Quantity	Value	Description	Package Reference	Part Number
C1	1	0.1 $\mu$ F	CAP, CERM, 0.1uF, 50V, +/-5%, X7R, 1206	1206	C1206C104J5RACTU
C2	1	3.3 $\mu$ F	CAP, TANT, 3.3uF, 50V, +/-10%, 0.8 ohm, 7343-31 SMD	7343-31	TPSD335K050R0800
C4, C17	2	1000pF	CAP, CERM, 1000pF, 50V, +/-10%, COG/NP0, 0603	603	06035A102KAT2A
C5	1	4.7 $\mu$ F	CAP, TANT, 4.7uF, 10V, +/-10%, 1.4 ohm, 3216-18 SMD	3216-18	T495A475K010ZTE1K4
C7, C23, C24	3	0.1 $\mu$ F	CAP CER 0.1UF 10V 10% X7R 0603	603	C0603C104K8RACTU
C8	1	10 $\mu$ F	CAP CER 10UF 10V 10% X5R 0603	603	C1608X5R1A106K
C9, C10	2	0.1 $\mu$ F	CAP, CERM, 0.1uF, 10V, +/-10%, X5R, 0402	402	C1005X5R1A104K
C12, C16	2	1 $\mu$ F	CAP, TANT, 1uF, 50V, +/-10%, 4.6 ohm, 6032-28 SMD	6032-28	293D105X9050C2TE3
C13	1	3.3 $\mu$ F	CAP, TANT, 3.3uF, 16V, +/-10%, 3.5 ohm, 3216-18 SMD	3216-18	TPSA335K016R3500
C14	1	2.2nF	CAP CER 2200PF 10V 5% X7R 0603	603	C0603C222J8RACTU
C15	1	0.01 $\mu$ F	CAP, CERM, 0.01uF, 50V, +/-5%, COG/NP0, 1206	1206	C3216C0G1H103J
C18	1	6800pF	CAP, CERM, 6800pF, 50V, +/-5%, X7R, 0603	603	C0603C682J5RACTU
C19, C21	2	0.22 $\mu$ F	CAP, CERM, 0.22uF, 10V, +/-10%, X5R, 0603	603	C1608X5R1A224K
C20	1	0.39 $\mu$ F	CAP, CERM, 0.39uF, 10V, +/-10%, X5R, 0603	603	C0603C394K8PACTU
C22	1	2.2 $\mu$ F	CAP, CERM, 2.2uF, 100V, +/-10%, X7R, 1210	1210	HMK325B7225KN-T
COM1, COM2, COM3, H9, LOOP+1, LOOP-1	6	Black	Test Point, TH, Miniature, Black		5001
D1	1	3.9V	Diode, Zener, 3.9V, 500mW, SOD-123	SOD-123	MMSZ4686T1G
D2	1	0.7V	Diode, Schottky, 60V, 3A, SMA	SMA	B360A-13-F
D3	1		LED, [Color], [MountType]	603	LG L29K-G2J1-24-Z
D4	1		LED, [Color], [MountType]	603	SML-LX0603SRW-TR
DAC1	1		DAC161S997		DAC161P997SQ
DAC_CUR1, HART_RX1, HART_TX1, Test1	4		Header, TH, 100mil, 2x1, Gold plated, 230 mil above insulator		TSW-102-07-G-S
ERRLVL SEL1, ERRLVL SEL2	2		Header, TH, 100mil, 3x1, Gold plated, 230 mil above insulator		TSW-103-07-G-S
J1	1	250V	CONN HEADER RT ANG 2POS 5.08MM		1759017
J2	1		Header, TH, 100mil, 7x2, Gold plated, 230 mil above insulator		TSW-107-07-G-D
J3	1		Header, TH, 100mil, 10x1, Gold plated, 230 mil above insulator		TSW-110-07-G-S
L1	1	40 $\Omega$	1A Ferrite Bead, 2 ohm @ 100MHz, SMD	1206	MI0805K400R-10
Q1	1		TRANSISTOR GP NPN 40V SOT-223	SOT-223	PZT3904
R1	1	158k	RES, 158k ohm, 1%, 0.1W, 0603	603	CRCW0603158KFKEA

Designator	Quantity	Value	Description	Package Reference	Part Number
R2, R10	2	200Ω	RES, 200 ohm, 1%, 0.25W, 1206	1206	CRCW1206200RFKEA
R3	1	100k	RES, 100k ohm, 1%, 0.1W, 0603	603	CRCW0603100KFKEA
R4	1	47k	RES 47K OHM 1/10W 5% 0603 SMD	603	ERJ-3GEYJ473V
R5, R8	2	20.0Ω	RES, 20.0 ohm, 1%, 0.125W, 0805	805	CRCW080520R0FKEA
R6, R7	2	270E	RES 270 OHM 1/10W 5% 0603 SMD	603	ERJ-3GEYJ271V
R9	1	0	RES, 0 ohm, 5%, 0.25W, 1206	1206	CRCW12060000Z0EA
R11	1	49.9Ω	RES, 49.9 ohm, 1%, 0.25W, 1206	1206	CRCW120649R9FKEA
R12	1	10.0k	RES, 10.0k ohm, 1%, 0.1W, 0603	603	CRCW060310K0FKEA
R13	1	330k	RES, 330k ohm, 5%, 0.1W, 0603	603	CRCW0603330KJNEA
SH-J1, SH-J2	2	1x2	Shunt, 100mil, Gold plated, Black		382811-6
U1	1		50 mA, 3 V TO 50 V, MICROPOWER, LOW-DROPOUT LINEAR REGULATOR	MSOP8	TPS79801-Q1
U2	1		IC MCU 16BIT 16KB FLASH 20TSSOP		MSP430G2553IPW20R
U3	1		IC ESD-PROT ARRAY 2CH SOT-5		TPD2E001DRLR
U4	1		IC USB FS SERIAL UART 28-SSOP		FT232RL-REEL
U5	1		Low-Power Dual Channel Digital Isolators		ISO7421ED
U6	1		CONN COM TYPE B MINI USB SMD 5P		65100516121
Y1	1	DNP	CRYSTAL 12.000MHZ 12PF SMD	2-SMD	7A-12.000MAAE-T
C3, C6	0	12pF	DNP	603	C0603C120K5GACTU
C11	0	A/R	DNP	1206	DNP

## Revision History

NOTE: Page numbers for previous revisions may differ from page numbers in the current version.

<b>Changes from Original (June 2013) to A Revision</b>	<b>Page</b>
• Updated schematic .....	11

---

## STANDARD TERMS AND CONDITIONS FOR EVALUATION MODULES

1. *Delivery:* TI delivers TI evaluation boards, kits, or modules, including any accompanying demonstration software, components, or documentation (collectively, an "EVM" or "EVMs") to the User ("User") in accordance with the terms and conditions set forth herein. Acceptance of the EVM is expressly subject to the following terms and conditions.
  - 1.1 EVMs are intended solely for product or software developers for use in a research and development setting to facilitate feasibility evaluation, experimentation, or scientific analysis of TI semiconductor products. EVMs have no direct function and are not finished products. EVMs shall not be directly or indirectly assembled as a part or subassembly in any finished product. For clarification, any software or software tools provided with the EVM ("Software") shall not be subject to the terms and conditions set forth herein but rather shall be subject to the applicable terms and conditions that accompany such Software
  - 1.2 EVMs are not intended for consumer or household use. EVMs may not be sold, sublicensed, leased, rented, loaned, assigned, or otherwise distributed for commercial purposes by Users, in whole or in part, or used in any finished product or production system.
2. *Limited Warranty and Related Remedies/Disclaimers:*
  - 2.1 These terms and conditions do not apply to Software. The warranty, if any, for Software is covered in the applicable Software License Agreement.
  - 2.2 TI warrants that the TI EVM will conform to TI's published specifications for ninety (90) days after the date TI delivers such EVM to User. Notwithstanding the foregoing, TI shall not be liable for any defects that are caused by neglect, misuse or mistreatment by an entity other than TI, including improper installation or testing, or for any EVMs that have been altered or modified in any way by an entity other than TI. Moreover, TI shall not be liable for any defects that result from User's design, specifications or instructions for such EVMs. Testing and other quality control techniques are used to the extent TI deems necessary or as mandated by government requirements. TI does not test all parameters of each EVM.
  - 2.3 If any EVM fails to conform to the warranty set forth above, TI's sole liability shall be at its option to repair or replace such EVM, or credit User's account for such EVM. TI's liability under this warranty shall be limited to EVMs that are returned during the warranty period to the address designated by TI and that are determined by TI not to conform to such warranty. If TI elects to repair or replace such EVM, TI shall have a reasonable time to repair such EVM or provide replacements. Repaired EVMs shall be warranted for the remainder of the original warranty period. Replaced EVMs shall be warranted for a new full ninety (90) day warranty period.
3. *Regulatory Notices:*
  - 3.1 *United States*
    - 3.1.1 *Notice applicable to EVMs not FCC-Approved:*

This kit is designed to allow product developers to evaluate electronic components, circuitry, or software associated with the kit to determine whether to incorporate such items in a finished product and software developers to write software applications for use with the end product. This kit is not a finished product and when assembled may not be resold or otherwise marketed unless all required FCC equipment authorizations are first obtained. Operation is subject to the condition that this product not cause harmful interference to licensed radio stations and that this product accept harmful interference. Unless the assembled kit is designed to operate under part 15, part 18 or part 95 of this chapter, the operator of the kit must operate under the authority of an FCC license holder or must secure an experimental authorization under part 5 of this chapter.
    - 3.1.2 *For EVMs annotated as FCC – FEDERAL COMMUNICATIONS COMMISSION Part 15 Compliant:*

### CAUTION

This device complies with part 15 of the FCC Rules. Operation is subject to the following two conditions: (1) This device may not cause harmful interference, and (2) this device must accept any interference received, including interference that may cause undesired operation.

Changes or modifications not expressly approved by the party responsible for compliance could void the user's authority to operate the equipment.

### FCC Interference Statement for Class A EVM devices

*NOTE: This equipment has been tested and found to comply with the limits for a Class A digital device, pursuant to part 15 of the FCC Rules. These limits are designed to provide reasonable protection against harmful interference when the equipment is operated in a commercial environment. This equipment generates, uses, and can radiate radio frequency energy and, if not installed and used in accordance with the instruction manual, may cause harmful interference to radio communications. Operation of this equipment in a residential area is likely to cause harmful interference in which case the user will be required to correct the interference at his own expense.*

## FCC Interference Statement for Class B EVM devices

*NOTE: This equipment has been tested and found to comply with the limits for a Class B digital device, pursuant to part 15 of the FCC Rules. These limits are designed to provide reasonable protection against harmful interference in a residential installation. This equipment generates, uses and can radiate radio frequency energy and, if not installed and used in accordance with the instructions, may cause harmful interference to radio communications. However, there is no guarantee that interference will not occur in a particular installation. If this equipment does cause harmful interference to radio or television reception, which can be determined by turning the equipment off and on, the user is encouraged to try to correct the interference by one or more of the following measures:*

- Reorient or relocate the receiving antenna.
- Increase the separation between the equipment and receiver.
- Connect the equipment into an outlet on a circuit different from that to which the receiver is connected.
- Consult the dealer or an experienced radio/TV technician for help.

### 3.2 Canada

#### 3.2.1 For EVMs issued with an Industry Canada Certificate of Conformance to RSS-210

##### **Concerning EVMs Including Radio Transmitters:**

This device complies with Industry Canada license-exempt RSS standard(s). Operation is subject to the following two conditions: (1) this device may not cause interference, and (2) this device must accept any interference, including interference that may cause undesired operation of the device.

##### **Concernant les EVMs avec appareils radio:**

Le présent appareil est conforme aux CNR d'Industrie Canada applicables aux appareils radio exempts de licence. L'exploitation est autorisée aux deux conditions suivantes: (1) l'appareil ne doit pas produire de brouillage, et (2) l'utilisateur de l'appareil doit accepter tout brouillage radioélectrique subi, même si le brouillage est susceptible d'en compromettre le fonctionnement.

##### **Concerning EVMs Including Detachable Antennas:**

Under Industry Canada regulations, this radio transmitter may only operate using an antenna of a type and maximum (or lesser) gain approved for the transmitter by Industry Canada. To reduce potential radio interference to other users, the antenna type and its gain should be so chosen that the equivalent isotropically radiated power (e.i.r.p.) is not more than that necessary for successful communication. This radio transmitter has been approved by Industry Canada to operate with the antenna types listed in the user guide with the maximum permissible gain and required antenna impedance for each antenna type indicated. Antenna types not included in this list, having a gain greater than the maximum gain indicated for that type, are strictly prohibited for use with this device.

##### **Concernant les EVMs avec antennes détachables**

Conformément à la réglementation d'Industrie Canada, le présent émetteur radio peut fonctionner avec une antenne d'un type et d'un gain maximal (ou inférieur) approuvé pour l'émetteur par Industrie Canada. Dans le but de réduire les risques de brouillage radioélectrique à l'intention des autres utilisateurs, il faut choisir le type d'antenne et son gain de sorte que la puissance isotrope rayonnée équivalente (p.i.r.e.) ne dépasse pas l'intensité nécessaire à l'établissement d'une communication satisfaisante. Le présent émetteur radio a été approuvé par Industrie Canada pour fonctionner avec les types d'antenne énumérés dans le manuel d'usage et ayant un gain admissible maximal et l'impédance requise pour chaque type d'antenne. Les types d'antenne non inclus dans cette liste, ou dont le gain est supérieur au gain maximal indiqué, sont strictement interdits pour l'exploitation de l'émetteur.

### 3.3 Japan

3.3.1 *Notice for EVMs delivered in Japan:* Please see [http://www.tij.co.jp/lstds/ti\\_ja/general/eStore/notice\\_01.page](http://www.tij.co.jp/lstds/ti_ja/general/eStore/notice_01.page) 日本国内に輸入される評価用キット、ボードについては、次のところをご覧ください。  
[http://www.tij.co.jp/lstds/ti\\_ja/general/eStore/notice\\_01.page](http://www.tij.co.jp/lstds/ti_ja/general/eStore/notice_01.page)

3.3.2 *Notice for Users of EVMs Considered "Radio Frequency Products" in Japan:* EVMs entering Japan may not be certified by TI as conforming to Technical Regulations of Radio Law of Japan.

If User uses EVMs in Japan, not certified to Technical Regulations of Radio Law of Japan, User is required by Radio Law of Japan to follow the instructions below with respect to EVMs:

1. Use EVMs in a shielded room or any other test facility as defined in the notification #173 issued by Ministry of Internal Affairs and Communications on March 28, 2006, based on Sub-section 1.1 of Article 6 of the Ministry's Rule for Enforcement of Radio Law of Japan,
2. Use EVMs only after User obtains the license of Test Radio Station as provided in Radio Law of Japan with respect to EVMs, or
3. Use of EVMs only after User obtains the Technical Regulations Conformity Certification as provided in Radio Law of Japan with respect to EVMs. Also, do not transfer EVMs, unless User gives the same notice above to the transferee. Please note that if User does not follow the instructions above, User will be subject to penalties of Radio Law of Japan.

【無線電波を送信する製品の開発キットをお使いになる際の注意事項】 開発キットの中には技術基準適合証明を受けていないものがあります。技術適合証明を受けていないもののご使用に際しては、電波法遵守のため、以下のいずれかの措置を取っていただく必要がありますのでご注意ください。

1. 電波法施行規則第6条第1項第1号に基づく平成18年3月28日総務省告示第173号で定められた電波暗室等の試験設備でご使用いただく。
2. 実験局の免許を取得後ご使用いただく。
3. 技術基準適合証明を取得後ご使用いただく。

なお、本製品は、上記の「ご使用にあたっての注意」を譲渡先、移転先に通知しない限り、譲渡、移転できないものとします。

上記を遵守頂けない場合は、電波法の罰則が適用される可能性があることをご留意ください。日本テキサス・インスツルメンツ株式会社  
東京都新宿区西新宿 6 丁目 2 4 番 1 号  
西新宿三井ビル

3.3.3 *Notice for EVMs for Power Line Communication:* Please see [http://www.tij.co.jp/llds/ti\\_ja/general/eStore/notice\\_02.page](http://www.tij.co.jp/llds/ti_ja/general/eStore/notice_02.page)  
電力線搬送波通信についての開発キットをお使いになる際の注意事項については、次のところをご覧ください。[http://www.tij.co.jp/llds/ti\\_ja/general/eStore/notice\\_02.page](http://www.tij.co.jp/llds/ti_ja/general/eStore/notice_02.page)

#### 4 *EVM Use Restrictions and Warnings:*

4.1 EVMS ARE NOT FOR USE IN FUNCTIONAL SAFETY AND/OR SAFETY CRITICAL EVALUATIONS, INCLUDING BUT NOT LIMITED TO EVALUATIONS OF LIFE SUPPORT APPLICATIONS.

4.2 User must read and apply the user guide and other available documentation provided by TI regarding the EVM prior to handling or using the EVM, including without limitation any warning or restriction notices. The notices contain important safety information related to, for example, temperatures and voltages.

#### 4.3 *Safety-Related Warnings and Restrictions:*

4.3.1 User shall operate the EVM within TI's recommended specifications and environmental considerations stated in the user guide, other available documentation provided by TI, and any other applicable requirements and employ reasonable and customary safeguards. Exceeding the specified performance ratings and specifications (including but not limited to input and output voltage, current, power, and environmental ranges) for the EVM may cause personal injury or death, or property damage. If there are questions concerning performance ratings and specifications, User should contact a TI field representative prior to connecting interface electronics including input power and intended loads. Any loads applied outside of the specified output range may also result in unintended and/or inaccurate operation and/or possible permanent damage to the EVM and/or interface electronics. Please consult the EVM user guide prior to connecting any load to the EVM output. If there is uncertainty as to the load specification, please contact a TI field representative. During normal operation, even with the inputs and outputs kept within the specified allowable ranges, some circuit components may have elevated case temperatures. These components include but are not limited to linear regulators, switching transistors, pass transistors, current sense resistors, and heat sinks, which can be identified using the information in the associated documentation. When working with the EVM, please be aware that the EVM may become very warm.

4.3.2 EVMs are intended solely for use by technically qualified, professional electronics experts who are familiar with the dangers and application risks associated with handling electrical mechanical components, systems, and subsystems. User assumes all responsibility and liability for proper and safe handling and use of the EVM by User or its employees, affiliates, contractors or designees. User assumes all responsibility and liability to ensure that any interfaces (electronic and/or mechanical) between the EVM and any human body are designed with suitable isolation and means to safely limit accessible leakage currents to minimize the risk of electrical shock hazard. User assumes all responsibility and liability for any improper or unsafe handling or use of the EVM by User or its employees, affiliates, contractors or designees.

4.4 User assumes all responsibility and liability to determine whether the EVM is subject to any applicable international, federal, state, or local laws and regulations related to User's handling and use of the EVM and, if applicable, User assumes all responsibility and liability for compliance in all respects with such laws and regulations. User assumes all responsibility and liability for proper disposal and recycling of the EVM consistent with all applicable international, federal, state, and local requirements.

5. *Accuracy of Information:* To the extent TI provides information on the availability and function of EVMs, TI attempts to be as accurate as possible. However, TI does not warrant the accuracy of EVM descriptions, EVM availability or other information on its websites as accurate, complete, reliable, current, or error-free.

6. *Disclaimers:*

6.1 EXCEPT AS SET FORTH ABOVE, EVMS AND ANY WRITTEN DESIGN MATERIALS PROVIDED WITH THE EVM (AND THE DESIGN OF THE EVM ITSELF) ARE PROVIDED "AS IS" AND "WITH ALL FAULTS." TI DISCLAIMS ALL OTHER WARRANTIES, EXPRESS OR IMPLIED, REGARDING SUCH ITEMS, INCLUDING BUT NOT LIMITED TO ANY IMPLIED WARRANTIES OF MERCHANTABILITY OR FITNESS FOR A PARTICULAR PURPOSE OR NON-INFRINGEMENT OF ANY THIRD PARTY PATENTS, COPYRIGHTS, TRADE SECRETS OR OTHER INTELLECTUAL PROPERTY RIGHTS.

6.2 EXCEPT FOR THE LIMITED RIGHT TO USE THE EVM SET FORTH HEREIN, NOTHING IN THESE TERMS AND CONDITIONS SHALL BE CONSTRUED AS GRANTING OR CONFERRING ANY RIGHTS BY LICENSE, PATENT, OR ANY OTHER INDUSTRIAL OR INTELLECTUAL PROPERTY RIGHT OF TI, ITS SUPPLIERS/LICENSORS OR ANY OTHER THIRD PARTY, TO USE THE EVM IN ANY FINISHED END-USER OR READY-TO-USE FINAL PRODUCT, OR FOR ANY INVENTION, DISCOVERY OR IMPROVEMENT MADE, CONCEIVED OR ACQUIRED PRIOR TO OR AFTER DELIVERY OF THE EVM.

7. *USER'S INDEMNITY OBLIGATIONS AND REPRESENTATIONS.* USER WILL DEFEND, INDEMNIFY AND HOLD TI, ITS LICENSORS AND THEIR REPRESENTATIVES HARMLESS FROM AND AGAINST ANY AND ALL CLAIMS, DAMAGES, LOSSES, EXPENSES, COSTS AND LIABILITIES (COLLECTIVELY, "CLAIMS") ARISING OUT OF OR IN CONNECTION WITH ANY HANDLING OR USE OF THE EVM THAT IS NOT IN ACCORDANCE WITH THESE TERMS AND CONDITIONS. THIS OBLIGATION SHALL APPLY WHETHER CLAIMS ARISE UNDER STATUTE, REGULATION, OR THE LAW OF TORT, CONTRACT OR ANY OTHER LEGAL THEORY, AND EVEN IF THE EVM FAILS TO PERFORM AS DESCRIBED OR EXPECTED.

8. *Limitations on Damages and Liability:*

8.1 *General Limitations.* IN NO EVENT SHALL TI BE LIABLE FOR ANY SPECIAL, COLLATERAL, INDIRECT, PUNITIVE, INCIDENTAL, CONSEQUENTIAL, OR EXEMPLARY DAMAGES IN CONNECTION WITH OR ARISING OUT OF THESE TERMS AND CONDITIONS OR THE USE OF THE EVMS PROVIDED HEREUNDER, REGARDLESS OF WHETHER TI HAS BEEN ADVISED OF THE POSSIBILITY OF SUCH DAMAGES. EXCLUDED DAMAGES INCLUDE, BUT ARE NOT LIMITED TO, COST OF REMOVAL OR REINSTALLATION, ANCILLARY COSTS TO THE PROCUREMENT OF SUBSTITUTE GOODS OR SERVICES, RETESTING, OUTSIDE COMPUTER TIME, LABOR COSTS, LOSS OF GOODWILL, LOSS OF PROFITS, LOSS OF SAVINGS, LOSS OF USE, LOSS OF DATA, OR BUSINESS INTERRUPTION. NO CLAIM, SUIT OR ACTION SHALL BE BROUGHT AGAINST TI MORE THAN ONE YEAR AFTER THE RELATED CAUSE OF ACTION HAS OCCURRED.

8.2 *Specific Limitations.* IN NO EVENT SHALL TI'S AGGREGATE LIABILITY FROM ANY WARRANTY OR OTHER OBLIGATION ARISING OUT OF OR IN CONNECTION WITH THESE TERMS AND CONDITIONS, OR ANY USE OF ANY TI EVM PROVIDED HEREUNDER, EXCEED THE TOTAL AMOUNT PAID TO TI FOR THE PARTICULAR UNITS SOLD UNDER THESE TERMS AND CONDITIONS WITH RESPECT TO WHICH LOSSES OR DAMAGES ARE CLAIMED. THE EXISTENCE OF MORE THAN ONE CLAIM AGAINST THE PARTICULAR UNITS SOLD TO USER UNDER THESE TERMS AND CONDITIONS SHALL NOT ENLARGE OR EXTEND THIS LIMIT.

9. *Return Policy.* Except as otherwise provided, TI does not offer any refunds, returns, or exchanges. Furthermore, no return of EVM(s) will be accepted if the package has been opened and no return of the EVM(s) will be accepted if they are damaged or otherwise not in a resalable condition. If User feels it has been incorrectly charged for the EVM(s) it ordered or that delivery violates the applicable order, User should contact TI. All refunds will be made in full within thirty (30) working days from the return of the components(s), excluding any postage or packaging costs.

10. *Governing Law:* These terms and conditions shall be governed by and interpreted in accordance with the laws of the State of Texas, without reference to conflict-of-laws principles. User agrees that non-exclusive jurisdiction for any dispute arising out of or relating to these terms and conditions lies within courts located in the State of Texas and consents to venue in Dallas County, Texas. Notwithstanding the foregoing, any judgment may be enforced in any United States or foreign court, and TI may seek injunctive relief in any United States or foreign court.

## IMPORTANT NOTICE

Texas Instruments Incorporated and its subsidiaries (TI) reserve the right to make corrections, enhancements, improvements and other changes to its semiconductor products and services per JESD46, latest issue, and to discontinue any product or service per JESD48, latest issue. Buyers should obtain the latest relevant information before placing orders and should verify that such information is current and complete. All semiconductor products (also referred to herein as "components") are sold subject to TI's terms and conditions of sale supplied at the time of order acknowledgment.

TI warrants performance of its components to the specifications applicable at the time of sale, in accordance with the warranty in TI's terms and conditions of sale of semiconductor products. Testing and other quality control techniques are used to the extent TI deems necessary to support this warranty. Except where mandated by applicable law, testing of all parameters of each component is not necessarily performed.

TI assumes no liability for applications assistance or the design of Buyers' products. Buyers are responsible for their products and applications using TI components. To minimize the risks associated with Buyers' products and applications, Buyers should provide adequate design and operating safeguards.

TI does not warrant or represent that any license, either express or implied, is granted under any patent right, copyright, mask work right, or other intellectual property right relating to any combination, machine, or process in which TI components or services are used. Information published by TI regarding third-party products or services does not constitute a license to use such products or services or a warranty or endorsement thereof. Use of such information may require a license from a third party under the patents or other intellectual property of the third party, or a license from TI under the patents or other intellectual property of TI.

Reproduction of significant portions of TI information in TI data books or data sheets is permissible only if reproduction is without alteration and is accompanied by all associated warranties, conditions, limitations, and notices. TI is not responsible or liable for such altered documentation. Information of third parties may be subject to additional restrictions.

Resale of TI components or services with statements different from or beyond the parameters stated by TI for that component or service voids all express and any implied warranties for the associated TI component or service and is an unfair and deceptive business practice. TI is not responsible or liable for any such statements.

Buyer acknowledges and agrees that it is solely responsible for compliance with all legal, regulatory and safety-related requirements concerning its products, and any use of TI components in its applications, notwithstanding any applications-related information or support that may be provided by TI. Buyer represents and agrees that it has all the necessary expertise to create and implement safeguards which anticipate dangerous consequences of failures, monitor failures and their consequences, lessen the likelihood of failures that might cause harm and take appropriate remedial actions. Buyer will fully indemnify TI and its representatives against any damages arising out of the use of any TI components in safety-critical applications.

In some cases, TI components may be promoted specifically to facilitate safety-related applications. With such components, TI's goal is to help enable customers to design and create their own end-product solutions that meet applicable functional safety standards and requirements. Nonetheless, such components are subject to these terms.

No TI components are authorized for use in FDA Class III (or similar life-critical medical equipment) unless authorized officers of the parties have executed a special agreement specifically governing such use.

Only those TI components which TI has specifically designated as military grade or "enhanced plastic" are designed and intended for use in military/aerospace applications or environments. Buyer acknowledges and agrees that any military or aerospace use of TI components which have **not** been so designated is solely at the Buyer's risk, and that Buyer is solely responsible for compliance with all legal and regulatory requirements in connection with such use.

TI has specifically designated certain components as meeting ISO/TS16949 requirements, mainly for automotive use. In any case of use of non-designated products, TI will not be responsible for any failure to meet ISO/TS16949.

### Products

Audio	<a href="http://www.ti.com/audio">www.ti.com/audio</a>
Amplifiers	<a href="http://amplifier.ti.com">amplifier.ti.com</a>
Data Converters	<a href="http://dataconverter.ti.com">dataconverter.ti.com</a>
DLP® Products	<a href="http://www.dlp.com">www.dlp.com</a>
DSP	<a href="http://dsp.ti.com">dsp.ti.com</a>
Clocks and Timers	<a href="http://www.ti.com/clocks">www.ti.com/clocks</a>
Interface	<a href="http://interface.ti.com">interface.ti.com</a>
Logic	<a href="http://logic.ti.com">logic.ti.com</a>
Power Mgmt	<a href="http://power.ti.com">power.ti.com</a>
Microcontrollers	<a href="http://microcontroller.ti.com">microcontroller.ti.com</a>
RFID	<a href="http://www.ti-rfid.com">www.ti-rfid.com</a>
OMAP Applications Processors	<a href="http://www.ti.com/omap">www.ti.com/omap</a>
Wireless Connectivity	<a href="http://www.ti.com/wirelessconnectivity">www.ti.com/wirelessconnectivity</a>

### Applications

Automotive and Transportation	<a href="http://www.ti.com/automotive">www.ti.com/automotive</a>
Communications and Telecom	<a href="http://www.ti.com/communications">www.ti.com/communications</a>
Computers and Peripherals	<a href="http://www.ti.com/computers">www.ti.com/computers</a>
Consumer Electronics	<a href="http://www.ti.com/consumer-apps">www.ti.com/consumer-apps</a>
Energy and Lighting	<a href="http://www.ti.com/energy">www.ti.com/energy</a>
Industrial	<a href="http://www.ti.com/industrial">www.ti.com/industrial</a>
Medical	<a href="http://www.ti.com/medical">www.ti.com/medical</a>
Security	<a href="http://www.ti.com/security">www.ti.com/security</a>
Space, Avionics and Defense	<a href="http://www.ti.com/space-avionics-defense">www.ti.com/space-avionics-defense</a>
Video and Imaging	<a href="http://www.ti.com/video">www.ti.com/video</a>

### TI E2E Community

[e2e.ti.com](http://e2e.ti.com)

## Looking for pricing, stock, or lifecycle information?

Click below to explore more details on WIN SOURCE:

 [View DAC161S997EVM on WIN SOURCE](#)

 [Texas Instruments](#) Information

## Optimize Your Supply Chain with WIN SOURCE Solutions

-  Global Sourcing Solution
-  Obsolete Management
-  Cost Control Management
-  Shortage Management
-  Alternative Solution
-  Excess Inventory Management