

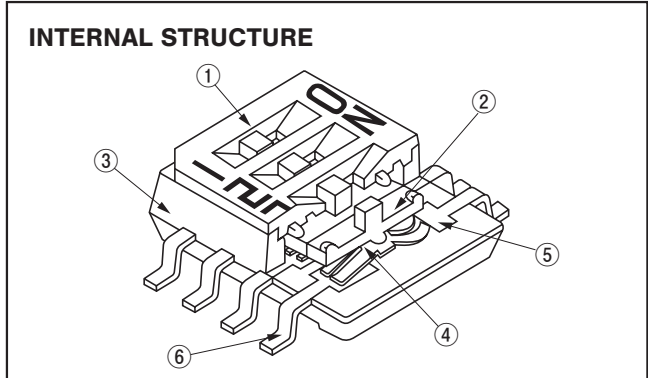

THE DATASHEET OF CHS-04TA

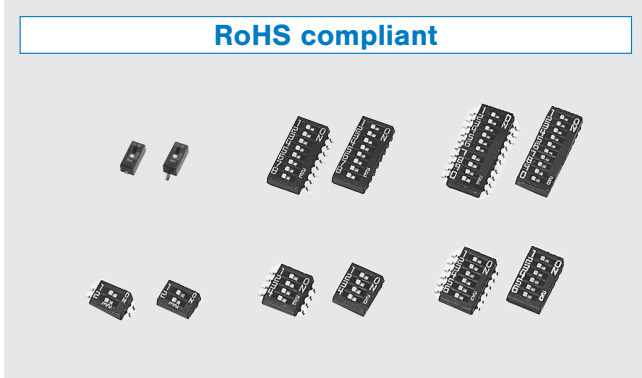

SLIDE SWITCHES (HALF PITCH)



FEATURES

- RoHS compliant
- Meets EIAJ SOP standard outline dimensions (B type)
- Low profile design of 2.5 mm
- 12 types of 1, 2, 4, 6, 8 or 10 bit with either gull wing or J-hook available
- Excellent contact stability by twin Gold-plated contact
- Resin material is UL Recognized 94V-0

Part name		Material
①	Cover	Polyphenylenesulfide
②	Slider	Polyamide
③	Housing	Polyphenylenesulfide
④	Slider contact	Copper alloy, Gold-plated
⑤	Fixed contact	
⑥	Terminal pin	

PART NUMBER DESIGNATION

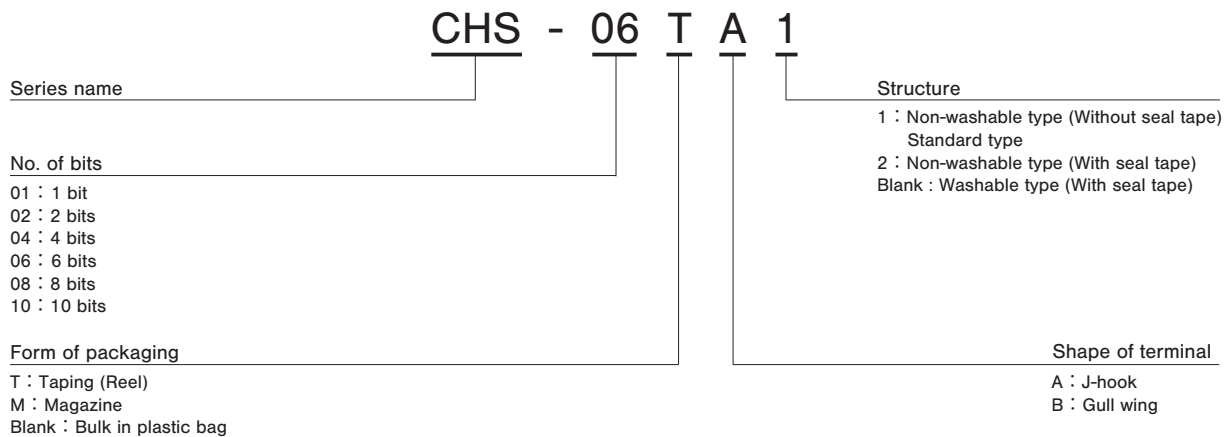

※ Please refer to the LIST OF PART NUMBERS when placing orders.

LIST OF PART NUMBERS

No. of bits	Form of packaging	Shape of terminals	Non-washable type (Without seal tape)				Non-washable type (With seal tape)				Packaging quantity
			A	J-hook	B	Gull wing	A	J-hook	B	Gull wing	
1	Taping		CHS-01TA1		CHS-01TB1		CHS-01TA2		CHS-01TB2	1000 pcs./reel	
	Magazine										
	Plastic bag		CHS-01A1		CHS-01B1					50 pcs./pack	
2	Taping		CHS-02TA1		CHS-02TB1		CHS-02TA2		CHS-02TB2	500 pcs./reel	
	Magazine										
	Plastic bag		CHS-02A1		CHS-02B1					50 pcs./pack	
4	Taping		CHS-04TA1		CHS-04TB1		CHS-04TA2		CHS-04TB2	500 pcs./reel	
	Magazine		CHS-04MA1		CHS-04MB1					70 pcs./stick	
	Plastic bag		CHS-04A1		CHS-04B1					50 pcs./pack	
6	Taping		CHS-06TA1		CHS-06TB1		CHS-06TA2		CHS-06TB2	500 pcs./reel	
	Magazine		CHS-06MA1		CHS-06MB1					50 pcs./stick	
	Plastic bag		CHS-06A1		CHS-06B1					50 pcs./pack	
8	Taping		CHS-08TA1		CHS-08TB1		CHS-08TA2		CHS-08TB2	500 pcs./reel	
	Magazine		CHS-08MA1		CHS-08MB1					40 pcs./stick	
	Plastic bag		CHS-08A1		CHS-08B1					50 pcs./pack	
10	Taping		CHS-10TA1		CHS-10TB1		CHS-10TA2		CHS-10TB2	500 pcs./ree	
	Magazine		CHS-10MA1		CHS-10MB1					30 pcs./stick	
	Plastic bag		CHS-10A1		CHS-10B1					50 pcs./pack	

No. of bits	Form of packaging	Shape of terminals	Washable type (With seal tape)				Packaging quantity
			A	J-hook	B	Gull wing	
1	Taping		CHS-01TA		CHS-01TB	1000 pcs./reel	
	Magazine						
	Plastic bag		CHS-01A		CHS-01B	50 pcs./pack	
2	Taping		CHS-02TA		CHS-02TB	500 pcs./reel	
	Magazine						
	Plastic bag		CHS-02A		CHS-02B	50 pcs./pack	
4	Taping		CHS-04TA		CHS-04TB	500 pcs./reel	
	Magazine		CHS-04MA		CHS-04MB	70 pcs./stick	
	Plastic bag		CHS-04A		CHS-04B	50 pcs./pack	
6	Taping		CHS-06TA		CHS-06TB	500 pcs./reel	
	Magazine		CHS-06MA		CHS-06MB	50 pcs./stick	
	Plastic bag		CHS-06A		CHS-06B	50 pcs./pack	
8	Taping		CHS-08TA		CHS-08TB	500 pcs./reel	
	Magazine		CHS-08MA		CHS-08MB	40 pcs./stick	
	Plastic bag		CHS-08A		CHS-08B	50 pcs./pack	
10	Taping		CHS-10TA		CHS-10TB	500 pcs./ree	
	Magazine		CHS-10MA		CHS-10MB	30 pcs./stick	
	Plastic bag		CHS-10A		CHS-10B	50 pcs./pack	

☐ : Not manufactured

※ Verify the above part numbers when placing orders.

Taping and magazine version can be supplied only in reel or stick units.

STANDARD SPECIFICATIONS

Operating temp. range	- 40 ~ 85 °C
Storage temp. range	
Sealing	Washable type available with seal tape
Net weight	Approx. 0.05 g (CHS-01) Approx. 0.08 g (CHS-02) Approx. 0.12 g (CHS-04) Approx. 0.17 g (CHS-06) Approx. 0.22 g (CHS-08) Approx. 0.25 g (CHS-10)

ELECTRICAL CHARACTERISTICS

Contact rating Non-switching Switching Minimum	DC50 V, 100 mA DC6 V, 100 mA DC24 V, 25 mA DC20 mV 1 μA
Contact resistance	50 mΩ maximum
Insulation resistance	1000 MΩ (DC100 V) minimum
Dielectric strength	AC500 V, 60 s

MECHANICAL CHARACTERISTICS

Operating force	0.5 ~ 5 N {0.05 ~ 0.51 kgf}
Stop strength	10 N {1.02 kgf}, 60 s
Solderability	245 ± 3 °C, 2 ~ 3 s
Soldering heat	Reflow : 255 °C (Peak temperature) (Please refer to the profile below)
	Manual soldering : 350 ± 10 °C, 3 ~ 4 s
Shear (Adhesion)	5 N {0.51 kgf} 10 s
Substrate bending	Width 90 mm, bend 3 mm, 5 s, 1 time
Pull-off strength	5 N {0.51 kgf} 10 s

{ } : Reference only

ENVIRONMENTAL CHARACTERISTICS

Vibration	(Amplitude) 1.5 mm or (Acceleration) 98 m/s ² , 10-500 Hz, 3 directions for 10 cycles each
Shock	490 m/s ² , 11 ms 6 directions for 3 times each
Load life	Continuous load 2000 cycles, DC6 ± 0.5 V, 100 ± 10 mA
Humidity	-10 ~ 65 °C, Relative humidity 0 ~ 96 %, 24 h for 10 cycles
High temp. exposure	85 °C, 96 h
Low temp. exposure	-40 °C, 96 h
Thermal shock	-40 (0.5 h) ~ 85 °C (0.5 h), 5 cycles

<Reflow profile for soldering heat evaluation>

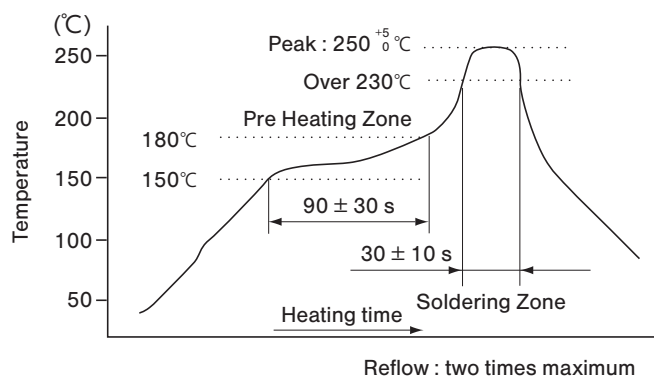

CHS

SLIDE SWITCHES (HALF PITCH)

OUTLINE DIMENSIONS

Unless otherwise specified, tolerance : ± 0.3 (Unit : mm)

CHS-01A1 Non-washable type (Without seal tape)

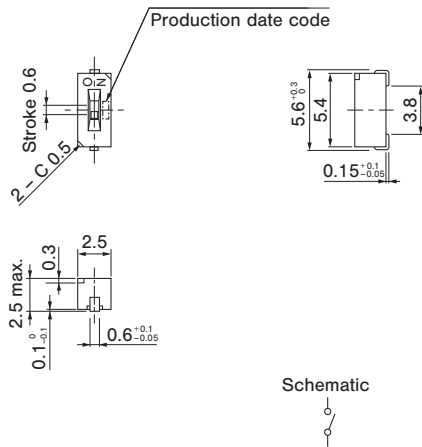

CHS-01B1 Non-washable type (Without seal tape)

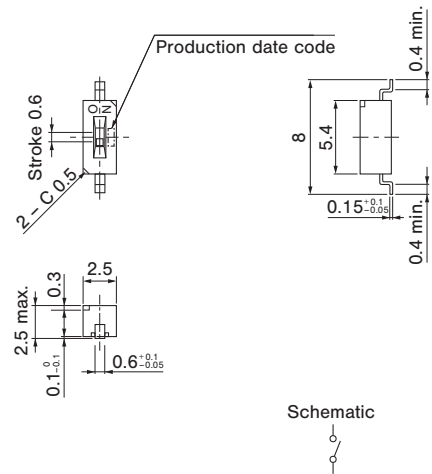

CHS-02A1 Non-washable type (Without seal tape)

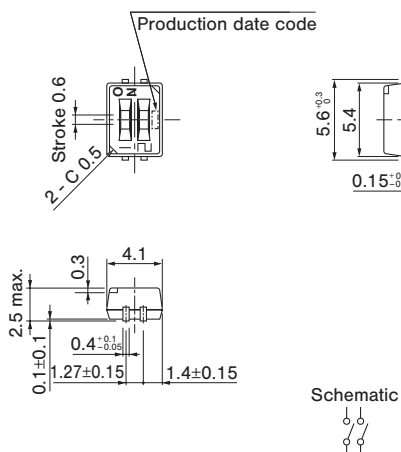

CHS-02B1 (In accordance with EIAJ ED-7402-1) Non-washable type (Without seal tape)

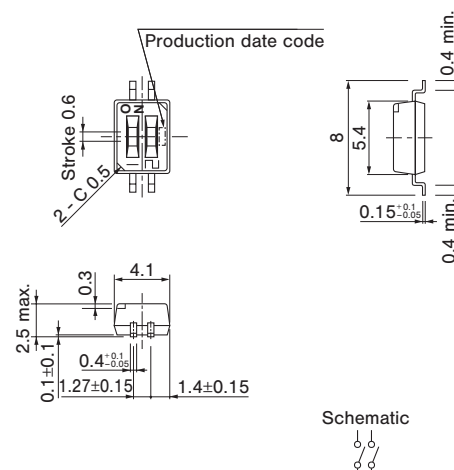

OUTLINE DIMENSIONS

Unless otherwise specified, tolerance : ± 0.3 (Unit : mm)

● CHS-04A1 Non-washable type (Without seal tape)

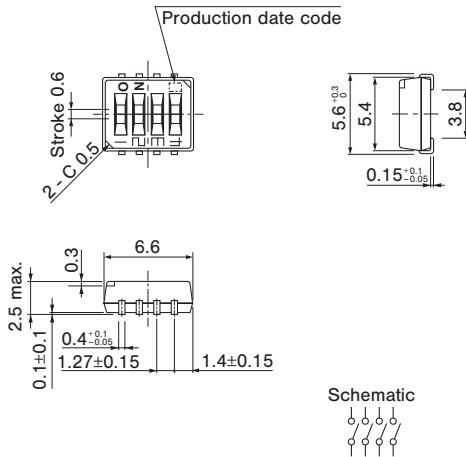

● CHS-04B1 (In accordance with EIAJ ED-7402-1) Non-washable type (Without seal tape)

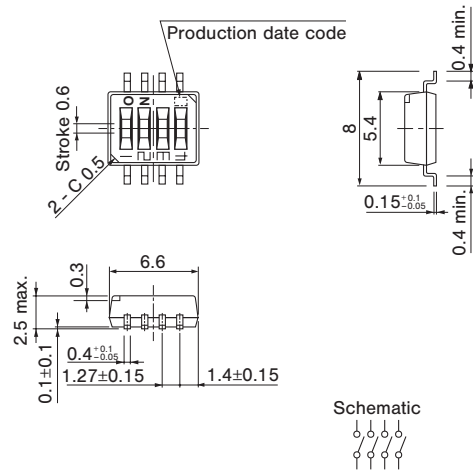

● CHS-06A1 Non-washable type (Without seal tape)

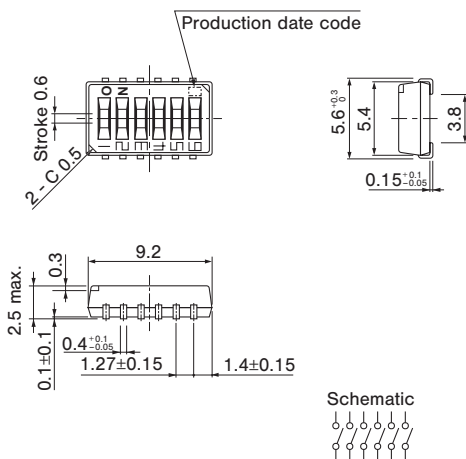

● CHS-06B1 (In accordance with EIAJ ED-7402-1) Non-washable type (Without seal tape)

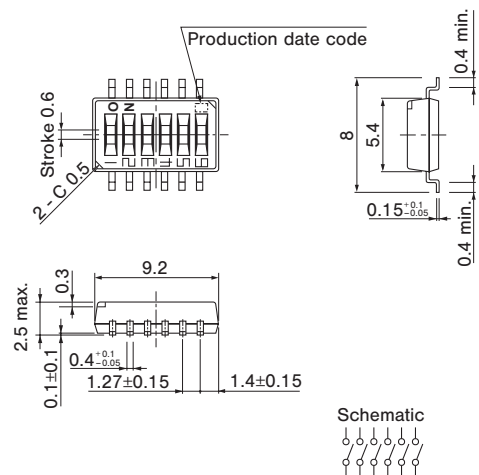

CHS

SLIDE SWITCHES (HALF PITCH)

OUTLINE DIMENSIONS

Unless otherwise specified, tolerance : ± 0.3 (Unit : mm)

CHS-08A1 Non-washable type (Without seal tape)

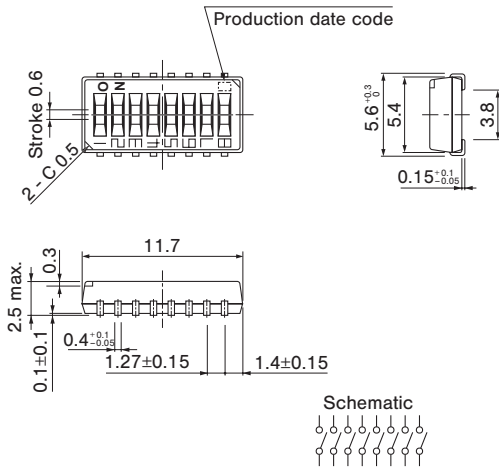

CHS-08B1 (In accordance with EIAJ ED-7402-1) Non-washable type (Without seal tape)

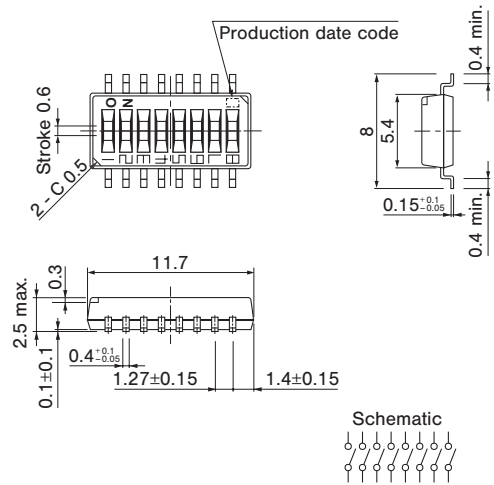

CHS-10A1 Non-washable type (Without seal tape)

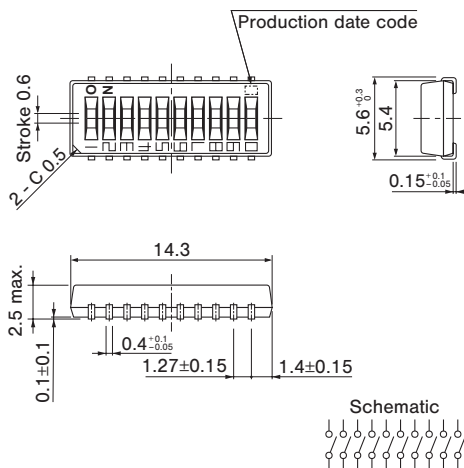

CHS-10B1 (In accordance with EIAJ ED-7402-1) Non-washable type (Without seal tape)

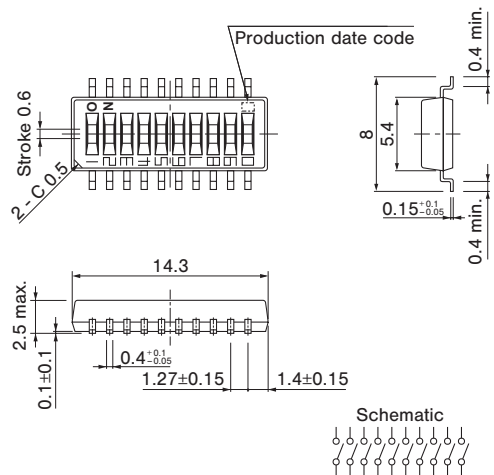

CHS

SLIDE SWITCHES (HALF PITCH)

OUTLINE DIMENSIONS

Unless otherwise specified, tolerance : ± 0.3 (Unit : mm)

- **CHS-01A**
Washable type (With seal tape)

- **CHS-01TA2**
Non-washable type (With seal tape)

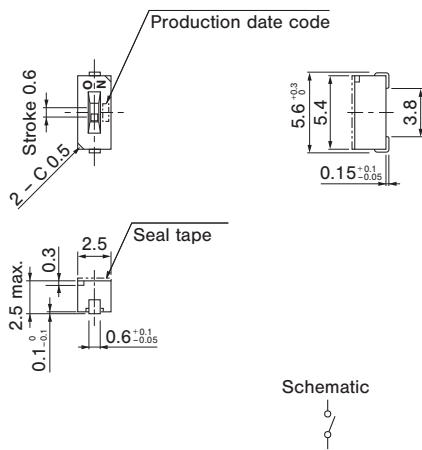

- **CHS-01B**
Washable type (With seal tape)

- **CHS-01TB2**
Non-washable type (With seal tape)

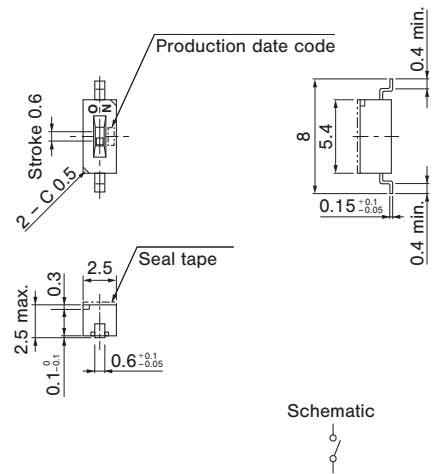

- **CHS-02A**
Washable type (With seal tape)

- **CHS-02TA2**
Non-washable type (With seal tape)

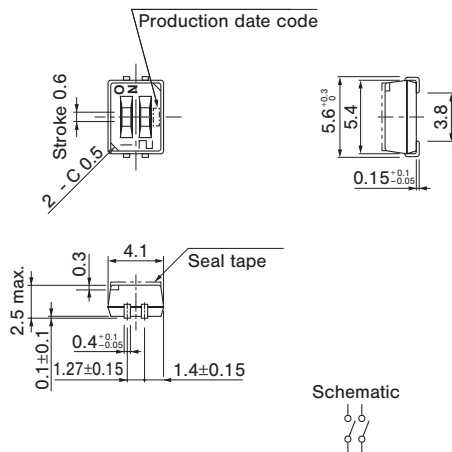

- **CHS-02B**
Washable type (With seal tape)

- **CHS-02TB2**
Non-washable type (With seal tape)

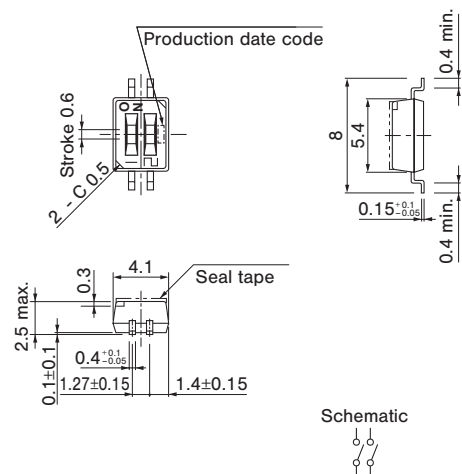

(In accordance with EIAJ ED-7402-1)

CHS

SLIDE SWITCHES (HALF PITCH)

OUTLINE DIMENSIONS

Unless otherwise specified, tolerance : ± 0.3 (Unit : mm)

- **CHS-04A**
Washable type (With seal tape)
- **CHS-04TA2**
Non-washable type (With seal tape)

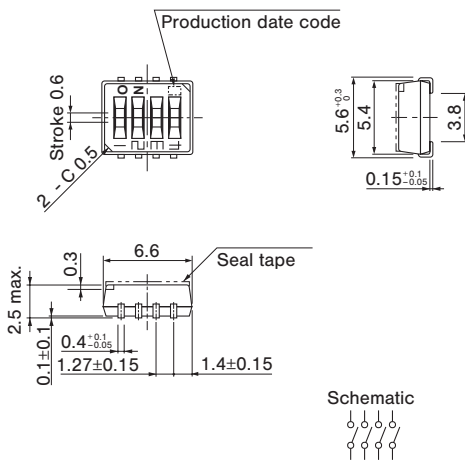

- **CHS-04B**
Washable type (With seal tape)
- **CHS-04TB2**
Non-washable type (With seal tape)

(In accordance with EIAJ ED-7402-1)

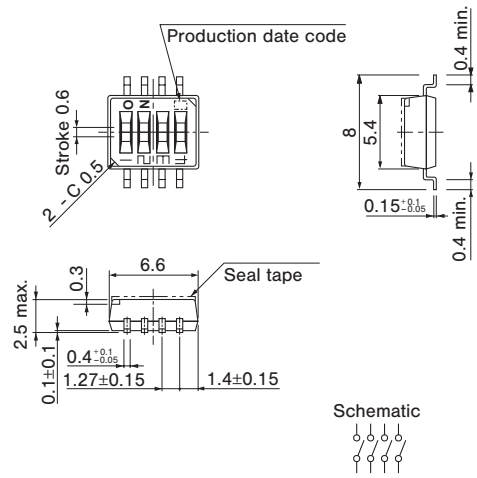

- **CHS-06A**
Washable type (With seal tape)
- **CHS-06TA2**
Non-washable type (With seal tape)

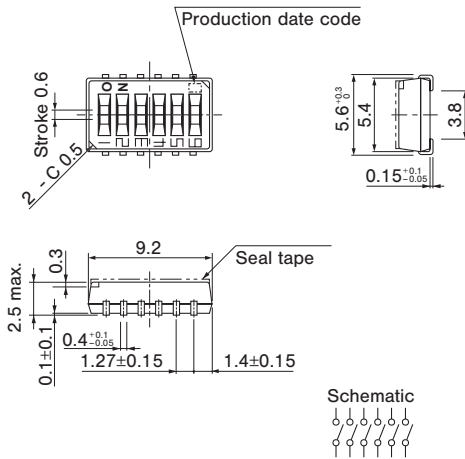

- **CHS-06B**
Washable type (With seal tape)
- **CHS-06TB2**
Non-washable type (With seal tape)

(In accordance with EIAJ ED-7402-1)

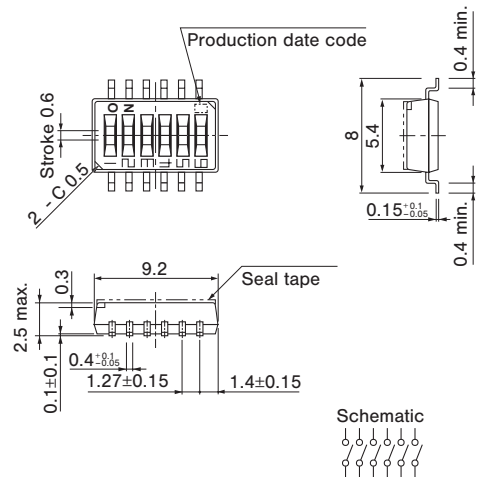

CHS SLIDE SWITCHES (HALF PITCH)

OUTLINE DIMENSIONS

Unless otherwise specified, tolerance : ± 0.3 (Unit : mm)

- **CHS-08A**
Washable type (With seal tape)

- **CHS-08TA2**
Non-washable type (With seal tape)

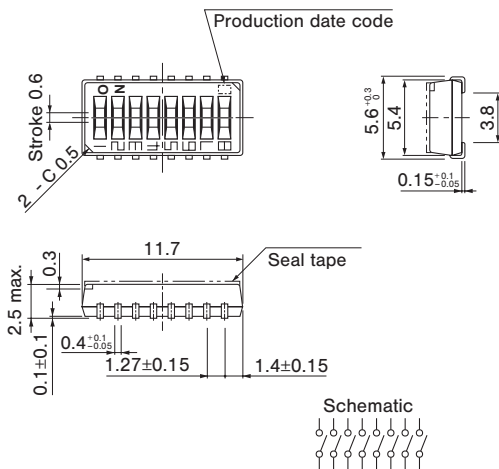

- **CHS-08B**
Washable type (With seal tape)

- **CHS-08TB2**
Non-washable type (With seal tape)

(In accordance with EIAJ ED-7402-1)

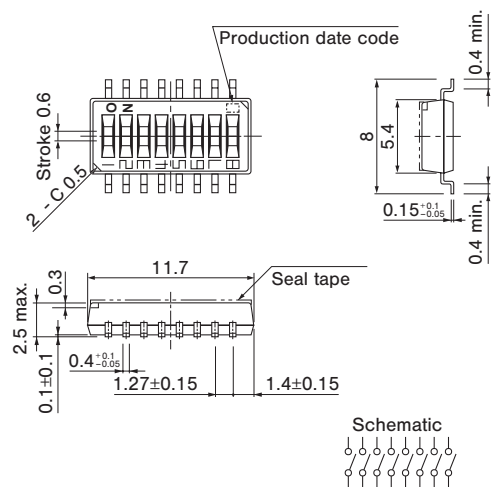

- **CHS-10A**
Washable type (With seal tape)

- **CHS-10TA2**
Non-washable type (With seal tape)

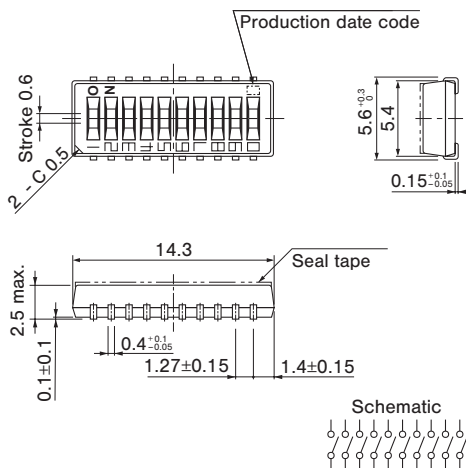

- **CHS-10B**
Washable type (With seal tape)

- **CHS-10TB2**
Non-washable type (With seal tape)

(In accordance with EIAJ ED-7402-1)

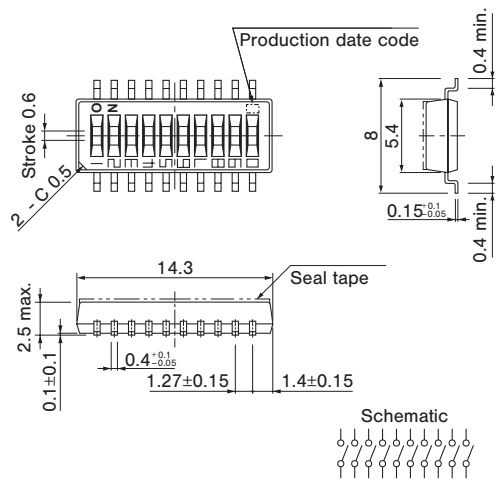

CHS

SLIDE SWITCHES (HALF PITCH)

OUTLINE DIMENSIONS

Unless otherwise specified, tolerance : ± 0.3 (Unit : mm)

< Reference > The D version with opposite pin direction is available upon receipt of your order.

CHS-08D

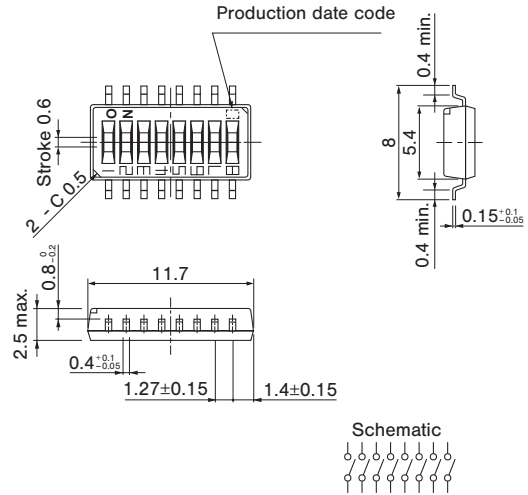
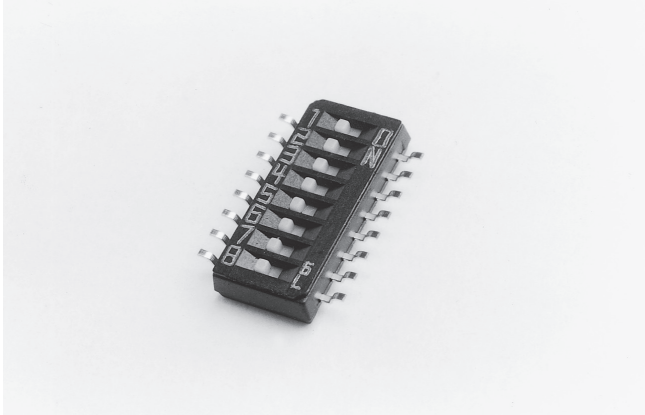

RECOMMENDED P.C.B. PAD OUTLINE DIMENSIONS

1 bit

(Unit : mm)

A type

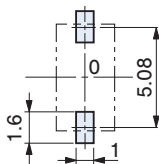

B type

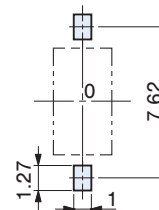

2 bits

A type

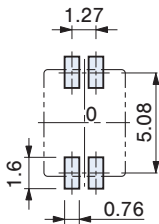

B type

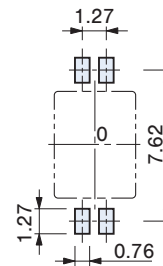

Note) The zero point is the center of mounting.

RECOMMENDED P.C.B. PAD OUTLINE DIMENSIONS

(Unit : mm)

4 bits

A type

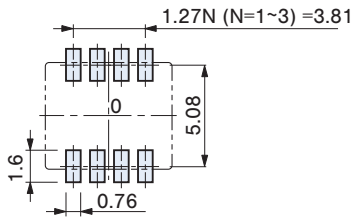

B type

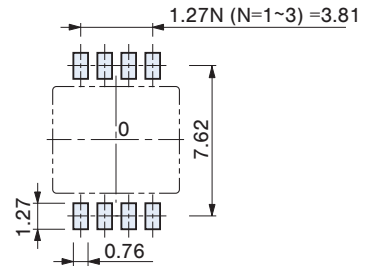

6 bits

A type

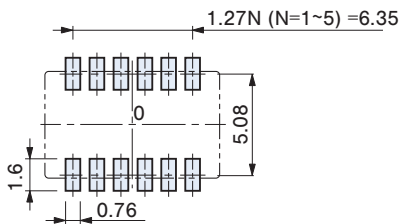

B type

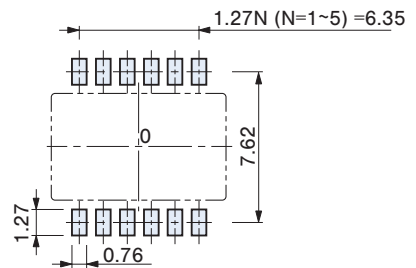

8 bits

A type

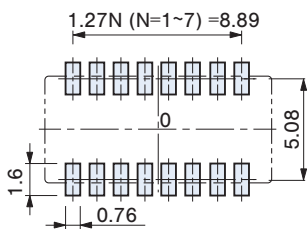

B type

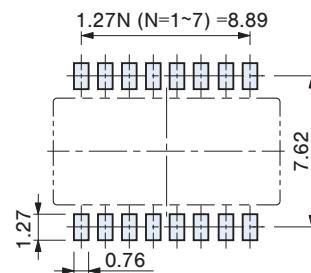

10 bits

A type

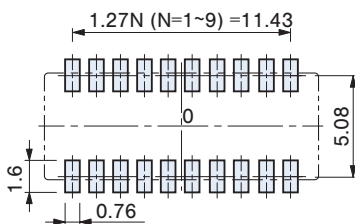

B type

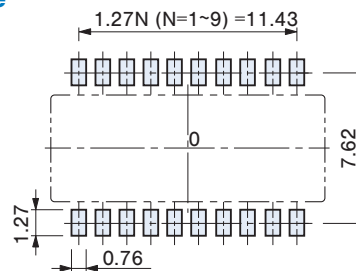

Note) The zero point is the center of mounting.

CHS

SLIDE SWITCHES (HALF PITCH)

PACKAGING SPECIFICATIONS

<Taping packaging specifications>

- Taping version (CHS-02 ~ 10 types) are packaged in 500 pcs. per reel. Orders will be accepted for units of 500 pcs., i.e., 500, 1000, 1500 pcs., etc.
CHS-01 type is packaged in 1000 pcs. per reel. Orders will be accepted for units of 1000 pcs., i.e., 2000, 3000 pcs., etc.
- Taping version is boxed with two reels.

Maximum number of consecutive missing pieces=2
Leader length and reel dimension are shown in the diagrams below:

● Embossed tape dimensions

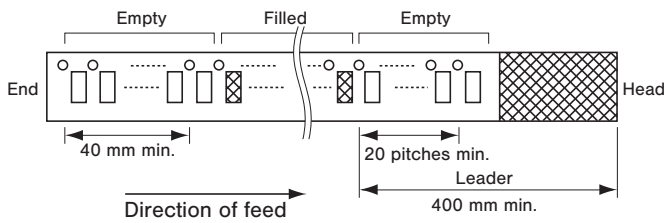

● Reel dimensions

(Conforms to JIS C 0806-3)
(In accordance with EIAJ ET-7200A)

(Unit: mm)

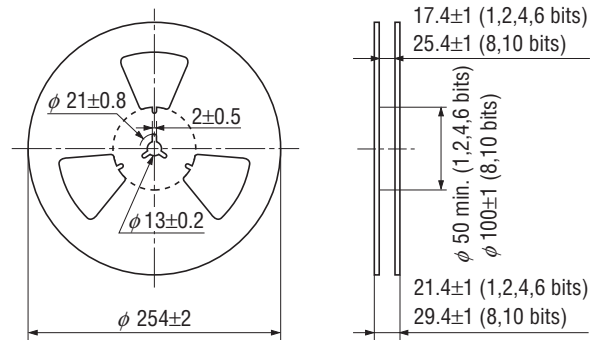

● 1 bit

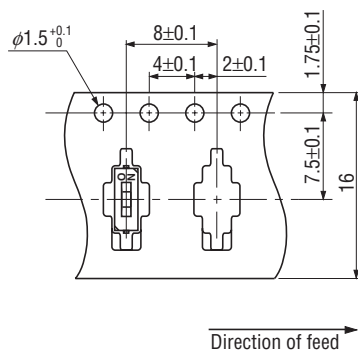

(Conforms to JIS C 0806)

(Unit : mm)

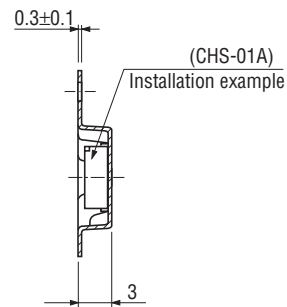

● 2 bits

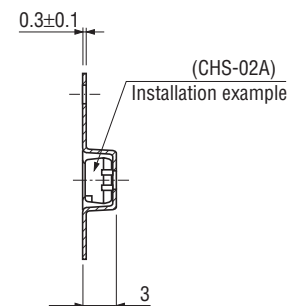
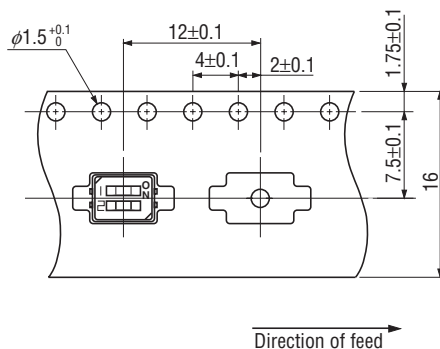

CHS SLIDE SWITCHES (HALF PITCH)

● 4 bits

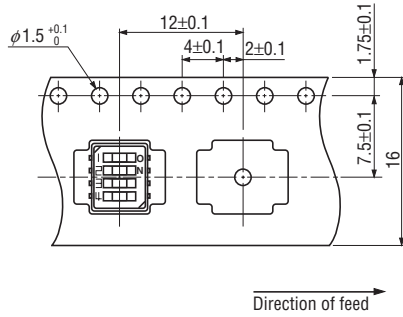

(Conforms to JIS C 0806)

(Unit : mm)

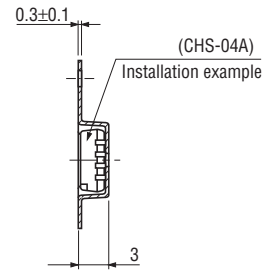

● 6 bits

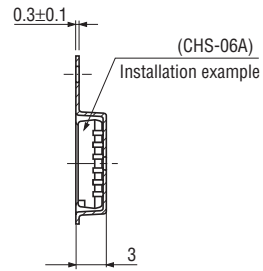
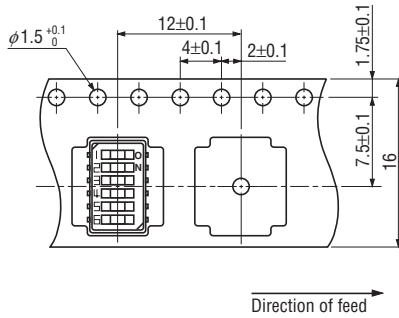

● 8 bits

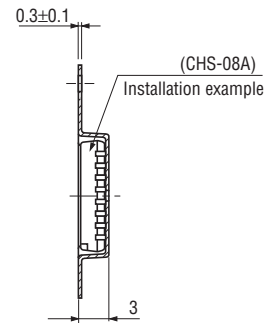
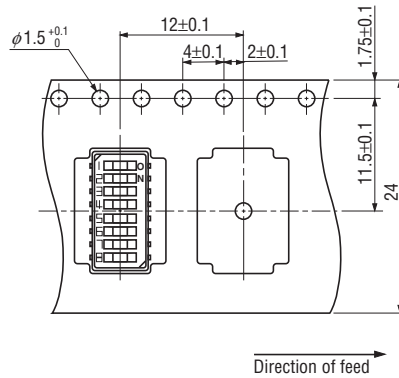

● 10 bits

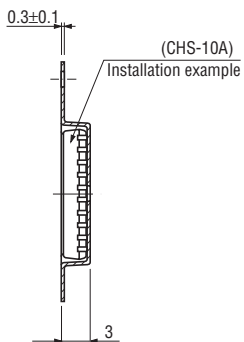
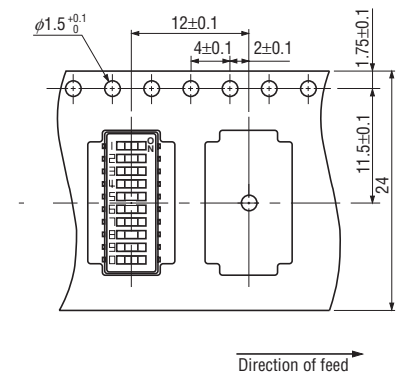

CHS

SLIDE SWITCHES (HALF PITCH)

<Magazine packaging specifications>

- Packing quantities of magazines are different depending on the bit number of the switches.
Please order the multiple numbers of the specific packing quantities. (e.g. 70 pcs., 140 pcs., 210 pcs., etc., in case of 4 bits version)

Pieces in package : 4 bits, 70pcs./stick
6 bits, 50pcs./stick
8 bits, 40pcs./stick
10 bits, 30pcs./stick

● Magazine dimensions

(Unit : mm)

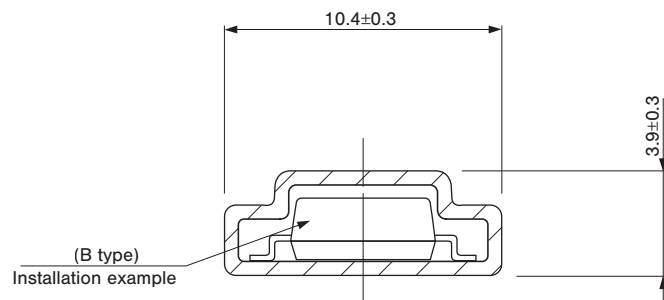



※ The magazine is common to A and B terminal pin.
Magazine length : 500 ± 2 mm long

<Bulk pack specifications>

- The smallest unit of bulk pack in a plastic bag is 10 pcs. per pack.
Orders will be accepted for unit of minimum 10 pcs., i.e., 10, 20, 30 pcs., etc.
- Boxing of bulk in a plastic bag is performed with 50 pcs. (standard 200 pcs.) per box.

Looking for pricing, stock, or lifecycle information?

Click below to explore more details on WIN SOURCE:

-  [View CHS-04TA on WIN SOURCE](#)
-  [Copal Electronics Inc. Information](#)

Optimize Your Supply Chain with WIN SOURCE Solutions

-  Global Sourcing Solution
-  Obsolete Management
-  Cost Control Management
-  Shortage Management
-  Alternative Solution
-  Excess Inventory Management