



**THE DATASHEET OF
SG2823L**



High Voltage Medium Current Driver Arrays

Description

The SG2800 series integrates eight NPN Darlington pairs with internal suppression diodes to drive lamps, relays, and solenoids in many military, aerospace, and industrial applications that require severe environments.

All units feature open collector outputs with greater than 50V breakdown voltages combined with 500mA current carrying capabilities.

Five different input configurations provide optimized designs for interfacing with DTL, TTL, PMOS, or CMOS drive signals.

These Darlington array are designed to operate from -55°C to 125°C ambient temperature in a 18-pin dual in-line ceramic (J) package and 20-pin leadless chip carrier (LCC).

In addition a plastic version is available in 18 lead SOWB (DW) package with a reduced temperature range of 0°C to 70°C.

Features

- Eight NPN Darlington Pairs
- Collector Currents to 600mA
- Output Voltages from 50V to 95V
- Internal Clamping Diodes for Inductive loads
- DTL, TTL, PMOS, or CMOS Compatible inputs

High Reliability Features

- Available To MIL-STD-883 – 883, ¶ 1.2.1
- Available to DSCC
 - Standard Microcircuit Drawing (SMD)
- MIL-M38510/14106BVA - SG2801J-JAN
- MIL-M38510/14107BVA - SG2802J-JAN
- MIL-M38510/14108BVA - SG2803J-JAN
- MIL-M38510/14109BVA - SG2804J-JAN
- MSC-AMS Level "S" Processing Available

Schematics (each Darlington pair)

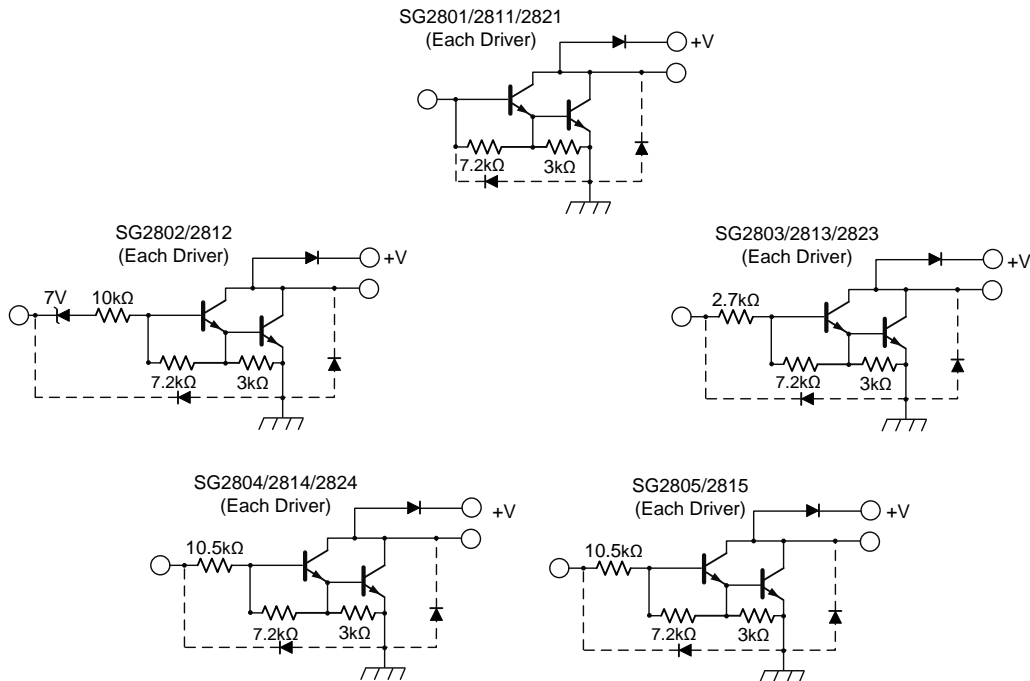

Figure 1 - Schematics (showing each Darlington pair)

Connection Diagrams and Ordering Information

Ambient Temperature	Type	Package	Part Number	Packaging Type	Connection Diagram
-55°C to 125°C	J	18-Pin Ceramic DIP Package	SG28XXJ-883B	CERDIP	
			SG2801J-JAN		
			SG2802J-JAN		
			SG2803J-JAN		
			SG2804J-JAN		
			SG2803J-DESC		
			SG2821J-DESC		
			SG2823J-DESC		
			SG2824J-DESC		
			SG28XXJ		
0°C to 70°C	DW	18-Pin Plastic SOIC Package	SG2803DW	SOWB	<p>DW Package: RoHS Compliant / Pb-free Transition DC: 0516</p> <p>Pinout same as J package</p> <p>DW Package: RoHS / Pb-free 100% Matte Tin Lead Finish</p>
-55°C to 125°C	L	20-Pin Ceramic Leadless Chip Carrier	SG28XXL-883B	CLCC	
			SG2803L-DESC		
			SG2821L-DESC		
			SG2823L-DESC		
			SG2824L-DESC		
			SG28XXL		
<p>Note:</p> <ol style="list-style-type: none"> Contact factory for JAN and DESC product availability. All parts are viewed from the top. See Selection Guide for specific device types. Hermetic Packages J, L use Pb37/Sn63 hot solder lead finish, contact factory for availability of RoHS versions. 					

Absolute Maximum Ratings¹

Parameter	Value	Units
Output Voltage, V_{CE} (SG2800, 2810 series)	50	V
(SG2820 series)	95	V
Input Voltage, V_{IN} (SG2802,3,4 series)	30	V
Continuous Input Current, I_{IN}	25	mA
Continuous Collector Current, I_C (SG2800, 2820)	500	mA
(SG2810)	600	mA
Operating Junction Temperature		
Plastic (DW Package)	150	°C
Hermetic (J, L Packages)	150	°C
Storage Temperature Range	-65 to 150	°C
Lead Temperature (Soldering 10 sec.)	300	°C
RoHS Peak Package Solder Reflow Temperature (40 sec. max. exp.)	260 (+0, -5)	°C
Note: 1. Exceeding these ratings could cause damage to the device. All voltages are with respect to ground. Currents are positive into, negative out of specified terminal.		

Thermal Data

Parameter	Value	Units
J Package		
Thermal Resistance-Junction to Case, θ_{JC}	25	°CW
Thermal Resistance-Junction to Ambient, θ_{JA}	70	°CW
L Package		
Thermal Resistance-Junction to Case, θ_{JC}	35	°CW
Thermal Resistance-Junction to Ambient, θ_{JA}	120	°CW
DW Package		
Thermal Resistance-Junction to Ambient, θ_{JA}	90	°CW
Note: <ol style="list-style-type: none"> Junction Temperature Calculation: $T_J = T_A + (P_D \times \theta_{JA})$. The above numbers for θ_{JC} are maximums for the limiting thermal resistance of the package in a standard mounting configuration. The θ_{JA} numbers are meant to be guidelines for the thermal performance of the device/pcboard system. All of the above assume no ambient airflow. 		

Recommended Operating Conditions¹

Symbol	Parameter	Recommended Operating Conditions			Units
		Min.	Typ.	Max.	
V _{CE}	Output Voltage				
	SG2800, SG2820 series			50	V
	SG2810 series			95	V
I _C	Peak Collector Current, I _C				
	SG2800, SG2820 series			350	mA
	SG2810 series			500	mA
Operating Ambient Temperature Range:					
	J, L Packages	-55		125	°C
	DW Packages	0		70	°C

Note: 1. Range over which the device is functional.

Selection Guide

Device	V _{CE} Max	I _C Max	Logic Inputs
SG2801	50V	500mA	General Purpose PMOS, CMOS
SG2802			14V-25V PMOS
SG2803			5V TTL, CMOS
SG2804			6V-15V CMOS, PMOS
SG2811			General Purpose PMOS, CMOS
SG2812	600mA	600mA	14V-25V PMOS
SG2813			5V TTL, CMOS
SG2814			6V-15V CMOS, PMOS
SG2815			High Output TTL
SG2821			95V
SG2823	5V TTL, CMOS		
SG2824	6V-15V CMOS, PMOS		

Electrical Characteristics

(Unless otherwise specified, these specifications apply over the operating ambient temperatures of $-55^{\circ}\text{C} \leq T_A \leq 125^{\circ}\text{C}$, for the J & L devices and $0^{\circ}\text{C} \leq T_A \leq 70^{\circ}\text{C}$, for the DW device. Low duty cycle pulse testing techniques are used which maintains junction and case temperatures equal to the ambient temperature.)

Table 1 - SG2801 thru SG2804

Symbol	Parameter	Applicable Devices	Temp.	Test Conditions	Limits			Units	
					Min	Type	Max		
I _{CEX}	Output Leakage Current (Figure 2a)	All		V _{CE} = 50V			100	μA	
	Output Leakage Current (Figure 2b)	SG2802		V _{CE} = 50V, V _{IN} = 6V			500	μA	
		SG2804		V _{CE} = 50V, V _{IN} = 1V			500	μA	
V _{CE(SAT)}	Collector – Emitter (V _{CE(SAT)}) (Figure 3)	All	T _A = T _{MIN}	I _C = 350mA, I _B = 850μA		1.6	1.8	V	
			T _A = T _{MIN}	I _C = 200mA, I _B = 550μA		1.3	1.5	V	
			T _A = T _{MIN}	I _C = 100mA, I _B = 350μA		1.1	1.3	V	
			T _A = 25°C	I _C = 350mA, I _B = 500μA		1.25	1.6	V	
			T _A = 25°C	I _C = 200mA, I _B = 350μA		1.1	1.3	V	
			T _A = 25°C	I _C = 100mA, I _B = 250μA		0.9	1.1	V	
			T _A = T _{MAX}	I _C = 350mA, I _B = 500μA		1.6	1.8	V	
			T _A = T _{MAX}	I _C = 200mA, I _B = 350μA		1.3	1.5	V	
I _{IN(ON)}	Input Current (Figure 4)	SG2802		V _{IN} = 17V	480	850	1300	μA	
		SG2803		V _{IN} = 3.85V	650	930	1350	μA	
		SG2804		V _{IN} = 5V	240	350	500	μA	
				V _{IN} = 12V	650	1000	1450	μA	
I _{IN(OFF)}	Input Current (Figure 5)	All	T _A = T _{MAX}	I _C = 500μA	25	50		μA	
V _{IN(ON)}	Input Voltage (Figure 6)	SG2802	T _A = T _{MIN}	V _{CE} = 2V, I _C = 300mA			18	V	
			T _A = T _{MAX}	V _{CE} = 2V, I _C = 300mA			13	V	
		SG2803	T _A = T _{MIN}	V _{CE} = 2V, I _C = 200mA				3.3	V
			T _A = T _{MIN}	V _{CE} = 2V, I _C = 250mA				3.6	V
			T _A = T _{MIN}	V _{CE} = 2V, I _C = 300mA				3.9	V
			T _A = T _{MAX}	V _{CE} = 2V, I _C = 200mA				2.4	V
			T _A = T _{MAX}	V _{CE} = 2V, I _C = 250mA				2.7	V
			T _A = T _{MAX}	V _{CE} = 2V, I _C = 300mA				3.0	V
		SG2804	T _A = T _{MIN}	V _{CE} = 2V, I _C = 125mA				6.0	V
			T _A = T _{MIN}	V _{CE} = 2V, I _C = 200mA				8.0	V
			T _A = T _{MIN}	V _{CE} = 2V, I _C = 275mA				10	V
			T _A = T _{MIN}	V _{CE} = 2V, I _C = 350mA				12	V
			T _A = T _{MAX}	V _{CE} = 2V, I _C = 125mA				5.0	V
			T _A = T _{MAX}	V _{CE} = 2V, I _C = 200mA				6.0	V
T _A = T _{MAX}	V _{CE} = 2V, I _C = 275mA					7.0	V		
T _A = T _{MAX}	V _{CE} = 2V, I _C = 350mA					8.0	V		

Symbol	Parameter	Applicable Devices	Temp.	Test Conditions	Limits			Units	
					Min	Type	Max		
h _{FE}	D-C Forward Current Transfer Ratio (Figure 3)	SG2801	T _A = T _{MIN}	V _{CE} = 2V, I _C = 350mA	500				
			T _A = 25°C	V _{CE} = 2V, I _C = 350mA	1000				
C _{IN}	Input Capacitance ¹	All	T _A = 25°C			15	25	pF	
TPLH	Turn-On Delay		T _A = 25°C	0.5 E _{IN} to 0.5 E _{OUT}		250	1000	ns	
TPHL	Turn-Off Delay		T _A = 25°C	0.5 E _{IN} to 0.5 E _{OUT}		250	1000	ns	
I _R	Clamp Diode Leakage Current (Figure 7)			V _R = 50V				50	μA
V _F	Clamp Diode Forward Voltage (Figure 8)			I _F = 350mA		1.7	2.0		V

Note: ¹This parameter, although guaranteed, are not tested in production.

Table 2 - SG2811 thru SG2815

Symbol	Parameter	Applicable Devices	Temp.	Test Conditions	Limits			Units
					Min	Type	Max	
I _{CEx}	Output Leakage Current (Figure 2a)	All		V _{CE} = 50V			100	μA
	Output Leakage Current (Figure 2b)	SG2812		V _{CE} = 50V, V _{IN} = 6V			500	μA
		SG2814		V _{CE} = 50V, V _{IN} = 1V			500	μA
V _{CE(SAT)}	Collector – Emitter (V _{CE(SAT)}) (Figure 3)	All	T _A = T _{MIN}	I _C = 500mA, I _B = 1100μA		1.8	1.1	V
			T _A = T _{MIN}	I _C = 350mA, I _B = 850μA		1.6	1.8	V
			T _A = T _{MIN}	I _C = 200mA, I _B = 550μA		1.3	1.5	V
			T _A = 25°C	I _C = 500mA, I _B = 600μA		1.7	1.9	V
			T _A = 25°C	I _C = 350mA, I _B = 500μA		1.25	1.6	V
			T _A = 25°C	I _C = 200mA, I _B = 350μA		1.1	1.3	V
			T _A = T _{MAX}	I _C = 500mA, I _B = 600μA		1.8	2.1	V
			T _A = T _{MAX}	I _C = 350mA, I _B = 500μA		1.6	1.8	V
I _{IN(ON)}	Input Current (Figure 4)	SG2812		V _{IN} = 17V	480	850	1300	μA
		SG2813		V _{IN} = 3.85V	650	930	1350	μA
		SG2814		V _{IN} = 5V	240	350	500	μA
				V _{IN} = 12V	650	1000	1450	μA
		SG2815		V _{IN} = 3V	1180	1500	2400	μA
I _{IN(OFF)}	Input Current (Figure 5)	All	T _A = T _{MAX}	I _C = 500μA	25	50		μA
V _{IN(ON)}	Input Voltage (Figure 6)	SG2812	T _A = T _{MIN}	V _{CE} = 2V, I _C = 500mA			23.5	V
			T _A = T _{MAX}	V _{CE} = 2V, I _C = 500mA			17	V

Symbol	Parameter	Applicable Devices	Temp.	Test Conditions	Limits			Units	
					Min	Type	Max		
$V_{IN(ON)}$	Input Voltage (Figure 6)	SG2813	$T_A = T_{MIN}$	$V_{CE} = 2V, I_C = 250mA$			3.6	V	
			$T_A = T_{MIN}$	$V_{CE} = 2V, I_C = 300mA$			3.9	V	
			$T_A = T_{MIN}$	$V_{CE} = 2V, I_C = 500mA$			6.0	V	
			$T_A = T_{MAX}$	$V_{CE} = 2V, I_C = 250mA$			2.7	V	
			$T_A = T_{MAX}$	$V_{CE} = 2V, I_C = 300mA$			3.0	V	
			$T_A = T_{MAX}$	$V_{CE} = 2V, I_C = 500mA$			3.5	V	
		SG2814	$T_A = T_{MIN}$	$V_{CE} = 2V, I_C = 275mA$				10	V
			$T_A = T_{MIN}$	$V_{CE} = 2V, I_C = 350mA$				12	V
			$T_A = T_{MIN}$	$V_{CE} = 2V, I_C = 500mA$				17	V
			$T_A = T_{MAX}$	$V_{CE} = 2V, I_C = 275mA$				7.0	V
			$T_A = T_{MAX}$	$V_{CE} = 2V, I_C = 350mA$				8.0	V
			$T_A = T_{MAX}$	$V_{CE} = 2V, I_C = 500mA$				9.5	V
		SG2815	$T_A = T_{MIN}$	$V_{CE} = 2V, I_C = 350mA$				3.0	V
			$T_A = T_{MIN}$	$V_{CE} = 2V, I_C = 500mA$				3.5	V
			$T_A = T_{MAX}$	$V_{CE} = 2V, I_C = 350mA$				2.4	V
$T_A = T_{MAX}$	$V_{CE} = 2V, I_C = 500mA$					2.6	V		
h_{FE}	D-C Forward Current Transfer Ratio (Figure 3)	SG2811	$T_A = T_{MIN}$	$V_{CE} = 2V, I_C = 500mA$	450				
			$T_A = 25^\circ C$	$V_{CE} = 2V, I_C = 500mA$	900				
C_{IN}	Input Capacitance ¹	All	$T_A = 25^\circ C$			15	25	pF	
TPLH	Turn-On Delay		$T_A = 25^\circ C$	0.5 E_{IN} to 0.5 E_{OUT}		250	1000	ns	
TPHL	Turn-Off Delay		$T_A = 25^\circ C$	0.5 E_{IN} to 0.5 E_{OUT}		250	1000	ns	
I_R	Clamp Diode Leakage Current (Figure 7)			$V_R = 50V$				50	μA
V_F	Clamp Diode Forward Voltage (Figure 8)			$I_F = 350mA$		1.7	2.0	V	
				$I_F = 500mA$			2.5	V	
Note: ¹ This parameter, although guaranteed, are not tested in production.									

Table 3 - SG2821 thru SG2824

Symbol	Parameter	Applicable Devices	Temp.	Test Conditions	Limits			Units
					Min	Type	Max	
I_{CEX}	Output Leakage Current (Figure 2a)	All		$V_{CE} = 95V$			100	μA
	Output Leakage Current (Figure 2b)	SG2824		$V_{CE} = 95V, V_{IN} = 1V$			500	μA

Symbol	Parameter	Applicable Devices	Temp.	Test Conditions	Limits			Units	
					Min	Type	Max		
$V_{CE(SAT)}$	Collector – Emitter ($V_{CE(SAT)}$) (Figure 3)	All	$T_A = T_{MIN}$	$I_C = 350mA, I_B = 850\mu A$		1.6	1.8	V	
			$T_A = T_{MIN}$	$I_C = 200mA, I_B = 550\mu A$		1.3	1.5	V	
			$T_A = T_{MIN}$	$I_C = 100mA, I_B = 350\mu A$		1.1	1.3	V	
			$T_A = 25^\circ C$	$I_C = 350mA, I_B = 500\mu A$		1.25	1.6	V	
			$T_A = 25^\circ C$	$I_C = 200mA, I_B = 350\mu A$		1.1	1.3	V	
			$T_A = 25^\circ C$	$I_C = 100mA, I_B = 250\mu A$		0.9	1.1	V	
			$T_A = T_{MAX}$	$I_C = 350mA, I_B = 500\mu A$		1.6	1.8	V	
			$T_A = T_{MAX}$	$I_C = 200mA, I_B = 350\mu A$		1.3	1.5	V	
$I_{IN(ON)}$	Input Current (Figure 4)	SG2823		$V_{IN} = 3.85V$	650	930	1350	μA	
		SG2824		$V_{IN} = 5V$	240	350	500	μA	
				$V_{IN} = 12V$	650	1000	1450	μA	
$I_{IN(OFF)}$	Input Current (Figure 5)	All	$T_A = T_{MAX}$	$I_C = 500\mu A$	25	50		μA	
$V_{IN(ON)}$	Input Voltage (Figure 6)	SG2823	$T_A = T_{MIN}$	$V_{CE} = 2V, I_C = 200mA$			3.3	V	
			$T_A = T_{MIN}$	$V_{CE} = 2V, I_C = 250mA$			3.6	V	
			$T_A = T_{MIN}$	$V_{CE} = 2V, I_C = 300mA$			3.9	V	
			$T_A = T_{MAX}$	$V_{CE} = 2V, I_C = 200mA$			2.4	V	
			$T_A = T_{MAX}$	$V_{CE} = 2V, I_C = 250mA$			2.7	V	
			$T_A = T_{MAX}$	$V_{CE} = 2V, I_C = 300mA$			3.0	V	
		SG2824	$T_A = T_{MIN}$	$V_{CE} = 2V, I_C = 125mA$			6.0	V	
			$T_A = T_{MIN}$	$V_{CE} = 2V, I_C = 200mA$			8.0	V	
			$T_A = T_{MIN}$	$V_{CE} = 2V, I_C = 275mA$			10	V	
			$T_A = T_{MIN}$	$V_{CE} = 2V, I_C = 350mA$			12	V	
			$T_A = T_{MAX}$	$V_{CE} = 2V, I_C = 125mA$			5.0	V	
			$T_A = T_{MAX}$	$V_{CE} = 2V, I_C = 200mA$			6.0	V	
			$T_A = T_{MAX}$	$V_{CE} = 2V, I_C = 275mA$			7.0	V	
			$T_A = T_{MAX}$	$V_{CE} = 2V, I_C = 350mA$			8.0	V	
h_{FE}	D-C Forward Current Transfer Ratio (Figure 3)	SG2821	$T_A = T_{MIN}$	$V_{CE} = 2V, I_C = 350mA$	500				
			$T_A = 25^\circ C$	$V_{CE} = 2V, I_C = 350mA$	1000				
C_{IN}	Input Capacitance ¹	All	$T_A = 25^\circ C$			15	25	pF	
TPLH	Turn-On Delay					0.5 E_{IN} to 0.5 E_{OUT}	250	1000	ns
TPHL	Turn-Off Delay					0.5 E_{IN} to 0.5 E_{OUT}	250	1000	ns
I_R	Clamp Diode Leakage Current (Figure 7)	All		$V_R = 95V$			50	μA	
V_F	Clamp Diode Forward Voltage (Figure 8)				$I_F = 350mA$		1.7	2.0	V

Note: ¹This parameter, although guaranteed, are not tested in production.

Parameter Test Figures

(See figure numbers in Electrical Characteristics Tables 1 to 3)

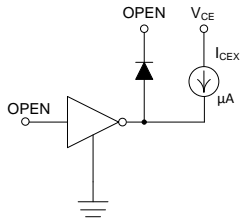

Figure 2a
 I_{CEX} Test Circuit

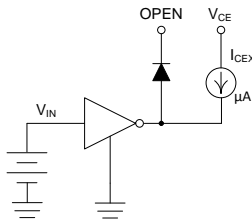

Figure 2b
 I_{CEX} Test Circuit

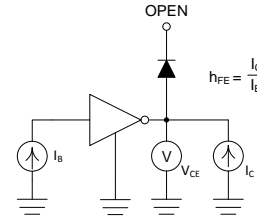

Figure 3
 h_{FE} , $V_{CE(sat)}$ Test Circuit

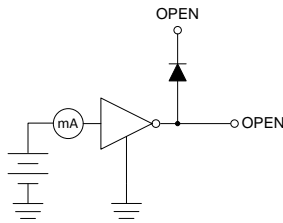

Figure 4
 $I_{IN(ON)}$ Test Circuit

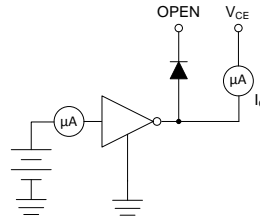

Figure 5
 $I_{IN(OFF)}$ Test Circuit

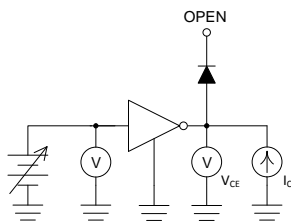

Figure 6
 $V_{IN(ON)}$ Test Circuit

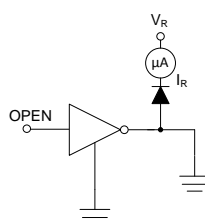

Figure 7
 I_R Test Circuit

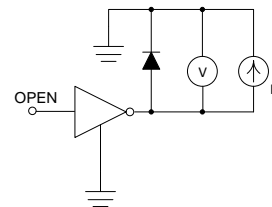

Figure 8
 V_F Test Circuit

Characteristic Curves

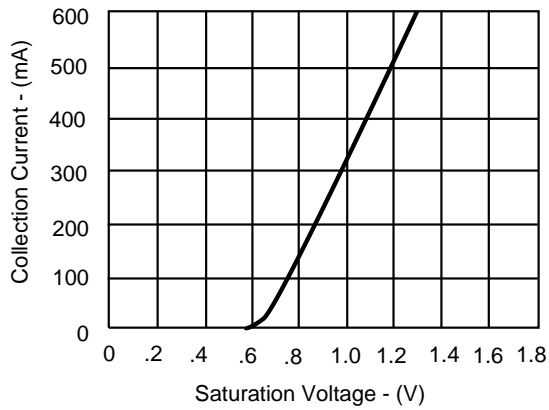

Figure 8 - Output Characteristics

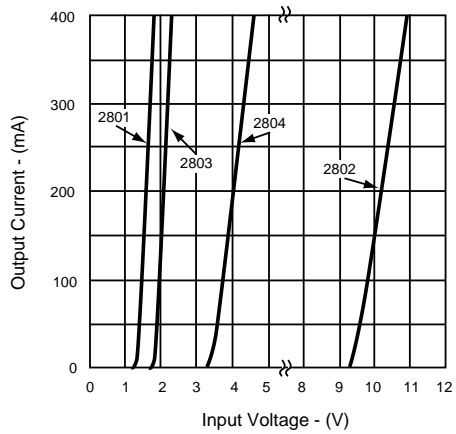

Figure 9 - Output Current Vs. Input Voltage

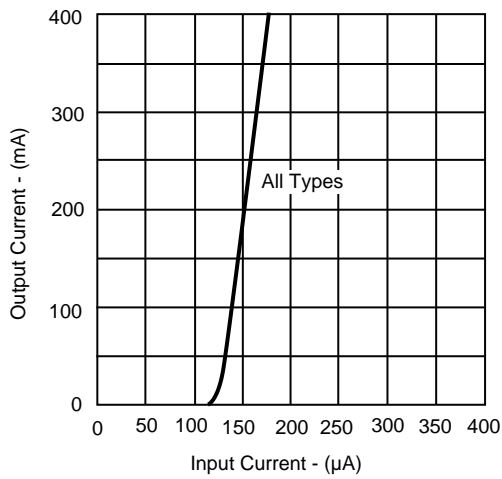

Figure 10 - Output Current Vs. Input Current

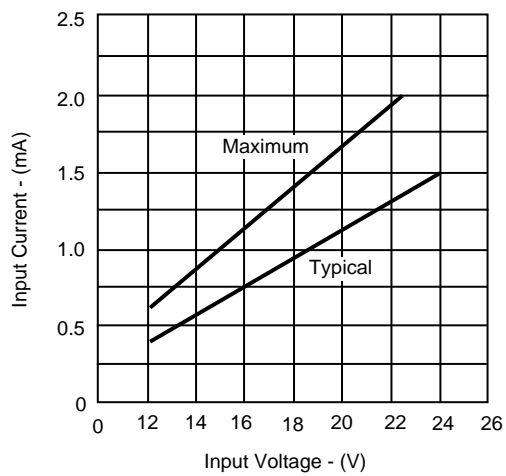

Figure 11 - Input Characteristics - SG2802

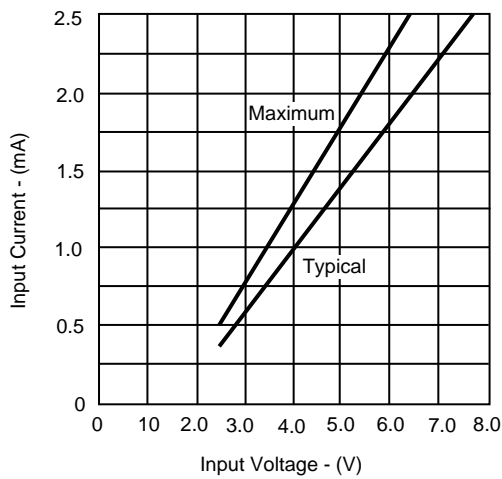

Figure 12 - Input Characteristics - SG2803

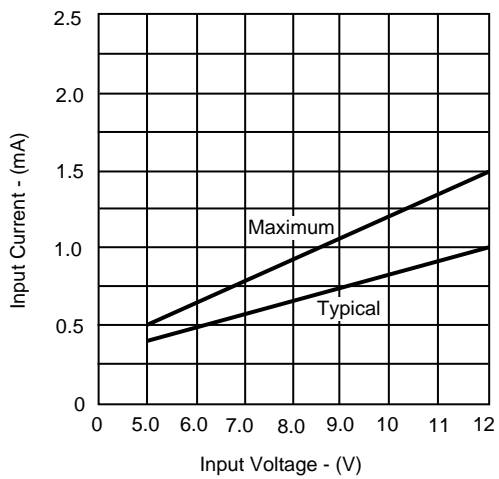

Figure 13 - Input Characteristics - SG2804

Characteristic Curves - Continued

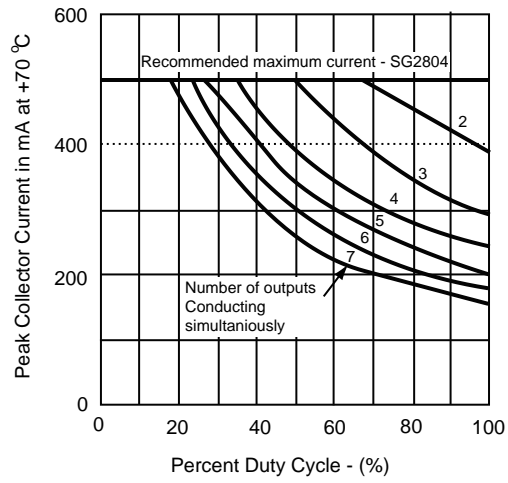
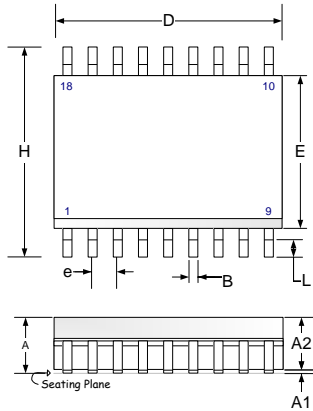

Figure 14 - Peak Collector Current Vs. Duty Cycle

Package Outline Dimensions

Controlling dimensions are in inches, metric equivalentents are shown for general information.



Dim	MILLIMETERS		INCHES	
	MIN	MAX	MIN	MAX
A	2.06	2.65	0.081	0.104
A1	0.10	0.30	0.004	0.012
A2	2.03	2.55	0.080	0.100
B	0.25	0.51	0.010	0.020
c	0.23	0.32	0.009	0.013
D	-	13.21	-	0.520
E	7.40	7.75	0.291	0.305
e	1.27 BSC		0.50 BSC	
H	10.00	10.65	0.394	0.419
L	0.4	1.27	0.016	0.050
Θ	0	8	0	8
*LC	-	0.10	-	0.004

*Lead coplanarity

Note:

Dimensions do not include protrusions; these shall not exceed 0.155mm (.006") on any side. Lead dimension shall not include solder coverage.

Figure 15 - DW Package Dimensions

Package Outline Dimensions

Controlling dimensions are in inches, metric equivalents are shown for general information.

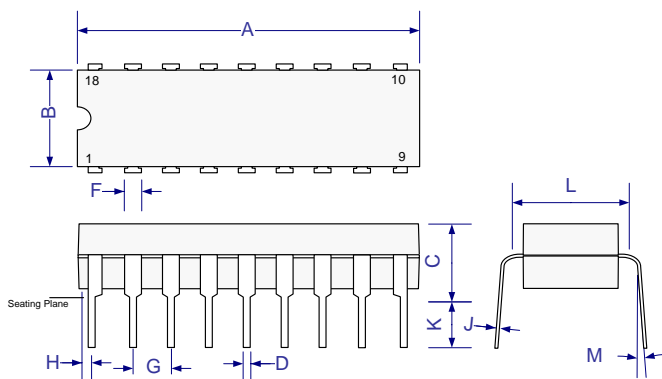

Dim	MILLIMETERS		INCHES	
	MIN	MAX	MIN	MAX
A	-	24.38	-	0.960
B	5.59	7.11	0.220	0.280
C	-	5.08	-	0.200
D	0.38	0.51	0.015	0.020
F	1.02	1.77	0.040	0.070
G	2.54 BSC		0.100 BSC	
H	-	2.03	-	0.080
J	0.20	0.38	0.008	0.015
K	3.18	5.08	0.125	0.200
L	7.37	7.87	0.290	0.310
M	-	15°	-	15°

Note:

Dimensions do not include protrusions; these shall not exceed 0.155mm (.006") on any side. Lead dimension shall not include solder coverage.

Figure 16 - J 18-Pin Ceramic Dual In Line Package Dimensions

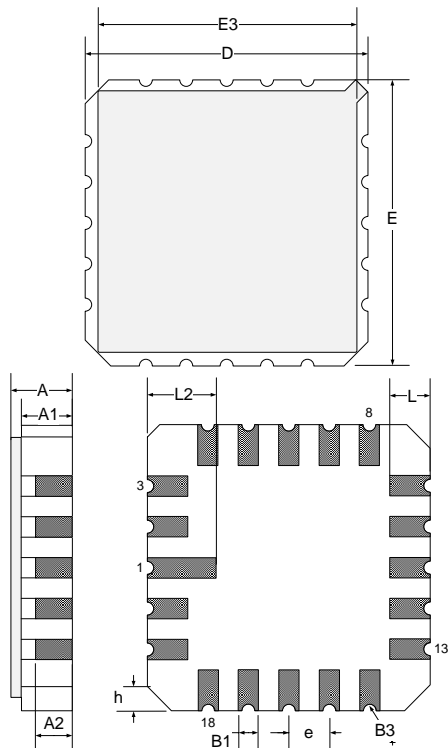

Dim	MILLIMETERS		INCHES	
	MIN	MAX	MIN	MAX
D/E	8.64	9.14	0.340	0.360
E3	-	8.128	-	0.320
e	1.270 BSC		0.050 BSC	
B1	0.635 TYP		0.025 TYP	
L	1.02	1.52	0.040	0.060
A	1.626	2.286	0.064	0.090
h	1.016 TYP		0.040 TYP	
A1	1.372	1.68	0.054	0.066
A2	-	1.168	-	0.046
L2	1.91	2.41	0.075	0.95
B3	0.203R		0.008R	

Note:

1. All exposed metalized area shall be gold plated 60 micro-inch minimum thickness over nickel plated unless otherwise specified in purchase order.

Figure 17 - L 20-Pin Ceramic Leadless Chip Carrier (LCC) Package Outline Dimensions



Microsemi Corporate Headquarters
One Enterprise, Aliso Viejo,
CA 92656 USA

Within the USA: +1 (800) 713-4113
Outside the USA: +1 (949) 380-6100
Sales: +1 (949) 380-6136
Fax: +1 (949) 215-4996

E-mail: sales.support@microsemi.com



© 2014 Microsemi Corporation. All rights reserved. Microsemi and the Microsemi logo are trademarks of Microsemi Corporation. All other trademarks and service marks are the property of their respective owners.

Microsemi Corporation (Nasdaq: MSCC) offers a comprehensive portfolio of semiconductor and system solutions for communications, defense & security, aerospace and industrial markets. Products include high-performance and radiation-hardened analog mixed-signal integrated circuits, FPGAs, SoCs and ASICs; power management products; timing and synchronization devices and precise time solutions, setting the world's standard for time; voice processing devices; RF solutions; discrete components; security technologies and scalable anti-tamper products; Power-over-Ethernet ICs and midspans; as well as custom design capabilities and services. Microsemi is headquartered in Aliso Viejo, Calif., and has approximately 3,400 employees globally. Learn more at www.microsemi.com.

Microsemi makes no warranty, representation, or guarantee regarding the information contained herein or the suitability of its products and services for any particular purpose, nor does Microsemi assume any liability whatsoever arising out of the application or use of any product or circuit. The products sold hereunder and any other products sold by Microsemi have been subject to limited testing and should not be used in conjunction with mission-critical equipment or applications. Any performance specifications are believed to be reliable but are not verified, and Buyer must conduct and complete all performance and other testing of the products, alone and together with, or installed in, any end-products. Buyer shall not rely on any data and performance specifications or parameters provided by Microsemi. It is the Buyer's responsibility to independently determine suitability of any products and to test and verify the same. The information provided by Microsemi hereunder is provided "as is, where is" and with all faults, and the entire risk associated with such information is entirely with the Buyer. Microsemi does not grant, explicitly or implicitly, to any party any patent rights, licenses, or any other IP rights, whether with regard to such information itself or anything described by such information. Information provided in this document is proprietary to Microsemi, and Microsemi reserves the right to make any changes to the information in this

Looking for pricing, stock, or lifecycle information?

Click below to explore more details on WIN SOURCE:

-  [View SG2823L on WIN SOURCE](#)
-  [Microchip Technology](#) Information

Optimize Your Supply Chain with WIN SOURCE Solutions

-  Global Sourcing Solution
-  Obsolete Management
-  Cost Control Management
-  Shortage Management
-  Alternative Solution
-  Excess Inventory Management