



**THE DATASHEET OF
CGS74LCT2524M**



CGS74LCT2524

CGS74LCT2524 1 to 4 Minimum Skew (300 ps) 3V Clock Driver



Literature Number: SNOS710C

1 to 4 Minimum Skew (300 ps) 3V Clock Driver

General Description

This minimum skew clock driver is a 3V option of the current CGS74CT2524 Minimum Skew Clock Driver and is designed for Clock Generation and Support (CGS) applications operating at low voltage, high frequencies. This device guarantees minimum output skew across the outputs of a given device.

Skew parameters are also provided as a means to measure duty cycle requirements as those found in high speed clocking systems. This minimum skew clock driver with one input driving four outputs, is specifically designed for signal generation and clock distribution applications.

Features

- Ideal for low power/low noise high speed applications
- Guaranteed:
 - 300 ps pin-to-pin skew (t_{OSHL} and t_{OSLH})
- Implemented on National's FACT™ family process
- 1 input to 4 outputs low skew clock distribution
- Symmetric output current drive: 12 mA I_{OH}/I_{OL}
- Industrial temperature of -40°C to $+85^{\circ}\text{C}$
- 8-pin SOIC package
- Low dynamic power consumption above 20 MHz
- Guaranteed 2 kV ESD protection

Logic Symbol

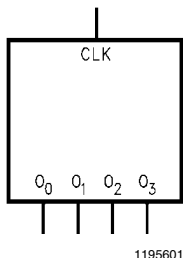

The output pins act as a single entity and will follow the state of the CLK when the clock distribution chip is selected.

Pin Description

Pin Names	Description
CLK	Clock Input
O_0-O_3	Outputs

Truth Table

Inputs	Outputs
CLK	O_0-O_3
L	L
H	H

L = Low Logic Level
H = High Logic Level

Connection Diagrams

Pin Assignment
SOIC (MO)

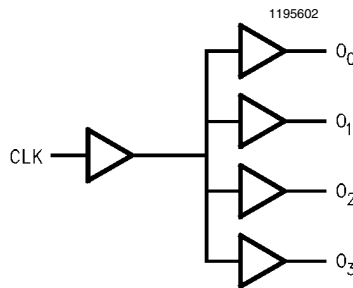
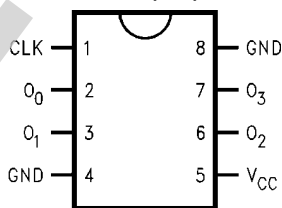

See NS Package Number M08A

Absolute Maximum Ratings *(Note 1)*

If Military/Aerospace specified devices are required, please contact the National Semiconductor Sales Office/Distributors for availability and specifications.

Supply Voltage (V_{CC})	-0.5V to 7.0V
DC Input Voltage Diode Current (I_{IK})	
$V = -0.5V$	-20 mA
$V = V_{CC} + 0.5V$	+20 mA
DC Input Voltage (V_I)	-0.5V to $V_{CC} + 0.5V$
DC Output Diode Current (I_O)	
$V = -0.5V$	-20 mA
$V = V_{CC} + 0.5V$	+20 mA
DC Output Voltage (V_O)	-0.5V to $V_{CC} + 0.5V$
DC Output Source or Sink Current (I_O)	±50 mA
DC V_{CC} or Ground Current per Output Pin (I_{CC} or I_{GND})	±50 mA

Storage Temperature (T_{STG}) -65°C to +150°C

Junction Temperature (θ_{JA})

Airflow 0 225 500 LFM
M 167 132 117 °C/W

Recommended Operating Conditions

Supply Voltage (V_{CC})	3.0V to 3.6V
Input Voltage (V_{IN})	0V to V_{CC}
Output Voltage (V_O)	0V to V_{CC}
Operating Temperature (T_A)	
Industrial	-40°C to +85°C
Commercial	0°C to +70°C
Input Rise and Fall Times (0.8V to 2.0V)	9.6 ns max

Note 1: The Absolute Maximum Ratings are those values beyond which the safety of the device cannot be guaranteed. The device should not be operated at these limits. The parametric values defined in the DC and AC Electrical Characteristics tables are not guaranteed at the absolute maximum ratings. The Recommended Operating Conditions will define the conditions for actual device operation.

DC Electrical Characteristics

Over recommended operating conditions unless specified otherwise.

Symbol	Parameter	Conditions	V_{CC} (V)	CGS74LCT2524			Units
				$T_A = +25^\circ\text{C}$		$T_A = -40^\circ\text{C to } +85^\circ\text{C}$	
				Typ	Guaranteed Limits		
V_{IH}	Minimum High Level Input Voltage	$V_{OUT} = 0.1V$ or $V_{CC} - 0.1V$	3.6	1.5	2.0	2.0	V
V_{IL}	Maximum Low Level Input Voltage	$V_{OUT} = 0.1V$ or $V_{CC} - 0.1V$	3.6	1.5	0.8	0.8	V
V_{OH}	Minimum High Level Output Voltage	$V_{IN} = V_{IL}$ or V_{IH} , $I_{OUT} = -50 \mu\text{A}$	3.0		2.9	2.9	V
		$V_{IN} = V_{IL}$ or V_{IH} , $I_{OH} = -12 \text{ mA}$	3.0		2.5	2.4	V
V_{OL}	Minimum Low Level Output Voltage	$V_{IN} = V_{IL}$ or V_{IH} , $I_{OUT} = 50 \mu\text{A}$	3.0		0.1	0.1	V
		$V_{IN} = V_{IL}$ or V_{IH} , $I_{OL} = -12 \text{ mA}$	3.0		0.3	0.4	V
I_{IN}	Maximum Input Leakage Current	$V_{IN} = V_{CC}, \text{GND}$	3.6		±0.1	±1.0	µA
I_{CCT}	Maximum I_{CC} /Input	$V_{IN} = 3.0V$	3.6			100	µA
I_{OLD}	Minimum Dynamic	$V_{OLD} = 0.8V$ (max)	3.6			36	mA
I_{OHD}	Output Current	$V_{OHD} = 2.0V$ (min)	3.6			-25	mA
I_{CC}	Maximum Quiescent Supply Current	$V_{IN} = V_{CC}$ or GND	3.6		2.5	10	µA

AC Electrical Characteristics

Over recommended operating conditions unless specified otherwise. All typical values are measured at $V_{CC} = 3.3V$, $T_A = 25^\circ C$

Symbol	Parameter	LCT2524			Units
		$V_{CC} = 3.0V$ to $3.6V$ $T_A = -40^\circ C$ to $+85^\circ C$ $C_L = 50$ pF $R_L = 500\Omega$			
		Min	Typ	Max	
t_{PLH}	Low-to-High Propagation Delay CLK to O_n	6		15.0	ns
t_{PHL}	High-to-Low Propagation Delay CLK to O_n	6		15.0	ns

Extended AC Electrical Characteristics

Over recommended operating conditions unless specified otherwise. All typical values are measured at $V_{CC} = 3.3V$, $T_A = 25^\circ C$

Symbol	Parameter	LCT2524			Units
		$V_{CC} = 3.0V$ to $3.6V$ $T_A = -40^\circ C$ to $+85^\circ C$ $C_L = 50$ pF $R_L = 500\Omega$			
		Min	Typ	Max	
f_{max}	Maximum Operating Frequency		75		MHz
t_{OSHL}	Maximum Skew Common Edge Output-to-Output Variation (<i>Note 2</i>)			300	ps
t_{OSLH}	Maximum Skew Common Edge Output-to-Output Variation (<i>Note 2</i>)			300	ps
t_{PS}	Maximum Skew Pin (Signal) Transition Variation (<i>Note 3</i>)			2.5	ns
t_{RISE} t_{FALL}	Rise Time/Fall Time (from 0.8V to 2.0V/2.0V to 0.8V)			2.5	ns
T_{HIGH}	Time High	4			ns
T_{LOW}	Time Low	4			ns

Note 2: Output-to-Output Skew is defined as the absolute value of the difference between the actual propagation delay for any outputs within the same packaged device. The specifications apply to any outputs switching in the same direction either HIGH-to-LOW (t_{OSHL}) or LOW-to-HIGH (t_{OSLH}) or in opposite directions both HL and LH (t_{OST}). Limits are characterized and guaranteed by design @ 66 MHz.

Note 3: Pin transition skew is the absolute difference between HIGH-to-LOW and LOW-to-HIGH propagation delay, measured at a given output pin.

Note 4: Refer to Minimum Skew Parameters Measurement Information Chart for definitions of each skew specification.

Note 5: Load capacitance includes the test jig.

Timing Diagrams

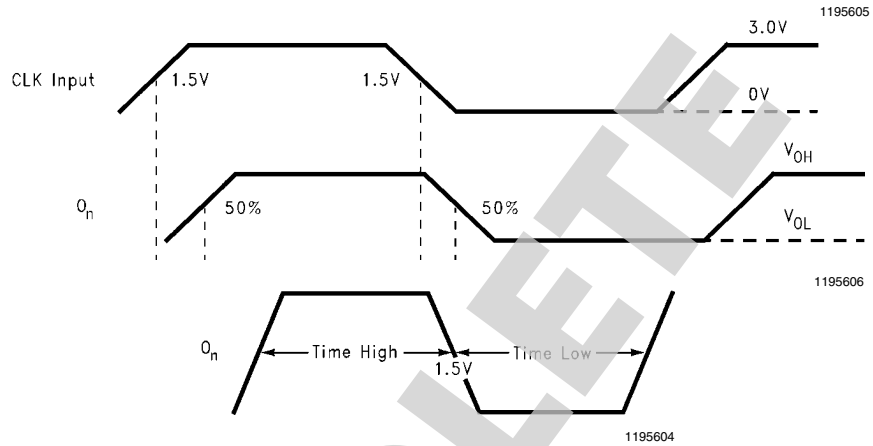
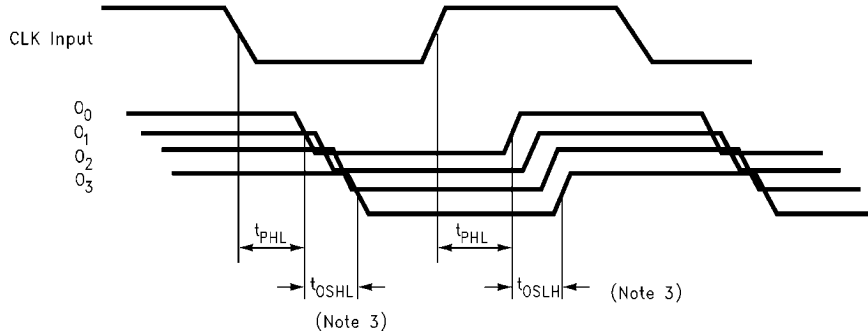

Test Circuit

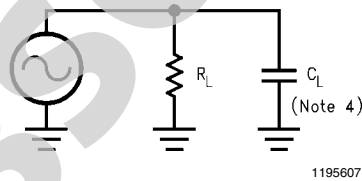

R_L is 500 Ω
 C_L is 50 pF for all propagation delays and skew measurements.

Ordering Information

(Contact NSC Marketing for specific date of availability)

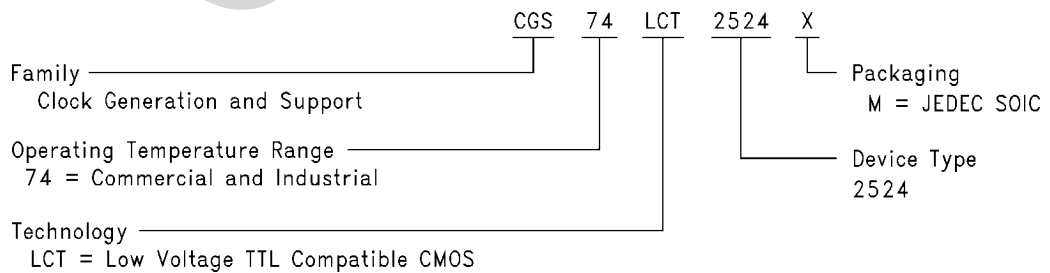

1195608

Physical Dimensions inches (millimeters) unless otherwise noted

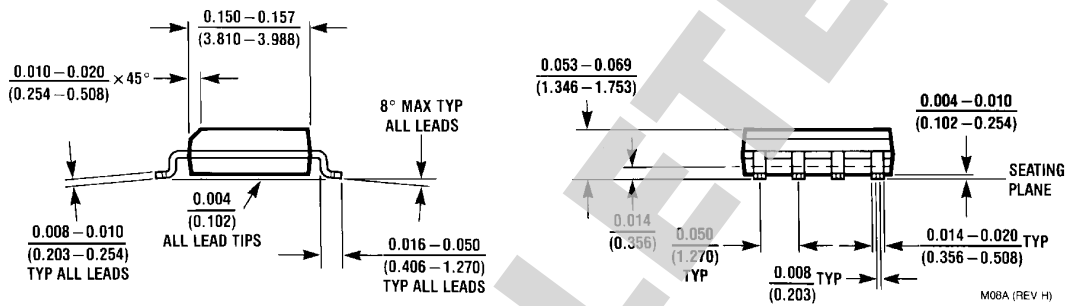
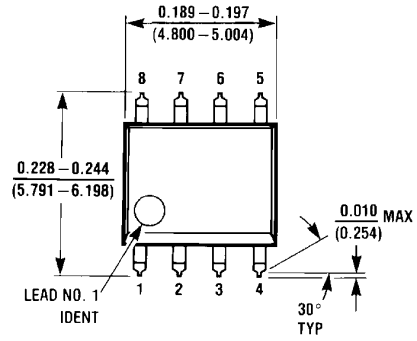

8-Lead (0.150 Wide) Molded Small Outline Package, JEDEC
Order Number CGS74LCT2524M
NS Package Number M08A

OBSOLETE

Notes

For more National Semiconductor product information and proven design tools, visit the following Web sites at:
www.national.com

Products		Design Support	
Amplifiers	www.national.com/amplifiers	WEBENCH® Tools	www.national.com/webench
Audio	www.national.com/audio	App Notes	www.national.com/appnotes
Clock and Timing	www.national.com/timing	Reference Designs	www.national.com/refdesigns
Data Converters	www.national.com/adc	Samples	www.national.com/samples
Interface	www.national.com/interface	Eval Boards	www.national.com/evalboards
LVDS	www.national.com/lvds	Packaging	www.national.com/packaging
Power Management	www.national.com/power	Green Compliance	www.national.com/quality/green
Switching Regulators	www.national.com/switchers	Distributors	www.national.com/contacts
LDOs	www.national.com/ldo	Quality and Reliability	www.national.com/quality
LED Lighting	www.national.com/led	Feedback/Support	www.national.com/feedback
Voltage References	www.national.com/vref	Design Made Easy	www.national.com/easy
PowerWise® Solutions	www.national.com/powerwise	Applications & Markets	www.national.com/solutions
Serial Digital Interface (SDI)	www.national.com/sdi	Mil/Aero	www.national.com/milaero
Temperature Sensors	www.national.com/tempensors	SolarMagic™	www.national.com/solarmagic
PLL/VCO	www.national.com/wireless	PowerWise® Design University	www.national.com/training

THE CONTENTS OF THIS DOCUMENT ARE PROVIDED IN CONNECTION WITH NATIONAL SEMICONDUCTOR CORPORATION ("NATIONAL") PRODUCTS. NATIONAL MAKES NO REPRESENTATIONS OR WARRANTIES WITH RESPECT TO THE ACCURACY OR COMPLETENESS OF THE CONTENTS OF THIS PUBLICATION AND RESERVES THE RIGHT TO MAKE CHANGES TO SPECIFICATIONS AND PRODUCT DESCRIPTIONS AT ANY TIME WITHOUT NOTICE. NO LICENSE, WHETHER EXPRESS, IMPLIED, ARISING BY ESTOPPEL OR OTHERWISE, TO ANY INTELLECTUAL PROPERTY RIGHTS IS GRANTED BY THIS DOCUMENT.

TESTING AND OTHER QUALITY CONTROLS ARE USED TO THE EXTENT NATIONAL DEEMS NECESSARY TO SUPPORT NATIONAL'S PRODUCT WARRANTY. EXCEPT WHERE MANDATED BY GOVERNMENT REQUIREMENTS, TESTING OF ALL PARAMETERS OF EACH PRODUCT IS NOT NECESSARILY PERFORMED. NATIONAL ASSUMES NO LIABILITY FOR APPLICATIONS ASSISTANCE OR BUYER PRODUCT DESIGN. BUYERS ARE RESPONSIBLE FOR THEIR PRODUCTS AND APPLICATIONS USING NATIONAL COMPONENTS. PRIOR TO USING OR DISTRIBUTING ANY PRODUCTS THAT INCLUDE NATIONAL COMPONENTS, BUYERS SHOULD PROVIDE ADEQUATE DESIGN, TESTING AND OPERATING SAFEGUARDS.

EXCEPT AS PROVIDED IN NATIONAL'S TERMS AND CONDITIONS OF SALE FOR SUCH PRODUCTS, NATIONAL ASSUMES NO LIABILITY WHATSOEVER, AND NATIONAL DISCLAIMS ANY EXPRESS OR IMPLIED WARRANTY RELATING TO THE SALE AND/OR USE OF NATIONAL PRODUCTS INCLUDING LIABILITY OR WARRANTIES RELATING TO FITNESS FOR A PARTICULAR PURPOSE, MERCHANTABILITY, OR INFRINGEMENT OF ANY PATENT, COPYRIGHT OR OTHER INTELLECTUAL PROPERTY RIGHT.

LIFE SUPPORT POLICY

NATIONAL'S PRODUCTS ARE NOT AUTHORIZED FOR USE AS CRITICAL COMPONENTS IN LIFE SUPPORT DEVICES OR SYSTEMS WITHOUT THE EXPRESS PRIOR WRITTEN APPROVAL OF THE CHIEF EXECUTIVE OFFICER AND GENERAL COUNSEL OF NATIONAL SEMICONDUCTOR CORPORATION. As used herein:

Life support devices or systems are devices which (a) are intended for surgical implant into the body, or (b) support or sustain life and whose failure to perform when properly used in accordance with instructions for use provided in the labeling can be reasonably expected to result in a significant injury to the user. A critical component is any component in a life support device or system whose failure to perform can be reasonably expected to cause the failure of the life support device or system or to affect its safety or effectiveness.

National Semiconductor and the National Semiconductor logo are registered trademarks of National Semiconductor Corporation. All other brand or product names may be trademarks or registered trademarks of their respective holders.

Copyright© 2011 National Semiconductor Corporation

For the most current product information visit us at www.national.com



www.national.com

**National Semiconductor
Americas Technical
Support Center**
Email: support@nsc.com
Tel: 1-800-272-9959

**National Semiconductor Europe
Technical Support Center**
Email: europe.support@nsc.com

**National Semiconductor Asia
Pacific Technical Support Center**
Email: ap.support@nsc.com

**National Semiconductor Japan
Technical Support Center**
Email: jpn.feedback@nsc.com

IMPORTANT NOTICE

Texas Instruments Incorporated and its subsidiaries (TI) reserve the right to make corrections, modifications, enhancements, improvements, and other changes to its products and services at any time and to discontinue any product or service without notice. Customers should obtain the latest relevant information before placing orders and should verify that such information is current and complete. All products are sold subject to TI's terms and conditions of sale supplied at the time of order acknowledgment.

TI warrants performance of its hardware products to the specifications applicable at the time of sale in accordance with TI's standard warranty. Testing and other quality control techniques are used to the extent TI deems necessary to support this warranty. Except where mandated by government requirements, testing of all parameters of each product is not necessarily performed.

TI assumes no liability for applications assistance or customer product design. Customers are responsible for their products and applications using TI components. To minimize the risks associated with customer products and applications, customers should provide adequate design and operating safeguards.

TI does not warrant or represent that any license, either express or implied, is granted under any TI patent right, copyright, mask work right, or other TI intellectual property right relating to any combination, machine, or process in which TI products or services are used. Information published by TI regarding third-party products or services does not constitute a license from TI to use such products or services or a warranty or endorsement thereof. Use of such information may require a license from a third party under the patents or other intellectual property of the third party, or a license from TI under the patents or other intellectual property of TI.

Reproduction of TI information in TI data books or data sheets is permissible only if reproduction is without alteration and is accompanied by all associated warranties, conditions, limitations, and notices. Reproduction of this information with alteration is an unfair and deceptive business practice. TI is not responsible or liable for such altered documentation. Information of third parties may be subject to additional restrictions.

Resale of TI products or services with statements different from or beyond the parameters stated by TI for that product or service voids all express and any implied warranties for the associated TI product or service and is an unfair and deceptive business practice. TI is not responsible or liable for any such statements.

TI products are not authorized for use in safety-critical applications (such as life support) where a failure of the TI product would reasonably be expected to cause severe personal injury or death, unless officers of the parties have executed an agreement specifically governing such use. Buyers represent that they have all necessary expertise in the safety and regulatory ramifications of their applications, and acknowledge and agree that they are solely responsible for all legal, regulatory and safety-related requirements concerning their products and any use of TI products in such safety-critical applications, notwithstanding any applications-related information or support that may be provided by TI. Further, Buyers must fully indemnify TI and its representatives against any damages arising out of the use of TI products in such safety-critical applications.

TI products are neither designed nor intended for use in military/aerospace applications or environments unless the TI products are specifically designated by TI as military-grade or "enhanced plastic." Only products designated by TI as military-grade meet military specifications. Buyers acknowledge and agree that any such use of TI products which TI has not designated as military-grade is solely at the Buyer's risk, and that they are solely responsible for compliance with all legal and regulatory requirements in connection with such use.

TI products are neither designed nor intended for use in automotive applications or environments unless the specific TI products are designated by TI as compliant with ISO/TS 16949 requirements. Buyers acknowledge and agree that, if they use any non-designated products in automotive applications, TI will not be responsible for any failure to meet such requirements.

Following are URLs where you can obtain information on other Texas Instruments products and application solutions:

Products

Audio	www.ti.com/audio
Amplifiers	amplifier.ti.com
Data Converters	dataconverter.ti.com
DLP® Products	www.dlp.com
DSP	dsp.ti.com
Clocks and Timers	www.ti.com/clocks
Interface	interface.ti.com
Logic	logic.ti.com
Power Mgmt	power.ti.com
Microcontrollers	microcontroller.ti.com
RFID	www.ti-rfid.com
OMAP Mobile Processors	www.ti.com/omap
Wireless Connectivity	www.ti.com/wirelessconnectivity

Applications

Communications and Telecom	www.ti.com/communications
Computers and Peripherals	www.ti.com/computers
Consumer Electronics	www.ti.com/consumer-apps
Energy and Lighting	www.ti.com/energy
Industrial	www.ti.com/industrial
Medical	www.ti.com/medical
Security	www.ti.com/security
Space, Avionics and Defense	www.ti.com/space-avionics-defense
Transportation and Automotive	www.ti.com/automotive
Video and Imaging	www.ti.com/video

TI E2E Community Home Page

e2e.ti.com

Mailing Address: Texas Instruments, Post Office Box 655303, Dallas, Texas 75265
Copyright © 2011, Texas Instruments Incorporated







Looking for pricing, stock, or lifecycle information?

Click below to explore more details on WIN SOURCE:

 [View CGS74LCT2524M on WIN SOURCE](#)

 [Texas Instruments](#) Information

Optimize Your Supply Chain with WIN SOURCE Solutions

-  Global Sourcing Solution
-  Obsolete Management
-  Cost Control Management
-  Shortage Management
-  Alternative Solution
-  Excess Inventory Management