



# THE DATASHEET OF CGS74C2525MX



# **CGS74C2525,CGS74C2526,CGS74CT2525, CGS74CT2526**

*CGS74CT2525 1-to-8 Minimum Skew Clock Driver*



Literature Number: SNOS559

## CGS74C2525 • CGS74CT2525 CGS74C2526 • CGS74CT2526 1-to-8 Minimum Skew Clock Driver

The CGS 'C/CT2525 is a minimum skew clock driver with one input driving eight outputs specifically designed for signal generation and clock distribution applications. The '2525 is designed to distribute a single clock to eight separate receivers with low skew across all outputs during both the  $t_{PLH}$  and  $t_{PHL}$  transitions. The '2526 is similar to the '2525 but contains a multiplexed clock input to allow for systems with dual clock speeds or systems where a separate test clock has been implemented.

### Features

- These CGS devices implement National's FACT™ family
- Ideal for signal generation and clock distribution
- Guaranteed pin to pin and part to part skew
- Multiplexed clock input ('2526)
- Guaranteed 2 kV minimum ESD protection
- Symmetric output current drive of 24 mA for  $I_{OL}/I_{OH}$
- 'CT has TTL-compatible inputs
- These products are identical to 74AC/ACT2525 and 2526
- Available as Mil/Aero versions  
54AC/ACT2525  
54AC/ACT2526

### Logic Symbols

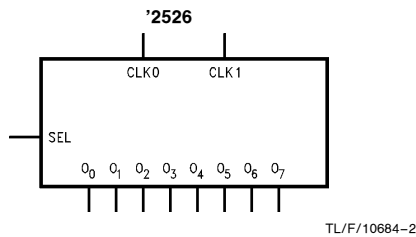
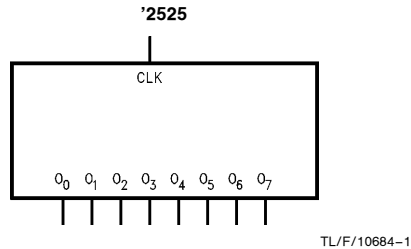

### Connection Diagrams

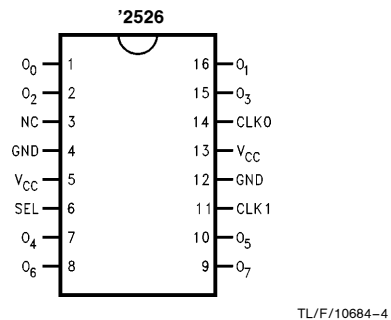
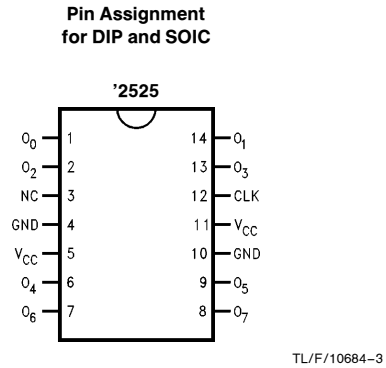

TRI-STATE® is a registered trademark of National Semiconductor Corporation.  
FACT™ is a trademark of National Semiconductor Corporation.

## Functional Description

On the multiplexed clock device, the SEL pin is used to determine which CLKn input will have an active effect on the outputs of the circuit. When SEL = 1, the CLK1 input is selected and when SEL = 0, the CLK0 input is selected. The non-selected CLKn input will not have any effect on the logical output level of the circuit. The output pins act as a single entity and will follow the state of the CLK or CLK1/CLK0 pins when either the multiplexed ('2526) or the straight ('2525) clock distribution chip is selected.

### Pin Description

Pin Names	Description
CLK	Clock Input ('2525)
CLK0, CLK1	Clock Inputs ('2526)
O <sub>0</sub> -O <sub>7</sub>	Outputs
SEL	Clock Select ('2526)

## Truth Tables

'2525

Inputs	Outputs
CLK	O <sub>0</sub> -O <sub>7</sub>
L	L
H	H

'2526

Inputs			Outputs
CLK0	CLK1	SEL	O <sub>0</sub> -O <sub>7</sub>
L	X	L	L
H	X	L	H
X	L	H	L
X	H	H	H

L = Low Voltage Level

H = High Voltage Level

X = Immaterial

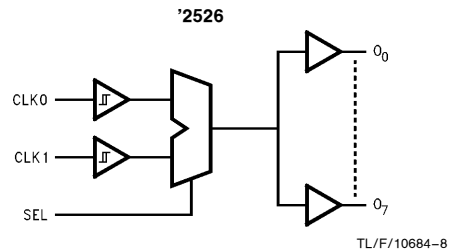
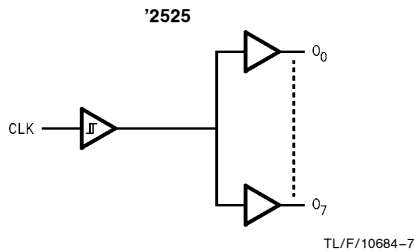

## Absolute Maximum Ratings (Note 1)

If Military/Aerospace specified devices are required, please contact the National Semiconductor Sales Office/Distributors for availability and specifications.

Supply Voltage ( $V_{CC}$ )	-0.5V to +7.0V
DC Input Diode Current ( $I_{IK}$ )	-20 mA
$V_I = -0.5V$	
$V_I = V_{CC} + 0.5V$	+0.2 mA
DC Input Voltage ( $V_I$ )	-0.5V to ( $V_{CC} + 0.5V$ )
DC Output Diode Current ( $I_{OK}$ )	-20 mA
$V_O = 0.5V$	
$V_O = V_{CC} + 0.5V$	+20 mA
DC Output Voltage ( $V_O$ )	-0.5V to ( $V_{CC} + 0.5V$ )
DC Output Source or Sink Current ( $I_O$ )	$\pm 50$ mA
DC $V_{CC}$ or Ground Current per Output Pin ( $I_{CC}$ or $I_{GND}$ )	$\pm 50$ mA
Storage Temperature ( $T_{STG}$ )	-65°C to +150°C
Junction Temperature ( $\theta_{JA}$ )	
Plastic (N) 14-Lead	102°C/W
Plastic (M) 14-Lead	128°C/W
Plastic (N) 16-Lead	97°C/W
Plastic (M) 16-Lead	124°C/W

## Recommended Operating Conditions

Supply Voltage ( $V_{CC}$ )	2.0V to 6.0V
'C'	4.5V to 5.5V
'CT'	
Input Voltage ( $V_I$ )	0V to $V_{CC}$
Output Voltage ( $V_O$ )	0V to $V_{CC}$
Operating Temperature ( $T_A$ )	
CGS74C/CT	-40°C to +85°C
54AC/ACT	-55°C to +125°C
Input Rise and Fall Times Devices (30% to 70% of $V_{CC}$ )	
$V_{CC} = 3.3V$	10.5 ns max
4.5V	14.4 ns max
5.5V	17.6 ns max
Input Rise and Fall Times Devices (0.8V to 2.0V)	9.6 ns max

**Note 1:** Absolute maximum ratings are those values beyond which damage to the device may occur. The databook specifications should be met, without exception, to ensure that the system design is reliable over its power supply, temperature, and output/input loading variables. National does not recommend operation of CGS circuits outside databook specifications.

## DC Electrical Characteristics for CGS74C and 54AC Family Devices

Over recommended operating conditions unless specified otherwise.

Symbol	Parameter	$V_{CC}$ (V)	CGS74C		54AC	CGS74C		Units	Conditions
			$T_A = +25^\circ\text{C}$		$T_A = -55^\circ\text{C to } +125^\circ\text{C}$	$T_A = -40^\circ\text{C to } +85^\circ\text{C}$			
			Typ		Guaranteed Limits				
$V_{IH}$	Minimum High Level Input Voltage	3.0	1.5	2.1	2.1	2.1	2.1	V	$V_{OUT} = 0.1V$ or $V_{CC} - 0.1V$
		4.5	2.25	3.15	3.15	3.15	3.15		
		5.5	2.75	3.85	3.85	3.85	3.85		
$V_{IL}$	Maximum Low Level Input Voltage	3.0	1.5	0.9	0.9	0.9	0.9	V	$V_{OUT} = 0.1V$ or $V_{CC} - 0.1V$
		4.5	2.25	1.35	1.35	1.35	1.35		
		5.5	2.75	1.65	1.65	1.65	1.65		
$V_{OH}$	Minimum High Level Output Voltage (Note 2)	3.0	2.99	2.9	2.9	2.9	2.9	V	$I_{OUT} = -50 \mu\text{A}$
		4.5	4.49	4.4	4.4	4.4	4.4		
		5.5	5.49	5.4	5.4	5.4	5.4		
		3.0		2.56	2.4	2.46	2.46	V	$V_{IN} = V_{IL}$ or $V_{IH}$ -12 mA $I_{OH}$ -24 mA -24 mA
		4.5		3.86	3.7	3.76	3.76		
		5.5		4.86	4.7	4.76	4.76		
$V_{OL}$	Maximum Low Level Output Voltage (Note 2)	3.0	0.002	0.1	0.1	0.1	0.1	V	$I_{OUT} = 50 \mu\text{A}$
		4.5	0.001	0.1	0.1	0.1	0.1		
		5.5	0.001	0.1	0.1	0.1	0.1		
		3.0		0.36	0.40	0.44	0.44	V	$V_{IN} = V_{IL}$ or $V_{IH}$ 12 mA 24 mA $I_{OL}$ 24 mA
		4.5		0.36	0.50	0.44	0.44		
		5.5		0.36	0.50	0.44	0.44		

### DC Electrical Characteristics for CGS74C and 54AC Family Devices (Continued)

Over recommended operating conditions unless specified otherwise.

Symbol	Parameter	V <sub>CC</sub> (V)	CGS74C		54AC	CGS74C		Units	Conditions
			T <sub>A</sub> = +25°C		T <sub>A</sub> = -55°C to +125°C	T <sub>A</sub> = -40°C to +85°C			
			Typ	Guaranteed Limits					
I <sub>IN</sub>	Maximum Input Leakage Current (Note 3)	5.5		±0.1	±1.0	±1.0		μA	V <sub>I</sub> = V <sub>CC</sub> , GND
I <sub>OLD</sub>	Minimum Dynamic Output Current (Note 4)	5.5			50	75		mA	V <sub>OLD</sub> = 1.65V Max
I <sub>OHD</sub>	Maximum Output Current (Note 4)	5.5			-50	-75		mA	V <sub>OHD</sub> = 3.85V Min
I <sub>CC</sub>	Maximum Quiescent Supply Current (Note 3)	5.5		8.0	80.0	80.0		μA	V <sub>IN</sub> = V <sub>CC</sub> or GND

### DC Electrical Characteristics for CGS74CT and 54ACT Family Devices

Over recommended operating conditions unless specified otherwise.

Symbol	Parameter	V <sub>CC</sub> (V)	CGS74CT		54ACT	CGS74CT		Units	Conditions
			T <sub>A</sub> = +25°C		T <sub>A</sub> = -55°C to +125°C	T <sub>A</sub> = -40°C to +85°C			
			Typ	Guaranteed Limits					
V <sub>IH</sub>	Minimum High Level Input Voltage	4.5	1.5	2.0	2.0	2.0		V	V <sub>OUT</sub> = 0.1V or V <sub>CC</sub> - 0.1V
		5.5	1.5	2.0	2.0	2.0			
V <sub>IL</sub>	Maximum Low Level Input Voltage	4.5	1.5	0.8	0.8	0.8		V	V <sub>OUT</sub> = 0.1V or V <sub>CC</sub> - 0.1V
		5.5	1.5	0.8	0.8	0.8			
V <sub>OH</sub>	Minimum High Level Output Voltage (Note 2)	4.5	4.49	4.4	4.4	4.4		V	I <sub>OUT</sub> = -50 μA
		5.5	5.49	5.4	5.4	5.4			
		4.5		3.86	3.70	3.76		V	V <sub>IN</sub> = V <sub>IL</sub> or V <sub>IH</sub> -24 mA I <sub>OH</sub> -24 mA
		5.5		4.86	4.70	4.76			
V <sub>OL</sub>	Maximum Low Level Output Voltage (Note 2)	4.5	0.001	0.1	0.1	0.1		V	I <sub>OUT</sub> = 50 μA
		5.5	0.001	0.1	0.1	0.1			
		4.5		0.36	0.50	0.44		V	V <sub>IN</sub> = V <sub>IL</sub> or V <sub>IH</sub> 24 mA I <sub>OL</sub> 24 mA
5.5		0.36	0.50	0.44					
I <sub>IN</sub>	Maximum Input Leakage Current	5.5		±0.1	±1.0	±1.0		μA	V <sub>I</sub> = V <sub>CC</sub> , GND
I <sub>CCCT</sub>	Maximum I <sub>CC</sub> /Input	5.5	0.6		1.6	1.5		mA	V <sub>I</sub> = V <sub>CC</sub> - 2.1V
I <sub>OLD</sub>	Minimum Dynamic Output Current (Note 4)	5.5			50	75		mA	V <sub>OLD</sub> = 1.65V Max
I <sub>OHD</sub>	Maximum Output Current (Note 4)	5.5			-50	-75		mA	V <sub>OHD</sub> = 3.85V Min
I <sub>CC</sub>	Maximum Quiescent Supply Current (Note 5)	5.5		8.0	160.0	80.0		μA	V <sub>IN</sub> = V <sub>CC</sub> or GND

**AC Electrical Characteristics** Over recommended operating conditions unless specified otherwise.

Symbol	Parameter	V <sub>CC</sub> Range (V) (Note 6)	CGS74C			54AC		CGS74C			Units
			T <sub>A</sub> = +25°C C <sub>L</sub> = 50 pF			T <sub>A</sub> = -55°C to +125°C C <sub>L</sub> = 50 pF		T <sub>A</sub> = -40°C to +85°C C <sub>L</sub> = 50 pF			
			Min	Typ	Max	Min	Max	Min	Typ	Max	
t <sub>PLH</sub> , t <sub>PHL</sub>	Propagation Delay CLK to O <sub>n</sub> ('2525)	3.3 5.0	3.0 3.2	6.5 5.0	11.0 7.8	3.0 2.5	11.0 8.2	3.0 2.9	12.5 8.1	ns	
t <sub>PLH</sub> , t <sub>PHL</sub>	Propagation Delay CLKn to O <sub>n</sub> ('2526)	3.3 5.0	3.0 3.6	7.0 5.5	13.0 7.8			3.0 3.3	14.0 8.6	ns	
t <sub>PLH</sub> , t <sub>PHL</sub>	Propagation Delay SEL to O <sub>n</sub> ('2526)	3.3 5.0	3.0 4.0	8.0 6.5	14.0 8.5			3.0 3.5	15.0 9.5	ns	
t <sub>OSHL</sub>	Maximum Skew Common Edge Output-to-Output (Note 7) Variation	3.3 5.0	0.3			1.5 1.0		600 500			ps
t <sub>OSLH</sub>	Maximum Skew Common Edge Output-to-Output (Note 7) Variation	3.3 5.0	0.3			1.5 1.0		600 500			ps
t <sub>OST</sub>	Maximum Skew Opposite Edge Output-to-Output (Note 7) Variation	5.0	0.4 1.0			1.5 1.0		1.0			ns
t <sub>PV</sub>	Maximum Skew Part-to-Part Variation (Note 8)	'C2525 'CT2525 'C2526	5.0			3.5 4.0					ns
t <sub>rise</sub> , t <sub>fall</sub>	Maximum Rise/Fall Time (20% to 80% V <sub>CC</sub> )	5.0	3.0			4.0		3.75			ns
t <sub>rise</sub> , t <sub>fall</sub>	Maximum Rise/Fall Time (0.8V/2.0V and 2.0V/0.8V)		0.9					1.1			ns

**AC Electrical Characteristics** Over recommended operating conditions unless specified otherwise.

Symbol	Parameter	V <sub>CC</sub> Range (V) (Note 6)	CGS74CT			54ACT		CGS74CT		Units
			T <sub>A</sub> = +25°C C <sub>L</sub> = 50 pF			T <sub>A</sub> = -55°C to +125°C C <sub>L</sub> = 50 pF		T <sub>A</sub> = -40°C to +85°C C <sub>L</sub> = 50 pF		
			Min	Typ	Max	Min	Max	Min	Max	
t <sub>PLH</sub> , t <sub>PHL</sub>	Propagation Delay CLK to O <sub>n</sub> ('2525)	5.0	4.6	6.5	9.0			4.0	10.1	ns
t <sub>PLH</sub> , t <sub>PHL</sub>	Propagation Delay CLKn to O <sub>n</sub> ('2526)	5.0	5.8	8.5	11.1			5.1	12.4	ns

## AC Electrical Characteristics

Over recommended operating conditions unless specified otherwise. (Continued)

Symbol	Parameter	V <sub>CC</sub> Range (V) (Note 6)	CGS74CT			54ACT		CGS74CT			Units
			T <sub>A</sub> = +25°C C <sub>L</sub> = 50 pF			T <sub>A</sub> = -55°C to +125°C C <sub>L</sub> = 50 pF		T <sub>A</sub> = -40°C to +85°C C <sub>L</sub> = 50 pF			
			Min	Typ	Max	Min	Max	Min	Typ	Max	
t <sub>PLH</sub> , t <sub>PHL</sub>	Propagation Delay SEL to O <sub>n</sub> ('2526)	5.0	5.1	8.5	12.4			4.4	14.1	ns	
t <sub>OSHL</sub>	Maximum Skew Common Edge Output-to-Output (Note 7) Variation	5.0		0.2					550	ps	
t <sub>OSLH</sub>	Maximum Skew Common Edge Output-to-Output (Note 7) Variation	5.0		0.2					550	ps	
t <sub>OST</sub>	Maximum Skew Opposite Edge Output-to-Output (Note 7) Variation	5.0		0.4					1.0	ns	
t <sub>PV</sub>	Maximum Skew Part-to-Part Variation (Note 8)	AC2525									
		AC2525	5.0		3.5					ns	
		AC2526	5.0		5.0					ns	
t <sub>rise</sub> , t <sub>fall</sub>	Maximum Rise/Fall Time (20% to 80% V <sub>CC</sub> )	5.0		3.0				3.75		ns	
t <sub>rise</sub> , t <sub>fall</sub>	Maximum Rise/Fall Time (0.8V/2.0V and 2.0V/0.8V)			0.9				1.1		ns	

**Note 2:** All outputs loaded; thresholds on input associated with output under test.

**Note 3:** I<sub>IN</sub> and I<sub>CC</sub> @ 3.0V are guaranteed to be less than or equal to the respective limit @ 5.5V V<sub>CC</sub>.

I<sub>CC</sub> for 54AC @ 25°C is identical to CGS74C @ 25°C.

**Note 4:** Maximum test duration 2.0 ms, one output loaded at a time.

**Note 5:** I<sub>CC</sub> for 54ACT @ 25°C is identical to CGS74CT @ 25°C.

**Note 6:** Voltage Range 5.0 is 5.0V ±0.5V, voltage range 3.3 is 3.3V ±0.3V.

**Note 7:** Output-to-Output Skew is defined as the absolute value of the difference between the actual propagation delay for any outputs within the same packaged device. The specifications apply to any outputs switching in the same direction either HIGH to LOW (t<sub>OSHL</sub>) or LOW to HIGH (t<sub>OSLH</sub>) or in opposite directions both HL and LH (t<sub>OST</sub>). t<sub>OSHL</sub> and t<sub>OSLH</sub> are characterized and guaranteed by design @ 1 MHz.

**Note 8:** Part-to-part skew is defined as the absolute value of the difference between the propagation delay for any outputs from device to device. The parameter is specified for a given set of conditions (i.e., capacitive load, V<sub>CC</sub>, temperature, # of outputs switching, etc.). Parameter guaranteed by design.

**Note 9:** Load capacitance includes the test jig.

## Capacitance

Symbol	Parameter	Typ	Units	Conditions
$C_{IN}$	Input Capacitance	4.5	pF	$V_{CC} = 5.0V$
$C_{PD}$	Power Dissipation Capacitance ('2525)	$820 \text{ pF} - 1.2 \times 10^{-18} (f)^*$	pF	$V_{CC} = 5.0V$
$C_{PD}$	Power Dissipation Capacitance ('2526)	$820 \text{ pF} - 1.2 \times 10^{-18} (f)^*$	pF	$V_{CC} = 5.0V$

\*f = frequency

### Recommended Maximum Power Dissipation (W)

LFPM	$T_A = 25^\circ\text{C}$		$T_A = 85^\circ\text{C}$	
	PDIP	SOIC	PDIP	SOIC
0	1.105	0.858	0.528	0.41
225	1.493	1.055	0.714	0.504
500	1.71	1.210	0.820	0.578

## Timing Diagrams

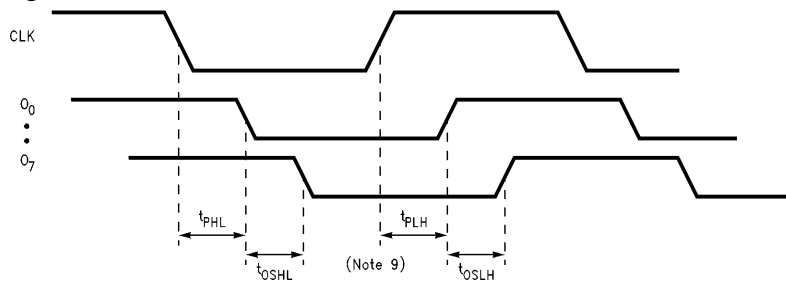

TL/F/10684-27

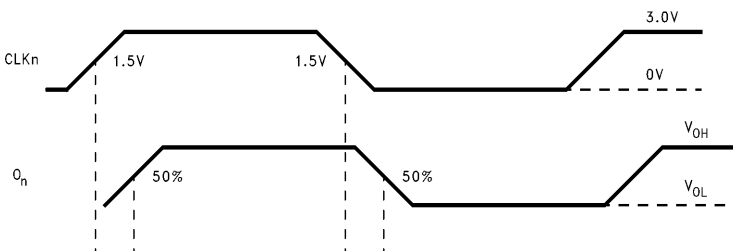

TL/F/10684-28

## Test Circuit

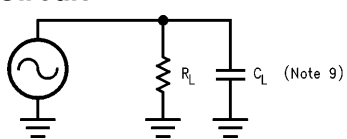

$R_L$  is  $500\Omega$   
 $C_L$  is 50 pF for all prop delays and skew measurements.

TL/F/10684-29

## Ordering Information

The device number is used to form part of a simplified purchasing code where the package type and temperature range are defined as follows:

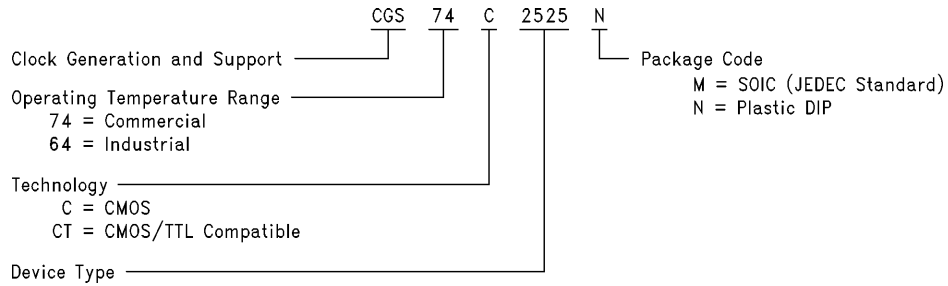

TL/F/10684-26

## Physical Dimensions inches (millimeters) unless otherwise noted

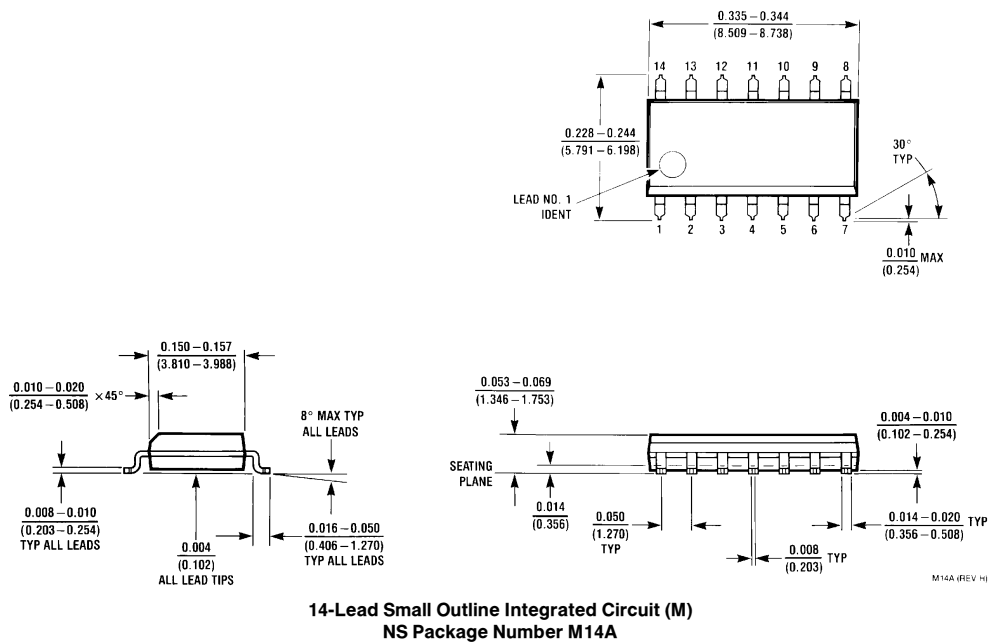



**Physical Dimensions** inches (millimeters) unless otherwise noted (Continued)

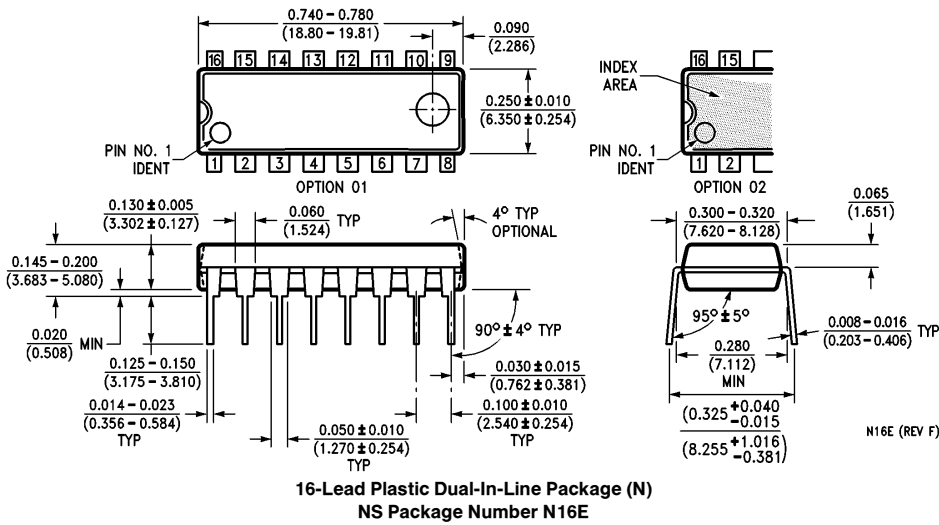

**LIFE SUPPORT POLICY**

NATIONAL'S PRODUCTS ARE NOT AUTHORIZED FOR USE AS CRITICAL COMPONENTS IN LIFE SUPPORT DEVICES OR SYSTEMS WITHOUT THE EXPRESS WRITTEN APPROVAL OF THE PRESIDENT OF NATIONAL SEMICONDUCTOR CORPORATION. As used herein:

1. Life support devices or systems are devices or systems which, (a) are intended for surgical implant into the body, or (b) support or sustain life, and whose failure to perform, when properly used in accordance with instructions for use provided in the labeling, can be reasonably expected to result in a significant injury to the user.
2. A critical component is any component of a life support device or system whose failure to perform can be reasonably expected to cause the failure of the life support device or system, or to affect its safety or effectiveness.

 <p> <b>National Semiconductor Corporation</b>                  1111 West Bardin Road                  Arlington, TX 76017                  Tel: (800) 272-9959                  Fax: (800) 737-7018  <a href="http://www.national.com">http://www.national.com</a> </p>	<p> <b>National Semiconductor Europe</b>                  Fax: +49 (0) 180-530 85 86                  Email: <a href="mailto:europe.support@nsc.com">europe.support@nsc.com</a>                  Deutsch Tel: +49 (0) 180-530 85 85                  English Tel: +49 (0) 180-532 78 32                  Français Tel: +49 (0) 180-532 93 58                  Italiano Tel: +49 (0) 180-534 16 80             </p>	<p> <b>National Semiconductor Hong Kong Ltd.</b>                  19th Floor, Straight Block,                  Ocean Centre, 5 Canton Rd.                  Tsimshatsui, Kowloon                  Hong Kong                  Tel: (852) 2737-1600                  Fax: (852) 2736-9960             </p>	<p> <b>National Semiconductor Japan Ltd.</b>                  Tel: 81-043-299-2308                  Fax: 81-043-299-2408             </p>
---	--	---	---

National does not assume any responsibility for use of any circuitry described, no circuit patent licenses are implied and National reserves the right at any time without notice to change said circuitry and specifications.

## IMPORTANT NOTICE

Texas Instruments Incorporated and its subsidiaries (TI) reserve the right to make corrections, modifications, enhancements, improvements, and other changes to its products and services at any time and to discontinue any product or service without notice. Customers should obtain the latest relevant information before placing orders and should verify that such information is current and complete. All products are sold subject to TI's terms and conditions of sale supplied at the time of order acknowledgment.

TI warrants performance of its hardware products to the specifications applicable at the time of sale in accordance with TI's standard warranty. Testing and other quality control techniques are used to the extent TI deems necessary to support this warranty. Except where mandated by government requirements, testing of all parameters of each product is not necessarily performed.

TI assumes no liability for applications assistance or customer product design. Customers are responsible for their products and applications using TI components. To minimize the risks associated with customer products and applications, customers should provide adequate design and operating safeguards.

TI does not warrant or represent that any license, either express or implied, is granted under any TI patent right, copyright, mask work right, or other TI intellectual property right relating to any combination, machine, or process in which TI products or services are used. Information published by TI regarding third-party products or services does not constitute a license from TI to use such products or services or a warranty or endorsement thereof. Use of such information may require a license from a third party under the patents or other intellectual property of the third party, or a license from TI under the patents or other intellectual property of TI.

Reproduction of TI information in TI data books or data sheets is permissible only if reproduction is without alteration and is accompanied by all associated warranties, conditions, limitations, and notices. Reproduction of this information with alteration is an unfair and deceptive business practice. TI is not responsible or liable for such altered documentation. Information of third parties may be subject to additional restrictions.

Resale of TI products or services with statements different from or beyond the parameters stated by TI for that product or service voids all express and any implied warranties for the associated TI product or service and is an unfair and deceptive business practice. TI is not responsible or liable for any such statements.

TI products are not authorized for use in safety-critical applications (such as life support) where a failure of the TI product would reasonably be expected to cause severe personal injury or death, unless officers of the parties have executed an agreement specifically governing such use. Buyers represent that they have all necessary expertise in the safety and regulatory ramifications of their applications, and acknowledge and agree that they are solely responsible for all legal, regulatory and safety-related requirements concerning their products and any use of TI products in such safety-critical applications, notwithstanding any applications-related information or support that may be provided by TI. Further, Buyers must fully indemnify TI and its representatives against any damages arising out of the use of TI products in such safety-critical applications.

TI products are neither designed nor intended for use in military/aerospace applications or environments unless the TI products are specifically designated by TI as military-grade or "enhanced plastic." Only products designated by TI as military-grade meet military specifications. Buyers acknowledge and agree that any such use of TI products which TI has not designated as military-grade is solely at the Buyer's risk, and that they are solely responsible for compliance with all legal and regulatory requirements in connection with such use.

TI products are neither designed nor intended for use in automotive applications or environments unless the specific TI products are designated by TI as compliant with ISO/TS 16949 requirements. Buyers acknowledge and agree that, if they use any non-designated products in automotive applications, TI will not be responsible for any failure to meet such requirements.

Following are URLs where you can obtain information on other Texas Instruments products and application solutions:

### Products

Audio	<a href="http://www.ti.com/audio">www.ti.com/audio</a>
Amplifiers	<a href="http://amplifier.ti.com">amplifier.ti.com</a>
Data Converters	<a href="http://dataconverter.ti.com">dataconverter.ti.com</a>
DLP® Products	<a href="http://www.dlp.com">www.dlp.com</a>
DSP	<a href="http://dsp.ti.com">dsp.ti.com</a>
Clocks and Timers	<a href="http://www.ti.com/clocks">www.ti.com/clocks</a>
Interface	<a href="http://interface.ti.com">interface.ti.com</a>
Logic	<a href="http://logic.ti.com">logic.ti.com</a>
Power Mgmt	<a href="http://power.ti.com">power.ti.com</a>
Microcontrollers	<a href="http://microcontroller.ti.com">microcontroller.ti.com</a>
RFID	<a href="http://www.ti-rfid.com">www.ti-rfid.com</a>
OMAP Mobile Processors	<a href="http://www.ti.com/omap">www.ti.com/omap</a>
Wireless Connectivity	<a href="http://www.ti.com/wirelessconnectivity">www.ti.com/wirelessconnectivity</a>

### Applications

Communications and Telecom	<a href="http://www.ti.com/communications">www.ti.com/communications</a>
Computers and Peripherals	<a href="http://www.ti.com/computers">www.ti.com/computers</a>
Consumer Electronics	<a href="http://www.ti.com/consumer-apps">www.ti.com/consumer-apps</a>
Energy and Lighting	<a href="http://www.ti.com/energy">www.ti.com/energy</a>
Industrial	<a href="http://www.ti.com/industrial">www.ti.com/industrial</a>
Medical	<a href="http://www.ti.com/medical">www.ti.com/medical</a>
Security	<a href="http://www.ti.com/security">www.ti.com/security</a>
Space, Avionics and Defense	<a href="http://www.ti.com/space-avionics-defense">www.ti.com/space-avionics-defense</a>
Transportation and Automotive	<a href="http://www.ti.com/automotive">www.ti.com/automotive</a>
Video and Imaging	<a href="http://www.ti.com/video">www.ti.com/video</a>

TI E2E Community Home Page

[e2e.ti.com](http://e2e.ti.com)

Mailing Address: Texas Instruments, Post Office Box 655303, Dallas, Texas 75265  
Copyright © 2011, Texas Instruments Incorporated

## Looking for pricing, stock, or lifecycle information?

Click below to explore more details on WIN SOURCE:

 [View CGS74C2525MX](#) on WIN SOURCE

 [Texas Instruments](#) Information

## Optimize Your Supply Chain with WIN SOURCE Solutions

-  Global Sourcing Solution
-  Obsolete Management
-  Cost Control Management
-  Shortage Management
-  Alternative Solution
-  Excess Inventory Management