



**THE DATASHEET OF  
CGS3322M**



## CGS3321 • CGS3322 CMOS Crystal Clock Generators

### General Description

The CGS3321 and CGS3322 devices are designed for Clock Generation and Support (CGS) applications up to 110 MHz. The CGS332x series of devices are crystal controlled CMOS oscillators requiring a minimum of external components. The 332x devices provide selectable output divide ratio. The circuit is designed to operate over a wide frequency range using fundamental mode or overtone crystals.

### Features

- Fairchild's CGS family of devices for high frequency clock source applications
- Crystal frequency operation range:  
fundamental: 10 MHz to 100 MHz typical  
3rd or 5th overtone: 10 MHz to 95 MHz
- 1000V ESD protection on OCS\_IN and OSC\_OUT pins.  
2000V ESD protection on all other pins
- Output current drive of 48 mA for  $I_{OL}/I_{OH}$
- FACT™ CMOS output levels
- Output has high speed short circuit protection
- Intended for Pierce oscillator applications
- Hysteresis inputs to improve noise margin
- CGS3321 has duty cycle adjust
- CGS3322 has 1, 2, 4 divide ratio

### Ordering Code:

Order Number	Package Number	Package Description
CGS3321M	M08A	8-Lead Small Outline Integrated Circuit (SOIC), JEDEC MS-012, 0.150" Narrow
CGS3322M	M08A	8-Lead Small Outline Integrated Circuit (SOIC), JEDEC MS-012, 0.150" Narrow

Devices also available in Tape and Reel. Specify by appending the suffix letter "X" to the ordering code.

### Connection Diagrams

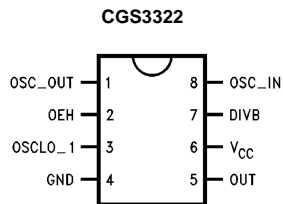
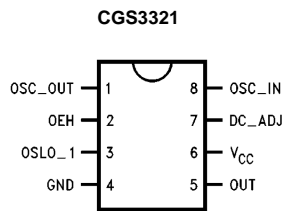

### Truth Table

Division Selection

DIVB	OEH	Divider Output
F	X	Divide-by 1
1	1	Divide-by 2
0	1	Divide-by 4

Note: Actual value of the floating DIVB input is  $V_{CC}/2$

FACT™ is a trademark of Fairchild Semiconductor Corporation.

## Pin Descriptions

**Note:** Pin out varies for each device.

OSC_IN	Input to Oscillator Inverter. The output of the crystal would be connected here.	OEH	Active HIGH 3-STATE enable pin. This pin pulls to a HIGH value when left floating and 3-STATEs the output when forced LOW. This pin has TTL compatible input levels.
OSC_OUT	Resistive Buffered Output of the Oscillator Inverter	OUT	This pin is the main clock output on the device.
DIVB	(CGS3321 only) 3-Level input used to select Binary Divide-by value of output frequency.	OSCLO_1	The Oscillator LOW pin is the ground for the Oscillator.
DC_ADJ	(CGS3321 only) Active high input that controls output duty cycle. Logic high level will delay the HL transition edge approximately 0.3 ns.	V <sub>CC</sub>	The power pin for the chip.
		GND	The ground pin for all sections of the circuitry except the oscillator and oscillator related circuitry.

**Note:** Pin out varies for each device.

## Block Diagrams

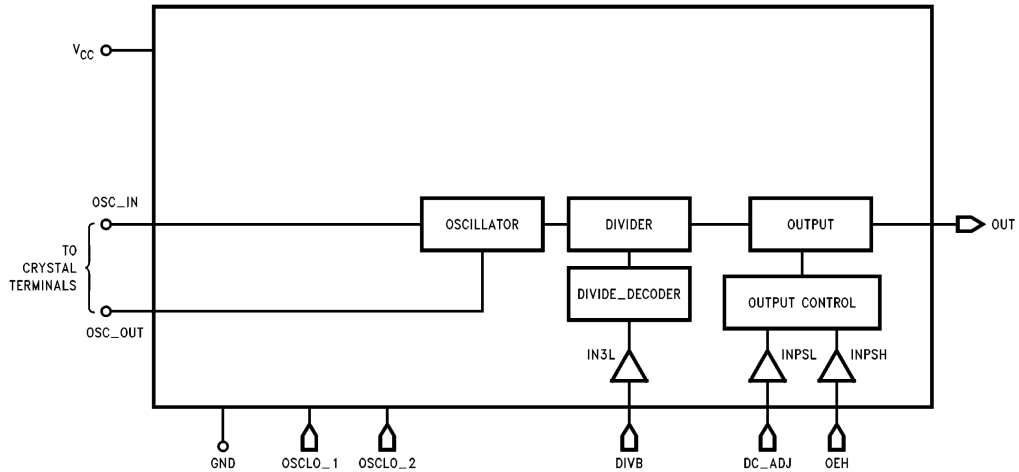

**Note:** Pin numbers vary for each device

**Block Diagrams** (Continued)

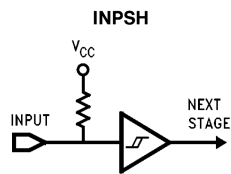

**Oscillator Stage**

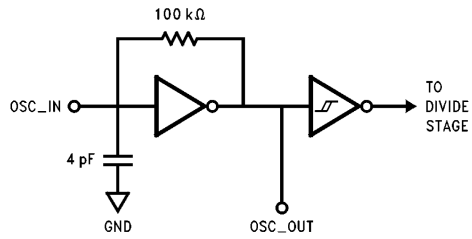

**Output Stage**

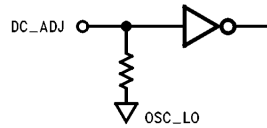
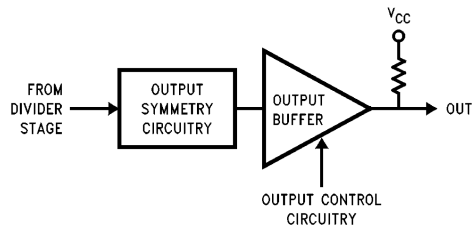

**Absolute Maximum Ratings**(Note 1)

Supply Voltage ( $V_{CC}$ )	-0.5V to 7.0V
DC Input Voltage Diode Current ( $I_{IK}$ )	$\pm 9$ mA
DC Input Voltage ( $V_I$ )	-0.5V to 7.0V
DC Output Diode Current ( $I_{OK}$ )	$\pm 20$ mA
DC Output Voltage ( $V_O$ )	-0.5V to $V_{CC} + 0.5V$
DC Output Source or Sink Current ( $I_O$ )	$\pm 70$ mA
Storage Temperature ( $T_{STG}$ )	-55°C to 150°C
Junction Temperature ( $T_J$ ) SOIC	140°C/W

**Recommended Operating Conditions**

Supply Voltage ( $V_{CC}$ )	4.5V to 5.5V
Input Voltage ( $V_I$ )	0V to 5.5V
Output Voltage ( $V_O$ )	0V to $V_{CC}$ V
Operating Temperature ( $T_A$ )	-40° to +85°C

**Note 1:** The Absolute Maximum Ratings are those values beyond which the safety of the device cannot be guaranteed. The device should not be operated at these limits. The parametric values defined in the DC and AC Electrical Characteristics tables are not guaranteed at the absolute maximum ratings. The Recommended Operating Conditions will define the conditions for actual device operation.

**DC Electrical Characteristics**

Symbol	Parameter	$V_{CC}$ (V)	$T_A = +25^\circ\text{C}$				$T_A = -40^\circ\text{C to } +85^\circ\text{C}$		Units	Conditions
			Typ	Guaranteed Limits		Min	Max			
				Min	Max					
$V_{IH\text{TTL}}$	Minimum HIGH Level Input Voltage, TTL Level Inputs (OEH, OEL)	4.5		2.0		2.0		V		
		5.5		2.0		2.0				
$V_{IL\text{TTL}}$	Maximum LOW Level Input Voltage, TTL Level Inputs (OEH, OEL)	4.5			0.8		0.8	V		
		5.5			0.8		0.8			
$V_{IH\text{CMOS}}$	Minimum HIGH Level Input Voltage, CMOS Level Inputs (DC_ADJ)	4.5		3.15		3.15		V		
		5.5		3.85		3.85				
$V_{IL\text{CMOS}}$	Maximum LOW Level Input voltage, CMOS Level Inputs (DC_ADJ)	4.5			1.35		1.35	V		
		5.5			1.65		1.65			
$V_{IN3\_L\_H}$	Minimum Logic 1 Input for Three Level Input (DIVB)	4.5		4.05		4.05		V		
		5.5		4.95		4.95				
$V_{IN3\_L\_1/2}$	Minimum Logic 1/2 Input for Three Level Input (DIVB)	4.5		1.8	2.7	1.8	2.7	V		
		5.5		2.2	3.3	2.2	3.3			
$V_{IN3\_L\_L}$	Maximum Logic 0 Input Level Three Level Input (DIVB)	4.5			0.45		0.45	V		
		5.5			0.45		0.45			
$V_{OH}$	Minimum HIGH Level Output Voltage	4.5	4.49	4.40		4.40		V	$I_{OUT} = -50\mu\text{A}$	
		5.5	5.49	5.40		5.40				
		4.5		3.86		3.76				
		5.5		4.86		4.76				
$V_{OL}$	Minimum LOW Level Output Voltage	4.5	0.001		0.1		0.1	V	$I_{OUT} = 50\mu\text{A}$	
		5.5	0.001		0.1		0.1			
		4.5			0.44		0.44			
		5.5			0.44		0.44			
$I_{IH\text{RES}}$	Input Current for Pins DIVB	5.5		220	360	200	380	$\mu\text{A}$	$V_{IN} = 5.5V$	
$I_{IL\text{RES}}$	Input Current for Pins DIVB	5.5		-220	-360	-200	-380	$\mu\text{A}$	$V_{IN} = 0.0V$	
$I_{IH\text{ENAB}}$	Input Current for Enable Pin OEL	5.5		90	160	85	175	$\mu\text{A}$	$V_{IN} = 5.5V$	
$I_{IL\text{ENAB}}$	Input Current for Enable Pin OEH	5.5		-90	-160	-85	-175	$\mu\text{A}$	$V_{IN} = 0.0V$	
$I_{IH\text{OSC}}$	Input Current for OSC_IN Pin (Indicates Bias Resistance)	5.5		20	100	20	125	$\mu\text{A}$	$V_{IN} = 5.5V$	
$I_{IL\text{OSC}}$	Input Current for OSC_IN Pin (Indicates Bias Resistance)	5.5		-20	-100	-20	-125	$\mu\text{A}$	$V_{IN} = 0.0V$	
$I_{OZH}$	Output Disabled Current (Output HIGH)	4.5			3.0		5.0	$\mu\text{A}$	$V_{OUT} = V_{CC}$	
		5.5			3.0		5.0			
$I_{OZL}$	Output Disabled Current (Output LOW)	4.5			-140		-150	$\mu\text{A}$	$V_{OUT} = 0.0V$	
		5.5			-170		-180			

**DC Electrical Characteristics** (Continued)

Symbol	Parameter	V <sub>CC</sub> (V)	T <sub>A</sub> = +25°C		T <sub>A</sub> = -40°C to +85°C		Units	Conditions	
			Typ	Guaranteed Limits					
				Min	Max	Min			Max
I <sub>OLD</sub>	Minimum Dynamic Output Current	5.5		75		75		mA	V <sub>OLD</sub> = 1.65V
I <sub>OHD</sub>	Minimum Dynamic Output Current	5.5		-75		-75		mA	V <sub>OHD</sub> = 3.85V
I <sub>CC2</sub>	Additional Maximum I <sub>CC</sub> per Input (OE <sub>H</sub> , OEL Pins)	5.5			1.5		1.5	mA	V <sub>IN</sub> = V <sub>CC</sub> - 2.1V
I <sub>CC3L</sub>	Additional Maximum I <sub>CC</sub> per Input (DIVB)	5.5			1.5		1.5	mA	DIVB, OSC_DR Inputs Equal to V <sub>CC/2</sub>

**AC Electrical Characteristics**

Over recommended operating free air temperature range. All typical values are measured at V<sub>CC</sub> = 5V, T<sub>A</sub> = 25°C.

Symbol	Parameter	V <sub>CC</sub> (V) (Note 2)	T <sub>A</sub> = -40°C to +85°C			Units
			C <sub>L</sub> = 50 pF			
			Min	Type	Max	
f <sub>MAX</sub>	Frequency Maximum	5.0	95	110		MHz
t <sub>pZH</sub>	Output HIGH Enable Time	5.0	1.0		31.5	ns
t <sub>pZL</sub>	Output LOW Enable Time	5.0	1.0		28.0	ns
t <sub>pHZ</sub>	Output HIGH Disable Time	5.0	1.0		21.5	ns
t <sub>pLZ</sub>	Output LOW Disable Time	5.0	1.0		16.0	ns
t <sub>RISE</sub>	Rise/Fall Time	5.0		1.0		ns
t <sub>FALL</sub>	30 pF (20% to 80%)					

**Note 2:** Voltage Range 5.0 is 5.0V ± 0.5V

**Physical Dimensions** inches (millimeters) unless otherwise noted

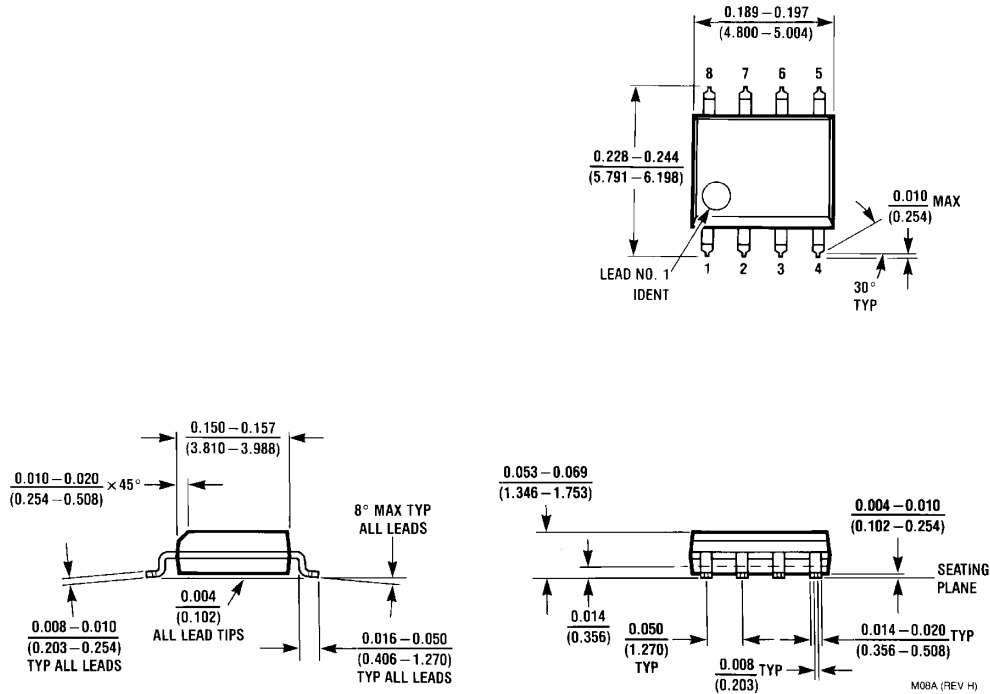

8-Lead Small Outline Integrated Circuit (SOIC), JEDEC MS-012, 0.150" Narrow Package Number M08A

Fairchild does not assume any responsibility for use of any circuitry described, no circuit patent licenses are implied and Fairchild reserves the right at any time without notice to change said circuitry and specifications.

**LIFE SUPPORT POLICY**

FAIRCHILD'S PRODUCTS ARE NOT AUTHORIZED FOR USE AS CRITICAL COMPONENTS IN LIFE SUPPORT DEVICES OR SYSTEMS WITHOUT THE EXPRESS WRITTEN APPROVAL OF THE PRESIDENT OF FAIRCHILD SEMICONDUCTOR CORPORATION. As used herein:

1. Life support devices or systems are devices or systems which, (a) are intended for surgical implant into the body, or (b) support or sustain life, and (c) whose failure to perform when properly used in accordance with instructions for use provided in the labeling, can be reasonably expected to result in a significant injury to the user.
2. A critical component in any component of a life support device or system whose failure to perform can be reasonably expected to cause the failure of the life support device or system, or to affect its safety or effectiveness.

[www.fairchildsemi.com](http://www.fairchildsemi.com)

## Looking for pricing, stock, or lifecycle information?

Click below to explore more details on WIN SOURCE:

- ⊖ [View CGS3322M on WIN SOURCE](#)
- ⊖ [Fairchild/ON Semiconductor Information](#)

## Optimize Your Supply Chain with WIN SOURCE Solutions

- ✓ Global Sourcing Solution
- ✓ Obsolete Management
- ✓ Cost Control Management
- ✓ Shortage Management
- ✓ Alternative Solution
- ✓ Excess Inventory Management