



**THE DATASHEET OF  
CGS3312M**



**CGS3311 • CGS3312 • CGS3313 • CGS3314 • CGS3315 •  
CGS3316 • CGS3317 • CGS3318 • CGS3319  
CMOS Crystal Clock Generators**

**General Description**

The CGS3311, CGS3312, CGS3313, CGS3314, CGS3315, CGS3316, CGS3317, CGS3318 and CGS3319 devices are designed for Clock Generation and Support (CGS) applications up to 110 MHz. The CGS331x series of devices are crystal controlled CMOS oscillators requiring a minimum of external components. The 331x devices provide selectable output divide ratio (and selectable crystal drive level). The circuit is designed to operate over a wide frequency range using fundamental mode or overtone crystals.

**Features**

- Fairchild's CGS family of devices for high frequency clock source applications
- Crystal frequency operation range:  
fundamental: 10 MHz to 100 MHz typical  
3rd or 5th overtone: 10 MHz to 85 MHz
- Programmable oscillator drive
- Selectable fast output edge rates
- Output symmetry circuit to adjust 50% duty cycle point between CMOS and TTL levels
- Output current drive of 48 mA for  $I_{OL}/I_{OH}$
- FACT™ CMOS output levels
- Output has high speed short circuit protection
- Basic oscillator type: Pierce
- Hysteresis inputs to improve noise margin

**Ordering Code:**

Order Number	Package Number	Package Description
CGS3311M	M08A	8-Lead Small Outline Integrated Circuit (SOIC), JEDEC MS-012, 0.150" Narrow Body
CGS3312M	M08A	8-Lead Small Outline Integrated Circuit (SOIC), JEDEC MS-012, 0.150" Narrow Body
CGS3313M	M08A	8-Lead Small Outline Integrated Circuit (SOIC), JEDEC MS-012, 0.150" Narrow Body
CGS3314M	M08A	8-Lead Small Outline Integrated Circuit (SOIC), JEDEC MS-012, 0.150" Narrow Body
CGS3315M	M08A	8-Lead Small Outline Integrated Circuit (SOIC), JEDEC MS-012, 0.150" Narrow Body
CGS3316M	M08A	8-Lead Small Outline Integrated Circuit (SOIC), JEDEC MS-012, 0.150" Narrow Body
CGS3317M	M08A	8-Lead Small Outline Integrated Circuit (SOIC), JEDEC MS-012, 0.150" Narrow Body
CGS3318M	M08A	8-Lead Small Outline Integrated Circuit (SOIC), JEDEC MS-012, 0.150" Narrow Body
CGS3319M	M08A	8-Lead Small Outline Integrated Circuit (SOIC), JEDEC MS-012, 0.150" Narrow Body

Devices also available in Tape and Reel. Specify by appending the suffix letter "X" to the ordering code.

FACT™ is a trademark of Fairchild Semiconductor Corporation.

CGS3311 • CGS3312 • CGS3313 • CGS3314 • CGS3315 • CGS3316 • CGS3317 • CGS3318 • CGS3319 CMOS Crystal Clock Generators

### Connection Diagrams

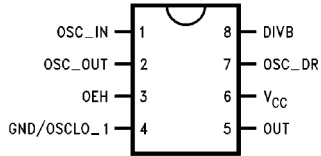

(A) 3311

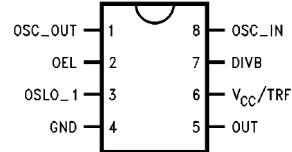

(E) 3315

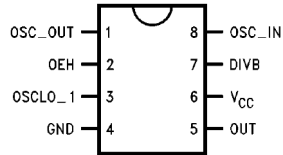

(B) 3312

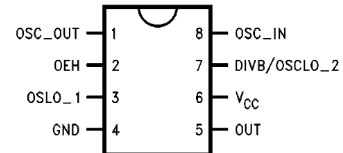

(F) 3316

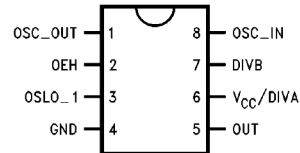

(C) 3313

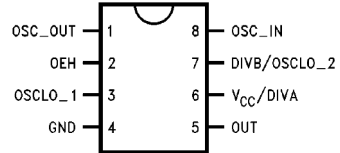

(G) 3317

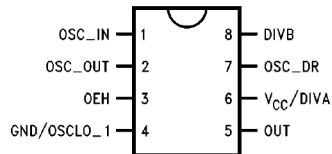

(D) 3314

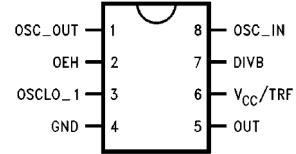

(H) 3318

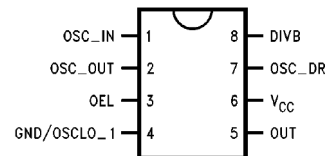

(I) 3319

## Truth Tables

**Division Selection**

DIVB	DIVA	OEL	OEH	Divider Output
F	0/F	X	X	Divide-by 1
1	0/F	0	1	Divide-by 2
0	0/F	0	1	Divide-by 4
F	1	0	1	Divide-by 8
1	1	0	1	Divide-by 16
0	1	0	1	Divide-by 32
X	X	1	X	Output Reset HIGH at Re-enable
X	X	X	0	Output Reset HIGH at Re-enable

Note: Actual value of the floating OSC\_DR and DIVB input is V<sub>CC/2</sub>

**Rise and Fall Time Selection**

OSC_DR	DIV	TRF	Rise/Fall Time (ns)
F	N	0/F	2
F	N	1	less than 2
F	Y	0/F	4
F	Y	1	2
0,1	X	0/F	4
0,1	X	1	2

**Drive Selection**

OSC_DR	Drive
0	Low
1	Medium
F	High

Note: Where "F" indicates floating the input.

## Pin Descriptions

Note: Pin out varies for each device.

OSC_IN	Input to Oscillator Inverter. The output of the crystal would be connected here.	OEL	Active LOW 3-STATE enable pin. This pin pulls to a low value when left floating and 3-STATE the output when forced HIGH. This pin has TTL compatible input levels.
OSC_OUT	Resistive Buffered Output of the Oscillator Inverter	TRF	Rise and Fall time override pin. Available only for die form.
OSC_DR	3 Level input pin that selects Oscillator Drive Level	OUT	This pin is the main clock output on the device.
DIVA	Input used to select Binary Divide-by Option. This pin has CMOS compatible input levels.	OSCLO_1	The Oscillator LOW pin is the ground for the Oscillator.
OEH	Active HIGH 3-STATE enable pin. This pin pulls to a high value when left floating and 3-STATES the output when forced low. This pin has TTL compatible input levels.	OSCLO_2	This pin is the same signal as OSCLO_1. It has been provided as an alternate connection for OSCLO_1 for hybrid assemblies.
		V <sub>CC</sub>	The power pin for the chip.
		GND	The ground pin for all sections of the circuitry except the oscillator and oscillator related circuitry.

## Functional Table

**Summary of Device Options**

Device	Divide	Enable	Drive	Output Rise/Fall Time (ns)
3311	1, 2, 4	OEH	L, M, H	2, 4
3312	1, 2, 4	OEH	H	2, 4
3313	8, 16, 32	OEH	H	4
3314	8, 16, 32	OEH	L, M, H	4
3315	1, 2, 4	OEL	H	1, 2
3316	4	OEH	H	4
3317	32	OEH	H	4
3318	1, 2, 4	OEH	H	1, 2
3319	1, 2, 4	OEL	L, M, H	2, 4

Each drive has one output with the choices of selecting frequency divide, output enable, crystal drive and output rise and fall time. Crystal drive options are:  
 L = LOW Drive  
 M = MEDIUM Drive  
 H = HIGH Drive

### Block Diagrams

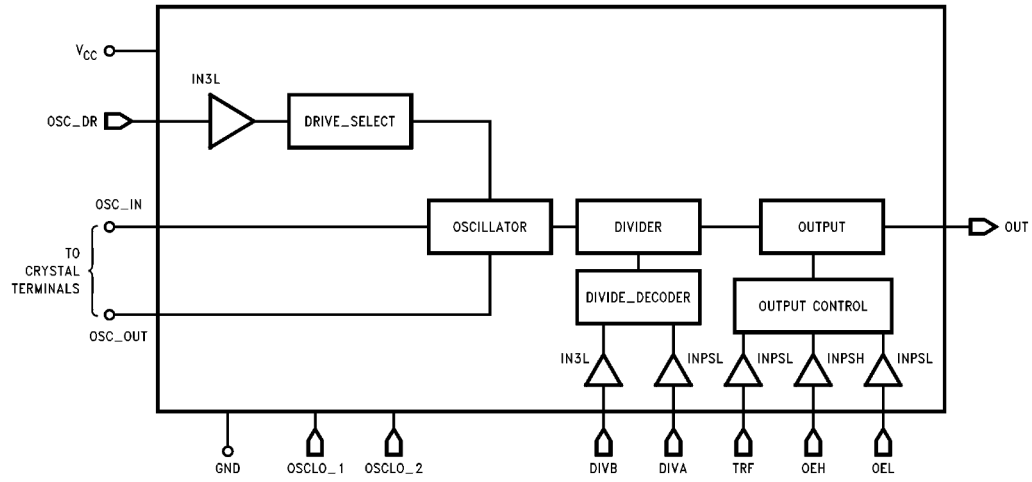

Note: Pin numbers vary for each device

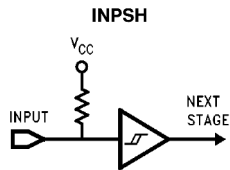
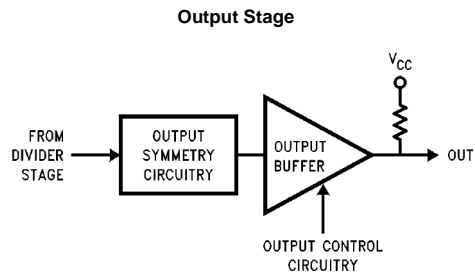
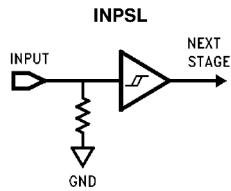
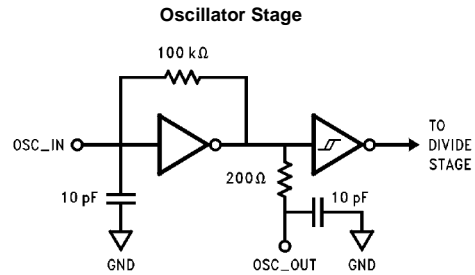
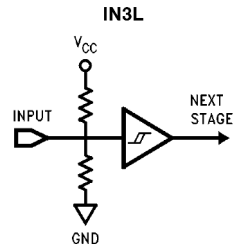

### Absolute Maximum Ratings (Note 1)

Supply Voltage ( $V_{CC}$ )	-0.5V to 7.0V
DC Input Voltage Diode Current ( $I_{IK}$ )	±9 mA
DC Input Voltage ( $V_I$ )	-0.5V to 7.0V
DC Output Diode Current ( $I_{OK}$ )	±20 mA
DC Output Voltage ( $V_O$ )	-0.5V to $V_{CC} + 0.5V$
DC Output Source or Sink Current ( $I_O$ )	±70 mA
Storage Temperature ( $T_{STG}$ )	-55°C to 150°C
Junction Temperature ( $T_J$ )	
SOIC	140°C/W

### Recommended Operating Conditions

Supply Voltage ( $V_{CC}$ )	4.5V to 5.5V
Input Voltage ( $V_I$ )	0V to 5.5V
Output Voltage ( $V_O$ )	0V to $V_{CC}$ V
Operating Temperature ( $T_A$ )	-40° to +85°C

**Note 1:** The Absolute Maximum Ratings are those values beyond which the safety of the device cannot be guaranteed. The device should not be operated at these limits. The parametric values defined in the DC and AC Electrical Characteristics tables are not guaranteed at the absolute maximum ratings. The Recommended Operating Conditions will define the conditions for actual device operation.

### DC Electrical Characteristics

Symbol	Parameter	$V_{CC}$ (V)	$T_A = +25^\circ\text{C}$		$T_A = -40^\circ\text{C to } +85^\circ\text{C}$		Units	Conditions	
			Typ	Guaranteed Limits		Min			Max
				Min	Max				
$V_{IH\text{TTL}}$	Minimum HIGH Level Input Voltage, TTL Level Inputs (OEH, OEL)	4.5		2.0		2.0		V	
		5.5		2.0		2.0			
$V_{IL\text{TTL}}$	Maximum LOW Level Input Voltage, TTL Level Inputs (OEH, OEL)	4.5			0.8		0.8	V	
		5.5			0.8		0.8		
$V_{IH\text{CMOS}}$	Minimum HIGH Level Input Voltage, CMOS Level Inputs (DIVA)	4.5		3.15		3.15		V	
		5.5		3.85		3.85			
$V_{IL\text{CMOS}}$	Maximum LOW Level Input voltage, CMOS Level Inputs (DIVA)	4.5		1.35		1.35		V	
		5.5		1.65		1.65			
$V_{IN3\_H}$	Minimum Logic 1 Input for Three Level Input (DIVB, OSC_DR)	4.5		4.05		4.05		V	
		5.5		4.95		4.95			
$V_{IN3\_1/2}$	Minimum Logic 1/2 Input for Three Level Input (DIVB, OSC_DR)	4.5		1.8	2.7	1.8	2.7	V	
		5.5		2.2	3.3	2.2	3.3		
$V_{IN3\_L}$	Maximum Logic 0 Input Level Three Level Input (DIVB, OSC_DR)	4.5			0.45		0.45	V	
		5.5			0.45		0.45		
$V_{OH}$	Minimum HIGH Level Output Voltage	4.5	4.49	4.40		4.40		V	
		5.5	5.49	5.40		5.40			
		4.5		3.86		3.76			
		5.5		4.86		4.76			
$V_{OL}$	Minimum LOW Level Output Voltage	4.5	0.001		0.1		0.1	V	
		5.5	0.001		0.1		0.1		
		4.5			0.44		0.44		
		5.5			0.44		0.44		
$I_{IH\text{RES}}$	Input Current for Pins DIVB, OSC_DR, and DIVA (Input is Logic HIGH)	5.5		220	360	200	380	μA	$V_{IN} = 5.5V$
$I_{IL\text{RES}}$	Input Current for Pins DIVB, OSC_DR, and DIVA (Input is Logic LOW)	5.5		-220	-360	-200	-380	μA	$V_{IN} = 0.0V$
$I_{IH\text{ENAB}}$	Input Current for Enable Pin OEL	5.5		90	160	85	175	μA	$V_{IN} = 5.5V$
$I_{ILE\text{NAB}}$	Input Current for Enable Pin OEH	5.5		-90	-160	-85	-175	μA	$V_{IN} = 0.0V$
$I_{IH\text{OSC}}$	Input Current for OSC_IN Pin (Indicates Bias Resistance)	5.5		20	100	20	125	μA	$V_{IN} = 5.5V$
$I_{ILO\text{OSC}}$	Input Current for OSC_IN Pin (Indicates Bias Resistance)	5.5		-20	-100	-20	-125	μA	$V_{IN} = 0.0V$
$I_{OZH}$	Output Disabled Current (Output HIGH)	4.5			3.0		5.0	μA	$V_{OUT} = V_{CC}$
		5.5			3.0		5.0		

DC Electrical Characteristics (Continued)									
Symbol	Parameter	V <sub>CC</sub> (V)	T <sub>A</sub> = +25°C		T <sub>A</sub> = -40°C to +85°C		Units	Conditions	
			Typ	Guaranteed Limits					
				Min	Max	Min			Max
I <sub>OZL</sub>	Output Disabled Current (Output LOW)	4.5 5.5			-140 -170		-150 -180	µA	V <sub>OUT</sub> = 0.0V
I <sub>OLD</sub>	Minimum Dynamic Output Current	5.5	75		75			mA	V <sub>OLD</sub> = 1.65V
I <sub>OHD</sub>	Minimum Dynamic Output Current	5.5	-75		-75			mA	V <sub>OHD</sub> = 3.85V
I <sub>CCOSC_L</sub>	Additional I <sub>CC</sub> with OSC_IN Floating, LOW Drive Mode	4.5 5.5		0.6		0.6		mA	OSC_IN = Float
I <sub>CCOSC_M</sub>	Additional I <sub>CC</sub> with OSC_IN Floating, LOW Drive Mode	4.5 5.5		1.7		1.7	6.5 12.4	mA	OSC_IN = Float
I <sub>CCOSC_H</sub>	Additional I <sub>CC</sub> with OSC_IN Floating, LOW Drive Mode	4.5 5.5		5.5		5.5	31.5 31.5	mA	OSC_IN = Float
I <sub>CC1</sub>	Additional Maximum I <sub>CC</sub> per Input (OEH, OEL Pins)	5.5			1.5		1.5	mA	V <sub>IN</sub> = V <sub>CC</sub> - 2.1V
I <sub>CC3L</sub>	Additional Maximum I <sub>CC</sub> per Input (DIVB, OSC_DR Inputs)	5.5			1.5		1.5	mA	DIVB, OSC_DR Inputs Equal to V <sub>CC/2</sub>

AC Electrical Characteristics						
Over recommended operating free air temperature range. All typical values are measured at V <sub>CC</sub> = 5V, T <sub>A</sub> = 25°C.						
Symbol	Parameter	V <sub>CC</sub> (V) (Note 2)	T <sub>A</sub> = -40°C to +85°C C <sub>L</sub> = 50 pF			Units
			Min	Type	Max	
f <sub>MAX</sub>	Frequency Maximum	5.0	100			ns
t <sub>PZH</sub>	Output HIGH Enable Time	5.0	1.0		31.5	ns
t <sub>PZL</sub>	Output LOW Enable Time	5.0	1.0		28.0	ns
t <sub>PHZ</sub>	Output HIGH Disable Time	5.0	1.0		21.5	ns
t <sub>PLZ</sub>	Output LOW Disable Time	5.0	1.0		16.0	ns
t <sub>RISE</sub>	Rise/Fall Time	5.0		4.0		ns
t <sub>FALL</sub>	30 pF (20% to 80%)					

**Note 2:** Voltage Range 5.0 is 5.0V ± 0.5V

**Physical Dimensions** inches (millimeters) unless otherwise noted

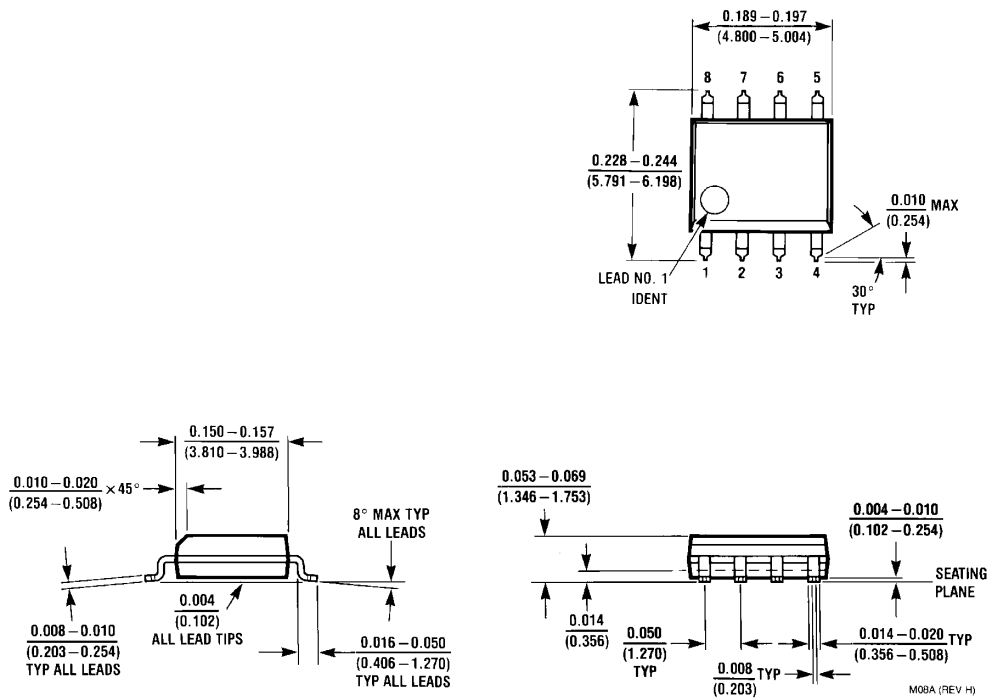

**8-Lead Small Outline Integrated Circuit (SOIC), JEDEC MS-012, 0.150" Narrow Body  
 Package Number M08A**

**LIFE SUPPORT POLICY**



FAIRCHILD'S PRODUCTS ARE NOT AUTHORIZED FOR USE AS CRITICAL COMPONENTS IN LIFE SUPPORT DEVICES OR SYSTEMS WITHOUT THE EXPRESS WRITTEN APPROVAL OF THE PRESIDENT OF FAIRCHILD SEMICONDUCTOR CORPORATION. As used herein:

1. Life support devices or systems are devices or systems which, (a) are intended for surgical implant into the body, or (b) support or sustain life, and (c) whose failure to perform when properly used in accordance with instructions for use provided in the labeling, can be reasonably expected to result in a significant injury to the user.
2. A critical component in any component of a life support device or system whose failure to perform can be reasonably expected to cause the failure of the life support device or system, or to affect its safety or effectiveness.

[www.fairchildsemi.com](http://www.fairchildsemi.com)

## Looking for pricing, stock, or lifecycle information?

Click below to explore more details on WIN SOURCE:

-  [View CGS3312M on WIN SOURCE](#)
-  [Fairchild/ON Semiconductor Information](#)

## Optimize Your Supply Chain with WIN SOURCE Solutions

-  Global Sourcing Solution
-  Obsolete Management
-  Cost Control Management
-  Shortage Management
-  Alternative Solution
-  Excess Inventory Management