



**THE DATASHEET OF
CFR50J10K**



LOC	DIST	REVISIONS			
P	LTR	DESCRIPTION	DATE	DWN	APVD
E	B	BA1	REVISED PER ECO-11-005150	29MAR2011	RK HMR

FOR FURTHER INFORMATION SEE DATA SHEET FOR
CFR SERIES-CARBON FILM FIXED RESISTORS

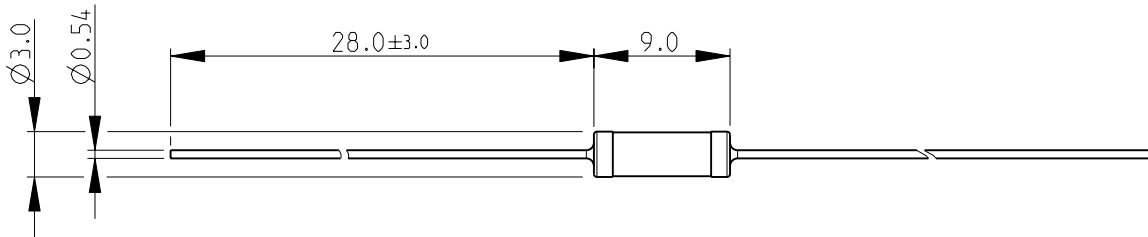

RoHS Compliant

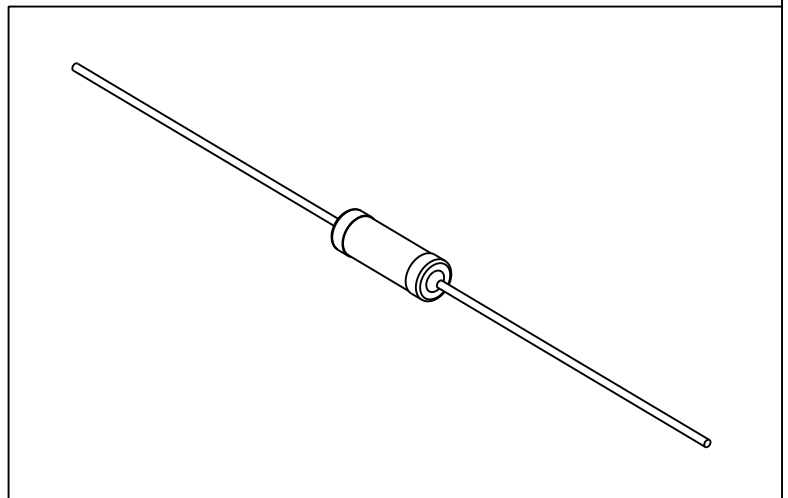

2008

RELEASED FOR PUBLICATION

ALL RIGHTS RESERVED.



THIS DRAWING IS UNPUBLISHED.

BY -
© COPYRIGHT 2008



DIMENSIONS: mm	DWN	20-Sep-08	MATERIAL	-	FINISH	-					
	SUBHASH.M										
TOLERANCES UNLESS OTHERWISE SPECIFIED:	CHK	20-Sep-08	 TE Connectivity								
	PRAKASH.S										
0 PLC ±0.2 1 PLC ±0.1 2 PLC ± 3 PLC ± 4 PLC ± ANGLES ±5°	APVD	20-Sep-08	NAME CARBON FILM FIXED RESISTORS SERIES CFR50								
	STEPHEN.P										
	PRODUCT SPEC	-	SIZE	CAGE CODE	DRAWING NO	RESTRICTED TO					
	APPLICATION SPEC	-	A 4	00779	©- 1623932	-					
	WEIGHT	-	CUSTOMER DRAWING			SCALE	2:1	SHEET	1 OF 1	REV	BA1

Looking for pricing, stock, or lifecycle information?

Click below to explore more details on WIN SOURCE:

-  [View CFR50J10K on WIN SOURCE](#)
-  [TE Connectivity Information](#)

Optimize Your Supply Chain with WIN SOURCE Solutions

-  Global Sourcing Solution
-  Obsolete Management
-  Cost Control Management
-  Shortage Management
-  Alternative Solution
-  Excess Inventory Management