



# THE DATASHEET OF TSH300IDT



## Ultra Low-Noise High-Speed Operational Amplifier

- Structure: VFA
- 200 MHz bandwidth
- Input noise: 0.65 nV/√Hz
- Stable for gains > 5
- Slew rate: 230 V/μs
- Specified on 100Ω load
- Tested on 5 V power supply
- Single or dual supply operation
- Minimum and maximum limits are tested in full production

### Description

The TSH300 is a voltage feedback amplifier featuring ultra-low input voltage and current noise. This feature, associated with a large bandwidth, large slew rate and a good linearity, makes the TSH300 a good choice for high-speed data acquisition systems where sensitivity and signal integrity are the main priorities.

The TSH300 is a single operator available in SO8 and the tiny SOT23-5L plastic package, saving board space as well as providing excellent thermal performances.

### Applications

- High speed data acquisition systems
- Probe equipment
- Communication & video test equipment
- Medical instrumentation
- ADC drivers

### Pin Connections (top view)

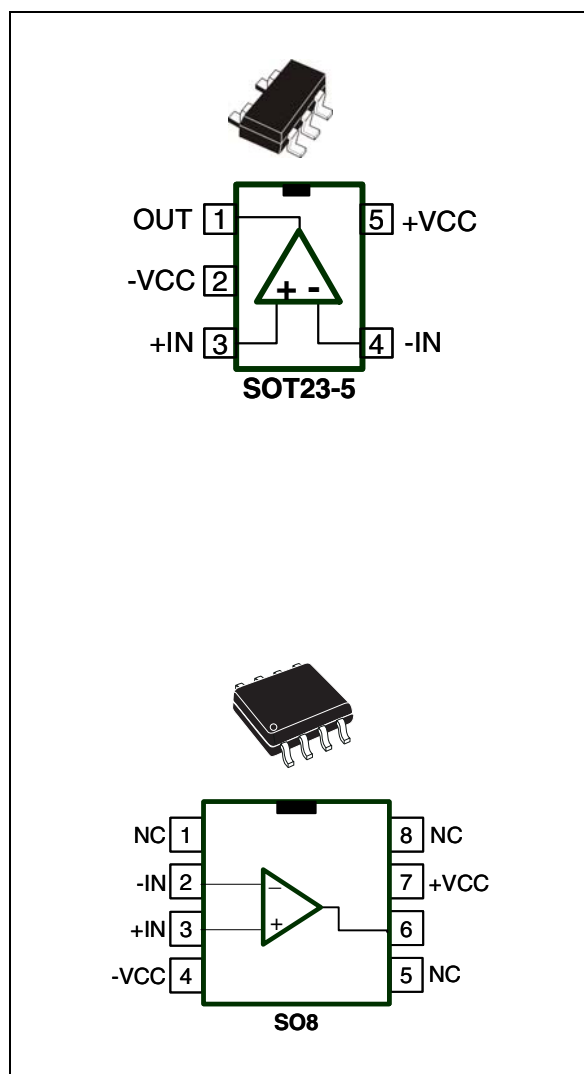

### Order Codes

Part Number	Temperature Range	Package	Packing	Marking
TSH300ILT	-40°C to +85°C	SOT23-5L	Tape & Reel	K308
TSH300ID		SO-8	Tube	TSH300I
TSH300IDT		SO-8	Tape & Reel	TSH300I

# 1 Absolute Maximum Ratings

**Table 1. Key parameters and their absolute maximum ratings**

Symbol	Parameter	Value	Unit
V <sub>CC</sub>	Supply Voltage <sup>(1)</sup>	6	V
V <sub>id</sub>	Differential Input Voltage <sup>(2)</sup>	+/-0.5	V
V <sub>in</sub>	Input Voltage Range <sup>(3)</sup>	+/-2.5	V
T <sub>oper</sub>	Operating Free Air Temperature Range	-40 to +85	°C
T <sub>stg</sub>	Storage Temperature	-65 to +150	°C
T <sub>j</sub>	Maximum Junction Temperature	150	°C
R <sub>thja</sub>	Thermal Resistance Junction to Ambient SOT23-5L SO8	250	°C/W
		150	
R <sub>thjc</sub>	Thermal Resistance Junction to Case SOT23-5L SO8	80	°C/W
		28	
P <sub>max</sub>	Maximum Power Dissipation <sup>(4)</sup> (@ Ta=25°C) for Tj=150°C SOT23-5L SO8	500	mW
		830	
ESD	HBM: Human Body Model <sup>(5)</sup> (all packages)	1	kV
	MM: Machine Model <sup>(6)</sup> (all packages)	150	V
	CDM: Charged Device Model (SO8)	1.5	kV
	Latch-up Immunity	200	mA

1. All voltage values are measured with respect to the ground pin.
2. Differential voltage is between the non-inverting input terminal and the inverting input terminal.
3. The magnitude of input and output voltage must never exceed V<sub>CC</sub> +0.3V.
4. Short-circuits can cause excessive heating. Destructive dissipation can result from short circuits on amplifiers.
5. Human body model, 100pF discharged through a 1.5kΩ resistor into P<sub>min</sub> of device.
6. This is a minimum value. Machine model ESD, a 200pF cap is charged to the specified voltage, then discharged directly into the IC with no external series resistor (internal resistor < 5Ω), into pin to pin of device.

**Table 2. Operating conditions**

Symbol	Parameter	Value	Unit
V <sub>CC</sub>	Supply Voltage <sup>(1)</sup>	4.5 to 5.5	V
V <sub>icm</sub>	Common Mode Input Voltage	-1.5 to +1.6	V

1. Tested in full production at 5V (±2.5V) supply voltage.

## 2 Electrical Characteristics

Table 3. Electrical characteristics for  $V_{CC} = \pm 2.5V$ ,  $T_{amb} = 25^{\circ}C$  (unless otherwise specified)

Symbol	Parameter	Test Condition	Min.	Typ.	Max.	Unit	
<b>DC performance</b>							
$V_{io}$	<b>Input Offset Voltage</b> Offset Voltage between both inputs	$T_{amb}$	-1.8	0.5	1.8	mV	
		$T_{min.} < T_{amb} < T_{max.}$		0.5			
$\Delta V_{io}$	$V_{io}$ drift vs. Temperature	$T_{min.} < T_{amb} < T_{max.}$		-3.8		$\mu V/^{\circ}C$	
$I_{ib+}$	<b>Non Inverting Input Bias Current</b> DC current necessary to bias the input +	$T_{amb}$		30	46	$\mu A$	
		$T_{min.} < T_{amb} < T_{max.}$		33			
$I_{ib-}$	<b>Inverting Input Bias Current</b> DC current necessary to bias the input -	$T_{amb}$	-46	-30		$\mu A$	
		$T_{min.} < T_{amb} < T_{max.}$		-34			
CMR	<b>Common Mode Rejection Ratio</b> $20 \log (\Delta V_{ic}/\Delta V_{io})$	$\Delta V_{ic} = \pm 1V$	60	88		dB	
		$T_{min.} < T_{amb} < T_{max.}$		83			
SVR	<b>Supply Voltage Rejection Ratio</b> $20 \log (\Delta V_{cc}/\Delta V_{io})$	$\Delta V_{cc} = 3.5V \text{ to } 5V$	70	77		dB	
		$T_{min.} < T_{amb} < T_{max.}$		74			
PSRR	<b>Power Supply Rejection Ratio</b> $20 \log (\Delta V_{cc}/\Delta V_{out})$	Gain = +5, $\Delta V_{cc} = \pm 100mV$ at 1kHz		76		dB	
$I_{cc}$	<b>Positive Supply Current</b> DC consumption with no input signal	No load		15	19.5	mA	
		$T_{min.} < T_{amb} < T_{max.}$		15.3			
<b>Dynamic performance and output characteristics</b>							
$A_{VD}$	<b>Open Loop Gain</b> Output Voltage/Input Voltage Gain in open loop of a VFA.	$R_L = 100\Omega, V_{out} = \pm 1V$	65	67		dB	
		$T_{min.} < T_{amb} < T_{max.}$		66		dB	
Bw	<b>Bandwidth</b> Frequency where the gain is 3dB below the DC gain	Small Signal $V_{out} = 20mVp-p$ $R_L = 100\Omega$ Gain = +5 Gain = +20	30	200 43		MHz	
	<b>Gain Flatness @ 0.1dB</b> Band of frequency where the gain variation does not exceed 0.1dB	Small Signal $V_{out} = 20mVp-p$ Gain = +5		160			
SR	<b>Slew Rate</b> Maximum output speed of sweep in large signal	$V_{out} = 2Vp-p$ , Gain = +20, $R_L = 100\Omega$	160	230		V/ $\mu s$	
$V_{OH}$	<b>High Level Output Voltage</b>	$R_L = 100\Omega$	1.39	1.45		V	
		$T_{min.} < T_{amb} < T_{max.}$		1.46			
$V_{OL}$	<b>Low Level Output Voltage</b>	$R_L = 100\Omega$		-1.45	-1.39	V	
		$T_{min.} < T_{amb} < T_{max.}$		-1.46			
$I_{out}$	<b><math>I_{sink}</math></b> Short-circuit output current entering op-amp.	Output to GND	44	77		mA	
		$T_{min.} < T_{amb} < T_{max.}$		78			
	<b><math>I_{source}</math></b> Output current coming out of the op-amp.	Output to GND		-82	-44		
		$T_{min.} < T_{amb} < T_{max.}$		-78			

**Table 3. Electrical characteristics for  $V_{CC} = \pm 2.5V$ ,  $T_{amb} = 25^{\circ}C$  (unless otherwise specified)**

Symbol	Parameter	Test Condition	Min.	Typ.	Max.	Unit
<b>Noise and distortion</b>						
eN	<b>Equivalent Input Noise Voltage</b> see application note on page 13	F = 100kHz		0.65	0.77 <sup>(1)</sup>	nV/ $\sqrt{Hz}$
iN	<b>Equivalent Input Noise Current (+)</b> see application note on page 13	F = 100kHz		3.3	5.5 <sup>(1)</sup>	pA/ $\sqrt{Hz}$
SFDR	<b>Spurious Free Dynamic Range</b> The highest harmonic of the output spectrum when injecting a filtered sine wave	$V_{out} = 2V_{p-p}$ , Gain = +5, $R_L = 100\Omega$ , F = 10MHz		55		dBc

1. This parameter is guaranteed by design and evaluated using corner lots. This value is not tested in full production.

**Figure 1. Frequency response  
G=+5, SO8**

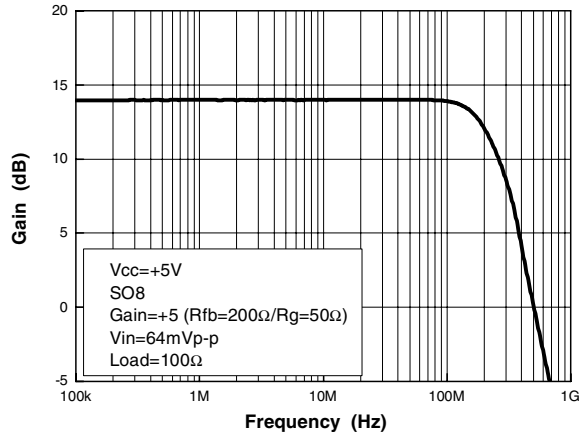

**Figure 2. Frequency response  
G=+7.8, SO8**

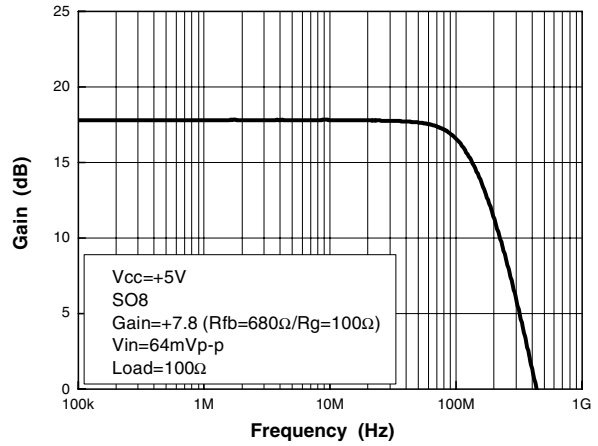

**Figure 3. Frequency response  
G=+10.2, SO8**

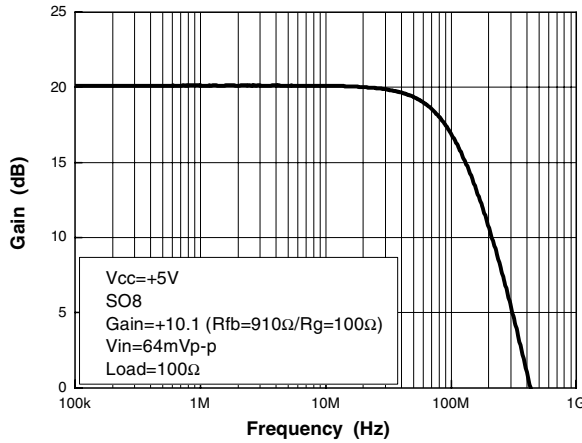

**Figure 4. Frequency response  
G=+19.9, SO8**

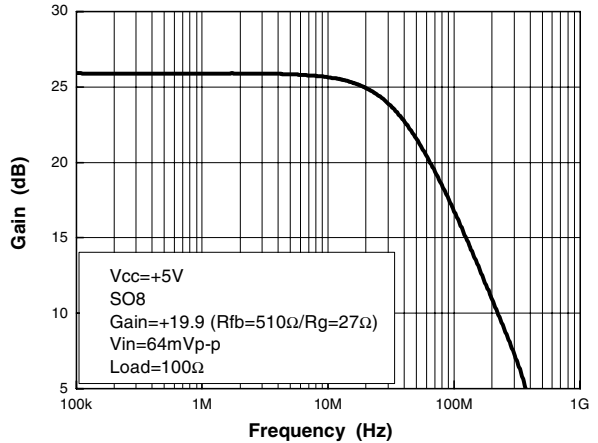

**Figure 5. Frequency response  
G=-5, SO8**

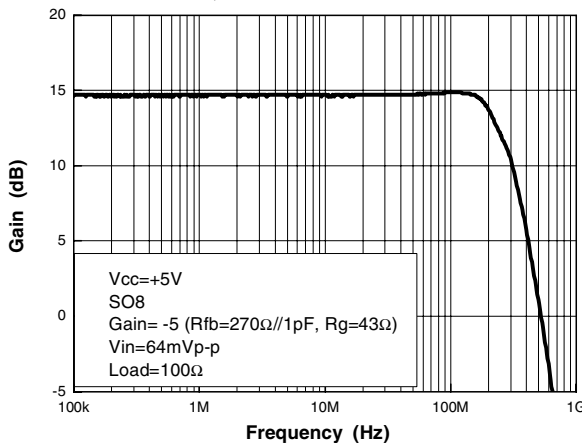

**Figure 6. Frequency response  
G=-7.8, SO8**

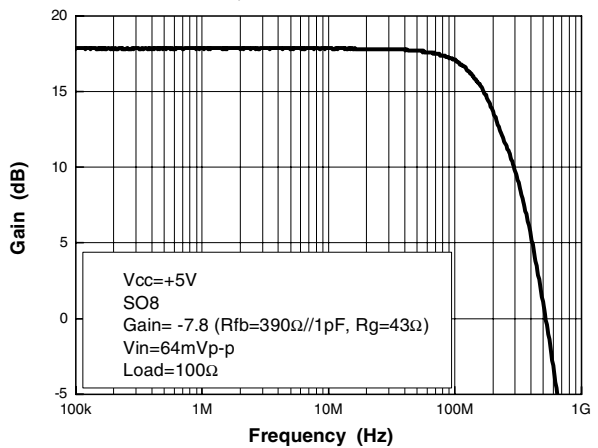

**Figure 7. Frequency response  
G=-10.2, SO8**

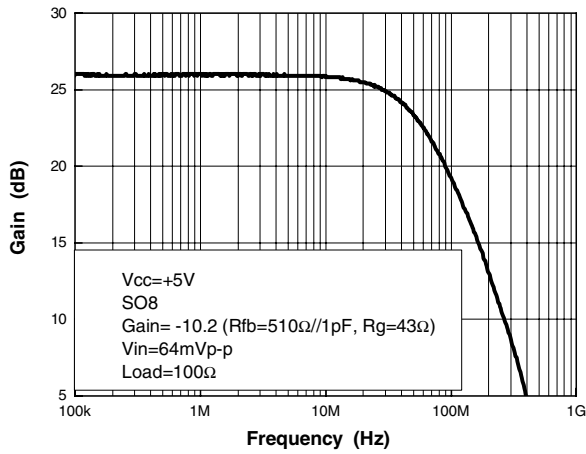

**Figure 8. Frequency response  
G=-19.9, SO8**

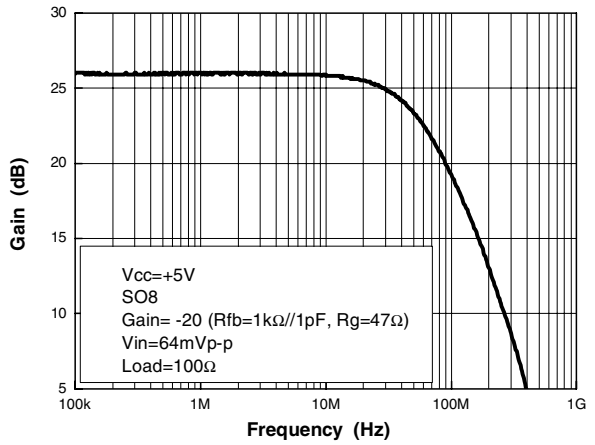

**Figure 9. Frequency response  
G=+5, SOT23-5L**

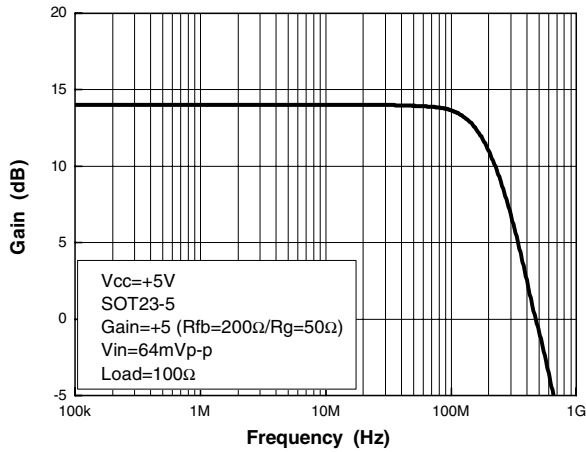

**Figure 10. Frequency response  
G=+7.8, SOT23-5L**

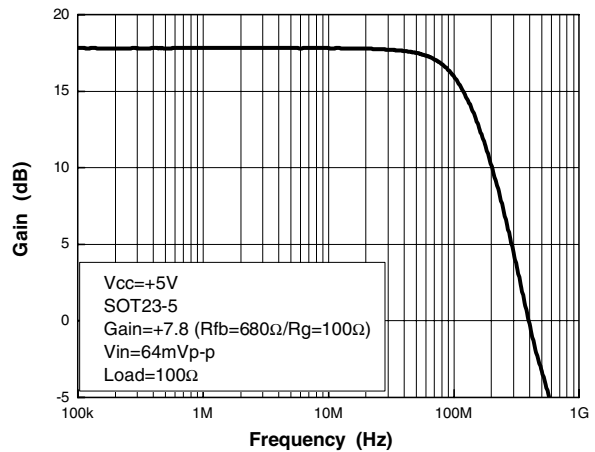

**Figure 11. Frequency response  
G=+10.1, SOT23-5L**

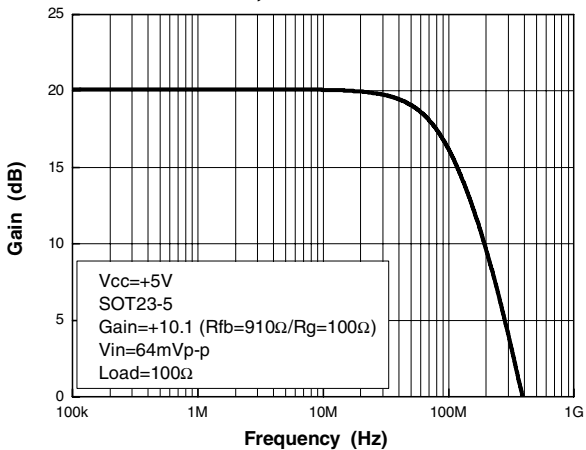

**Figure 12. Frequency response  
G=+19.9, SOT23-5L**

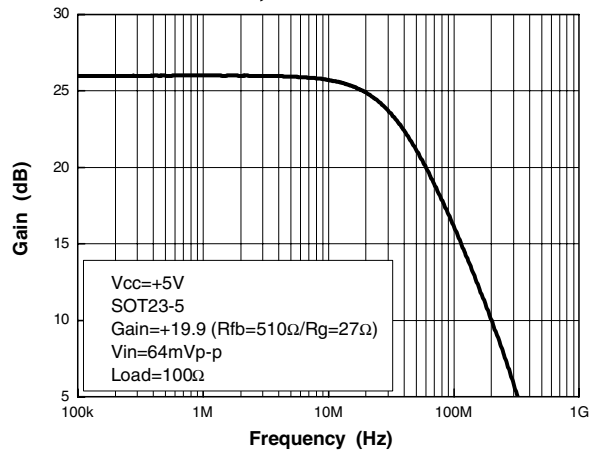

Figure 13. Gain flatness, G=+5, SO8

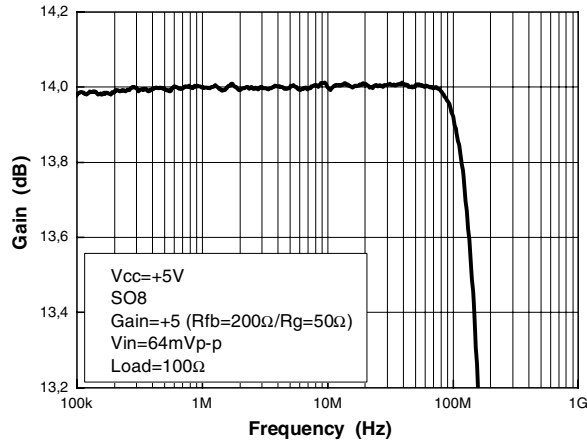

Figure 14. Gain flatness, G=+7.8, SO8

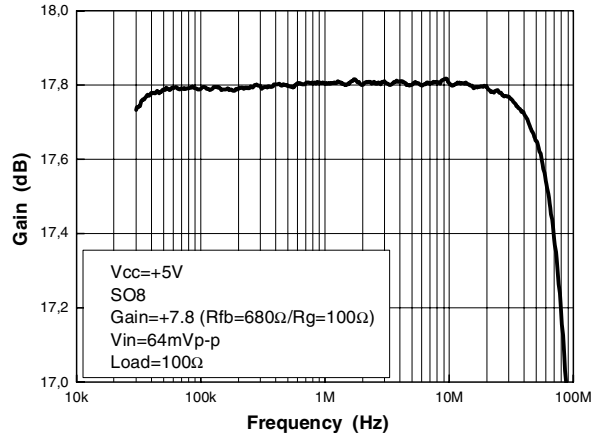

Figure 15. Gain flatness, G=+10.2, SO8

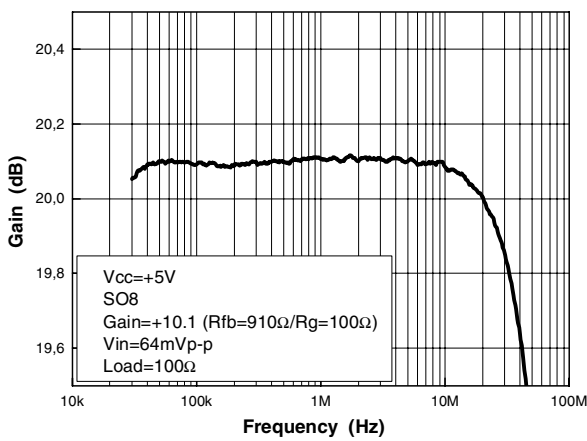

Figure 16. Gain flatness, G=+19.9, SO8

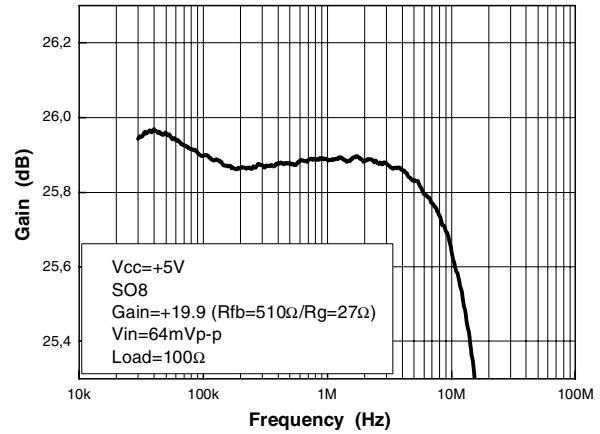

Figure 17. Gain flatness, G=+5, SOT23-5L

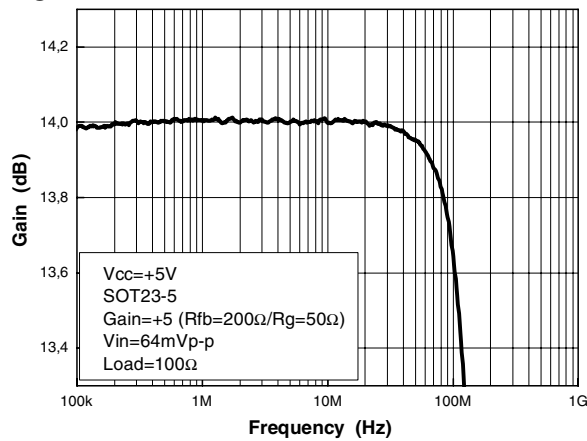

Figure 18. Gain flatness, G=+7.8, SOT23-5L

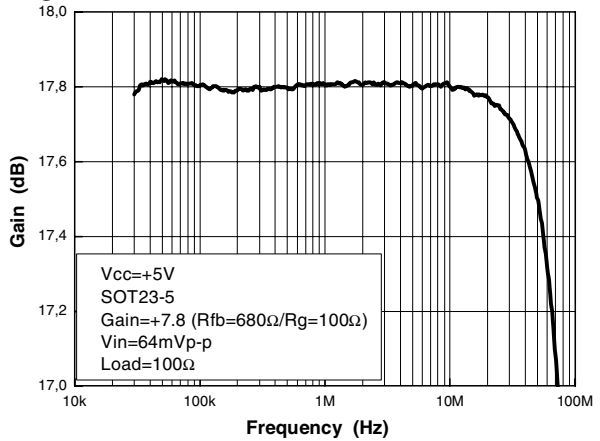

Figure 19. Gain flatness, G=+10.1, SOT23-5L

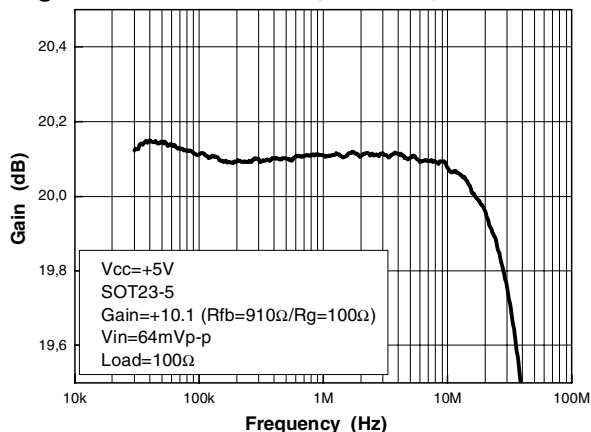

Figure 20. Gain flatness, G=+19.9, SOT23-5L

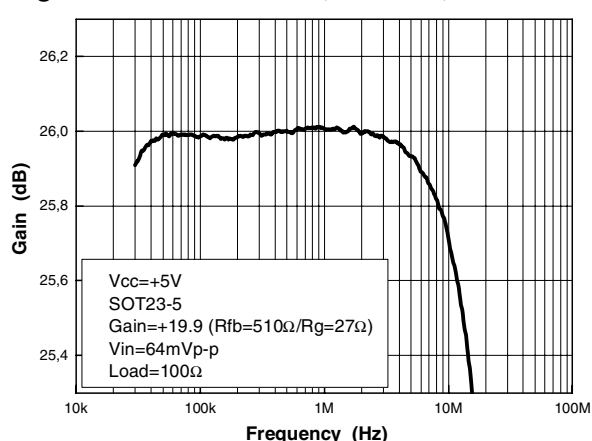

Figure 21. Input voltage noise

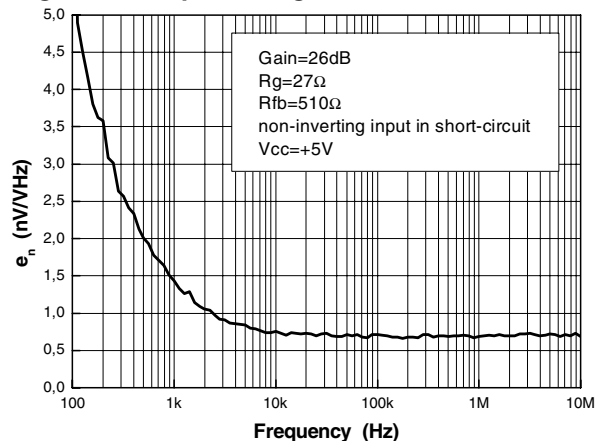

Figure 22. Input voltage noise (corner lot)

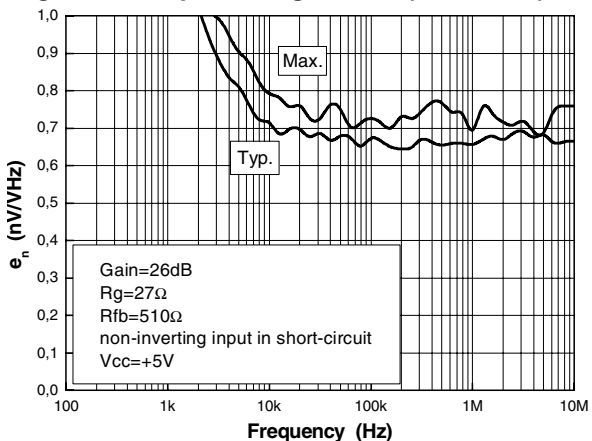

Figure 23. Input current noise

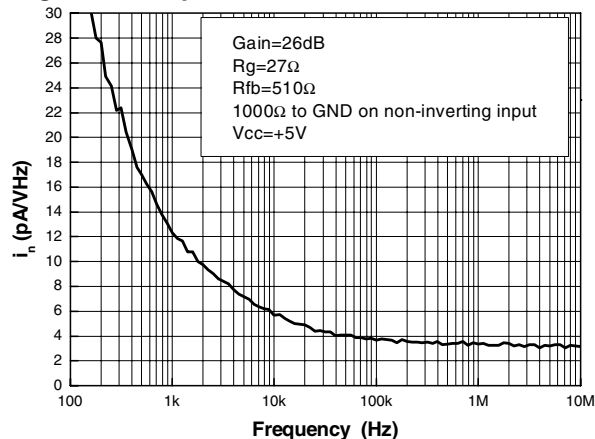

Figure 24. Input current noise (corner lot)

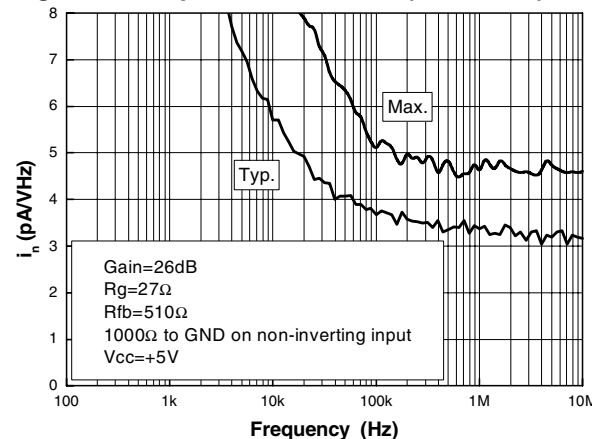

Figure 25. Distortion vs.  $V_{out}$ , SO8

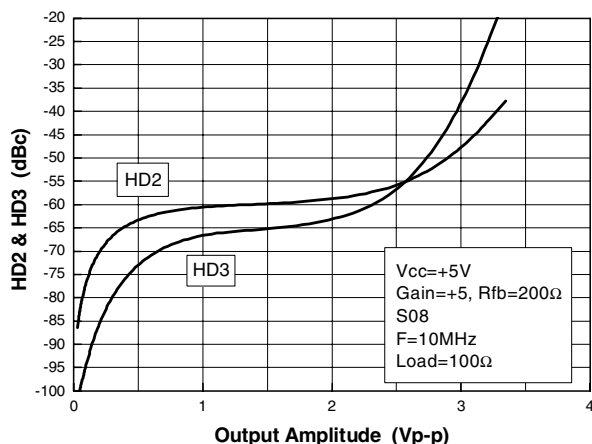

Figure 26. Distortion vs.  $V_{out}$ , SOT23-5L

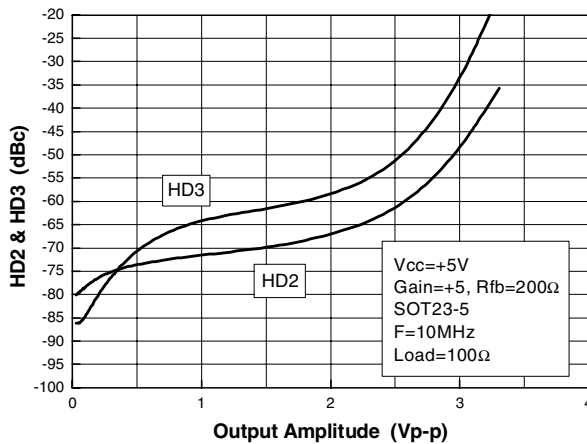

Figure 27. Slew-rate

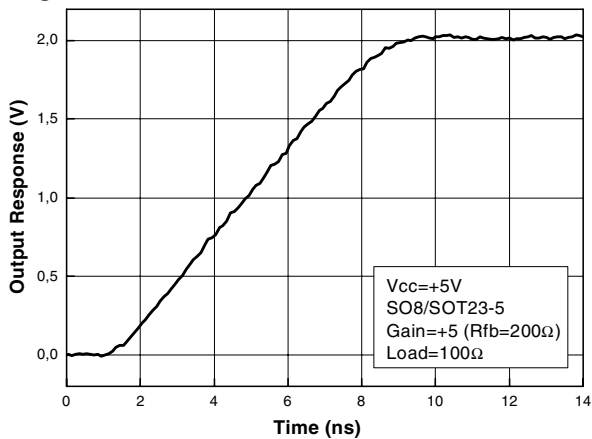

Figure 28. Reverse isolation vs. frequency

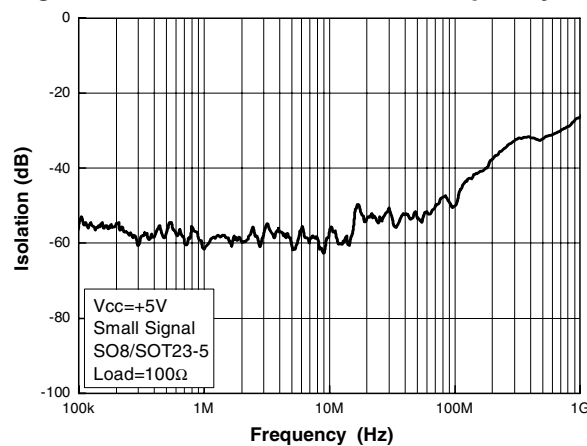

Figure 29. Quiescent current vs.  $V_{cc}$

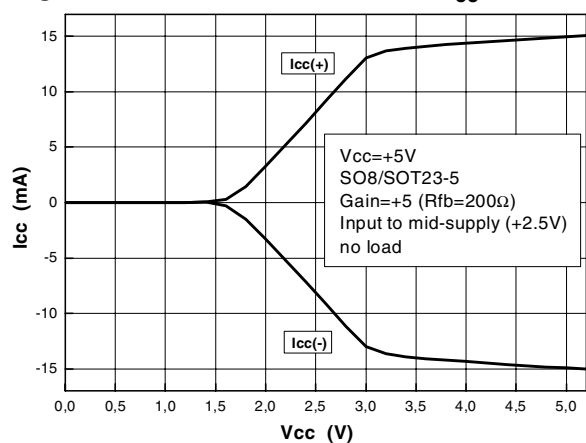

Figure 30.  $V_{out\ max}$  vs.  $V_{cc}$

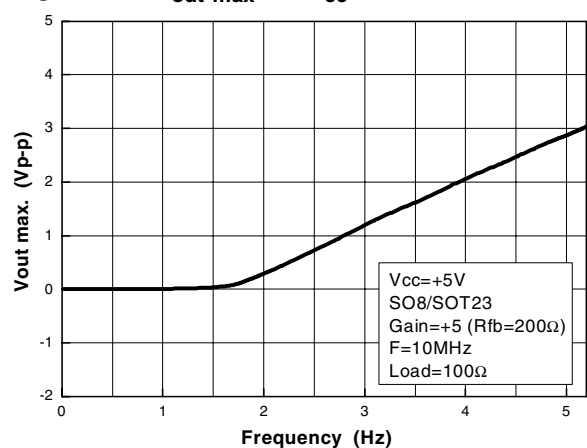

Figure 31.  $V_{IO}$  vs. temperature

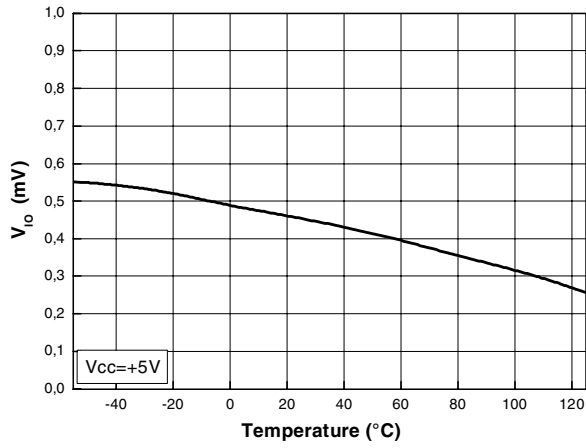

Figure 32.  $I_{BIAS}$  vs. temperature

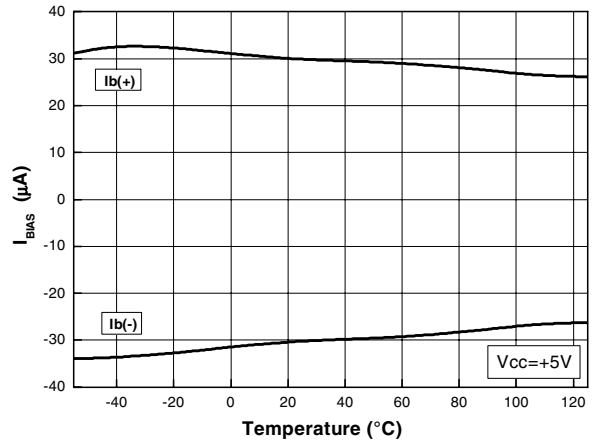

Figure 33. Supply current vs. temperature

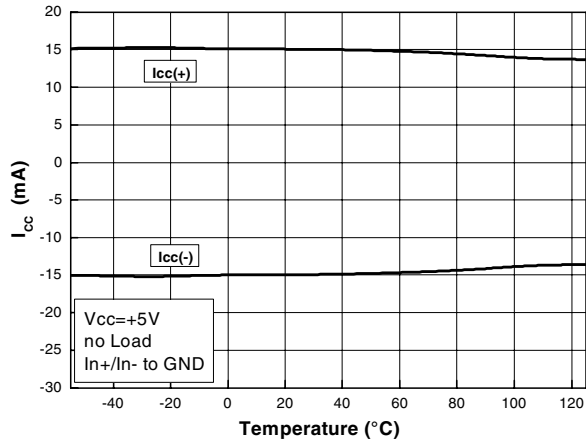

Figure 34.  $A_{VD}$  vs. temperature

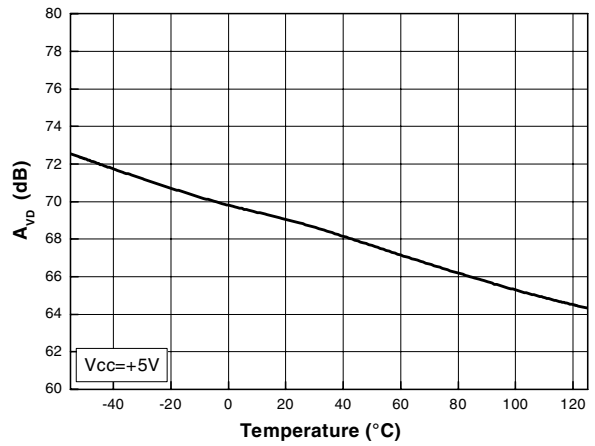

Figure 35. Output rails vs. temperature

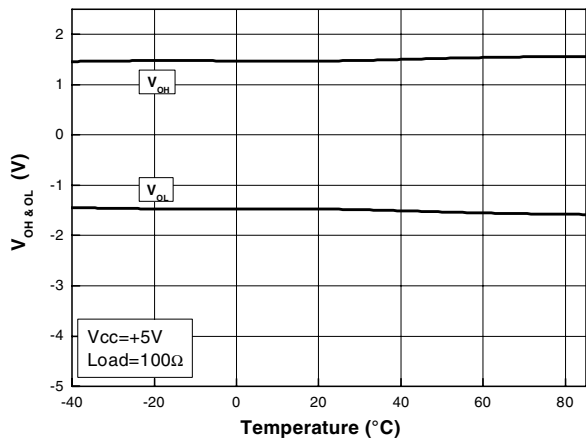

Figure 36.  $I_{out}$  vs. temperature

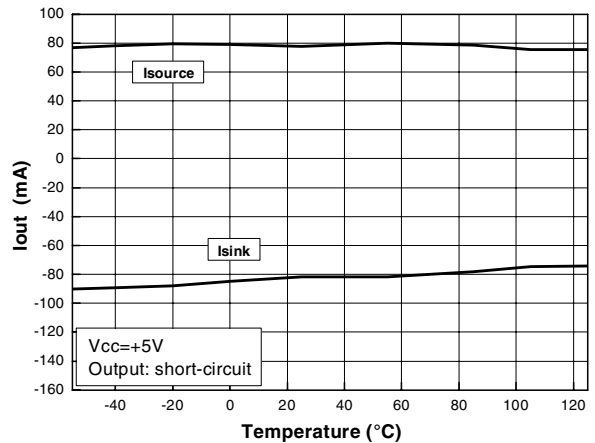

Figure 37. CMR vs. temperature

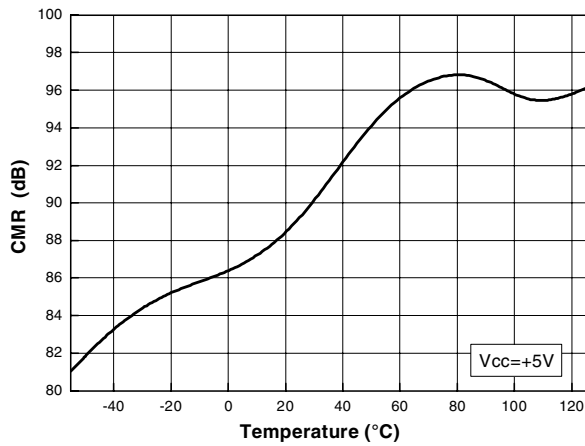

Figure 38. Bandwidth vs. temperature

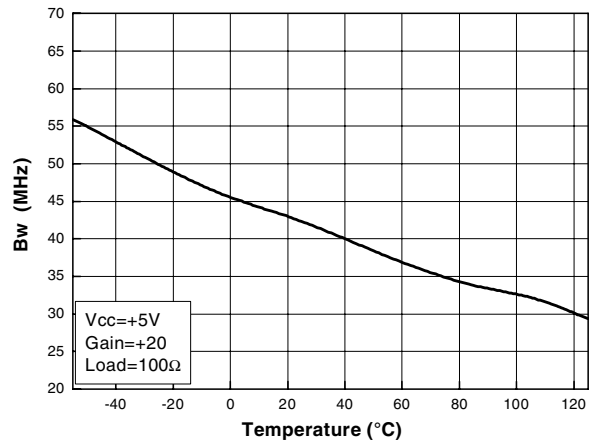

Figure 39. Slew-rate vs. temperature

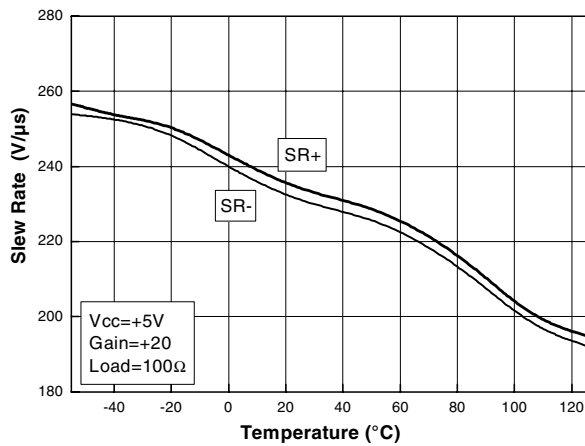

Figure 40. I<sub>sink</sub>

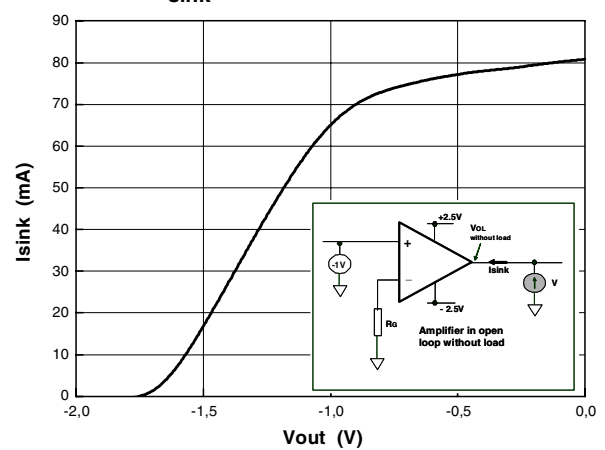

Figure 41. SVR vs. temperature

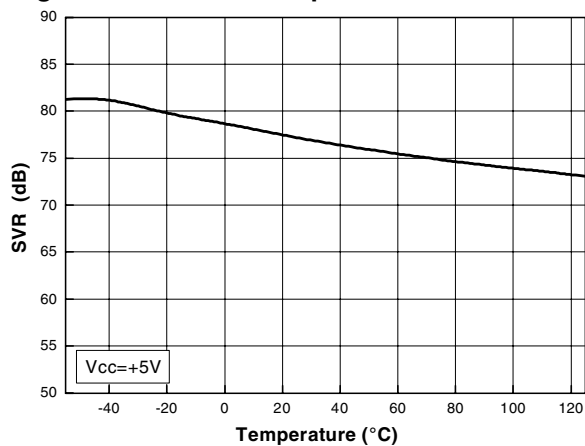
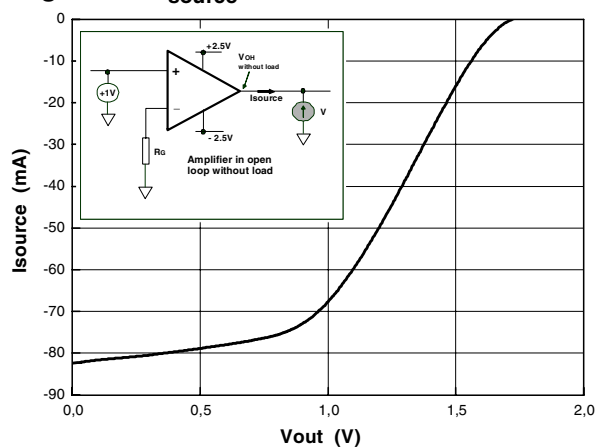

Figure 42. I<sub>source</sub>



### 3 Power Supply Considerations

Correct power supply bypassing is very important for optimizing performance in high-frequency ranges. Bypass capacitors should be placed as close as possible to the IC pins to improve high-frequency bypassing. A capacitor greater than  $1\mu\text{F}$  is necessary to minimize the distortion. For better quality bypassing, a capacitor of  $10\text{nF}$  can be added using the same implementation conditions. Bypass capacitors must be incorporated for both the negative and the positive supply.

**Figure 43. Circuit for power supply bypassing**

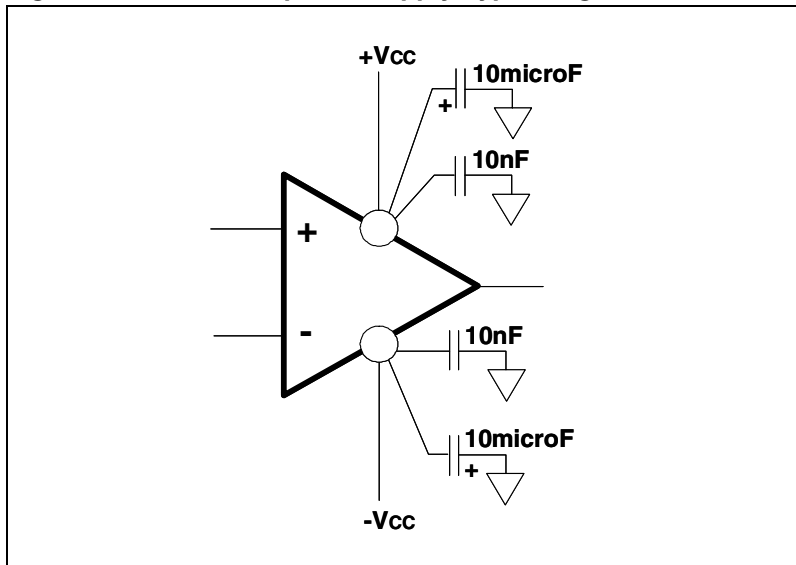

## 4 Evaluation Boards

An evaluation board kit optimized for high-speed operational amplifiers is available (order code: KITHSEVAL/STD). The kit includes the following evaluation boards, as well as a CD-ROM containing datasheets, articles, application notes and a user manual:

- SOT23\_SINGLE\_HF BOARD: Board for the evaluation of a single high-speed op-amp in SOT23-5L package.
- SO8\_SINGLE\_HF: Board for the evaluation of a single high-speed op-amp in SO8 package.
- SO8\_DUAL\_HF: Board for the evaluation of a dual high-speed op-amp in SO8 package.
- SO8\_S\_MULTI: Board for the evaluation of a single high-speed op-amp in SO8 package in inverting and non-inverting configuration, dual and single supply.
- SO14\_TRIPLE: Board for the evaluation of a triple high-speed op-amp in SO14 package with video application considerations.

Board material description:

- 2 layers
- FR4 ( $\epsilon_r=4.6$ )
- epoxy 1.6mm
- copper thickness: 35 $\mu$ m

**Figure 44. Evaluation kit for high-speed op-amps**



# 5 Noise Measurements

The noise model is shown in *Figure 45*, where:

- eN: input voltage noise of the amplifier
- iNn: negative input current noise of the amplifier
- iNp: positive input current noise of the amplifier

**Figure 45. Noise model**

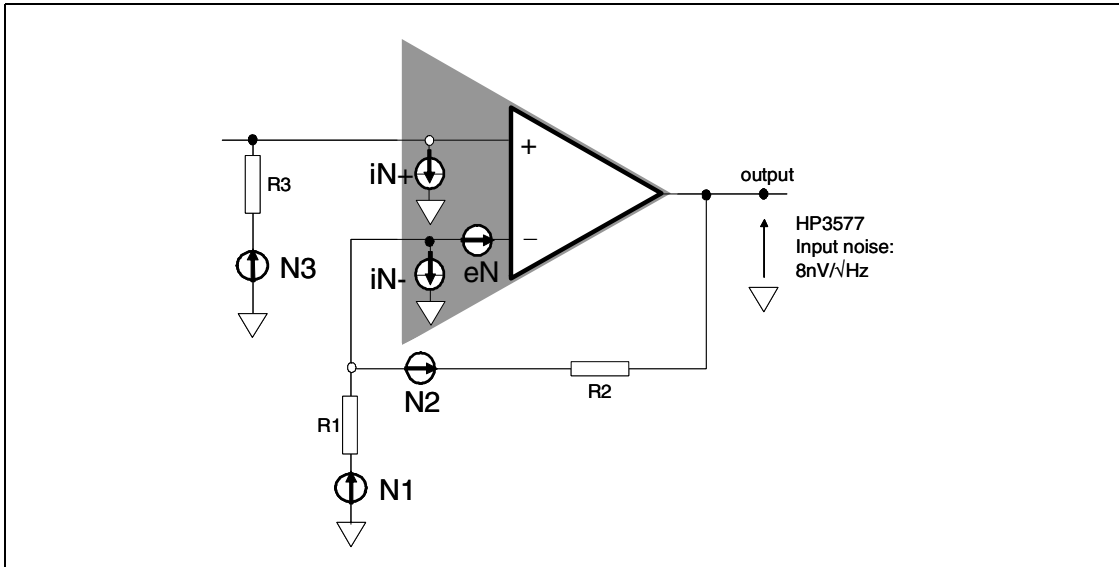

The thermal noise of a resistance R is:

$$\sqrt{4kTR\Delta F}$$

where  $\Delta F$  is the specified bandwidth.

On a 1Hz bandwidth the thermal noise is reduced to

$$\sqrt{4kTR}$$

where k is the Boltzmann's constant, equal to  $1,374.10^{-23} \text{J/}^\circ\text{K}$ . T is the temperature ( $^\circ\text{K}$ ).

The output noise eNo is calculated using the Superposition Theorem. However eNo is not the simple sum of all noise sources, but rather the square root of the sum of the square of each noise source, as shown in Equation 1:

$$eNo = \sqrt{V1^2 + V2^2 + V3^2 + V4^2 + V5^2 + V6^2} \quad (\text{Equation 1})$$

$$eNo^2 = eN^2 \times g^2 + iNn^2 \times R2^2 + iNp^2 \times R3^2 \times g^2 + \left(\frac{R2}{R1}\right)^2 \times 4kTR1 + 4kTR2 + g^2 \times 4kTR3 \quad (\text{Equation 2})$$

The input noise of the instrumentation must be extracted from the measured noise value. The real output noise value of the driver is:

$$eNo = \sqrt{(\text{Measured})^2 - (\text{instrumentation})^2} \quad (\text{Equation 3})$$

The input noise is called the Equivalent Input Noise as it is not directly measured but is evaluated from the measurement of the output divided by the closed loop gain ( $eNo/g$ ).

After simplification of the fourth and the fifth term of Equation 2 we obtain:

$$eNo^2 = eN^2 \times g^2 + iNn^2 \times R2^2 + iNp^2 \times R3^2 \times g^2 + g \times 4kTR2 + g^2 \times 4kTR3 \quad (\text{Equation 4})$$

### Measurement of the input voltage noise $eN$

If we assume a short-circuit on the non-inverting input ( $R3=0$ ), from Equation 4 we can derive:

$$eNo = \sqrt{eN^2 \times g^2 + iNn^2 \times R2^2 + g \times 4kTR2} \quad (\text{Equation 5})$$

In order to easily extract the value of  $eN$ , the resistance  $R2$  will be chosen to be as low as possible. In the other hand, the gain must be large enough:

$$R3=0, \text{ gain: } g=100$$

### Measurement of the negative input current noise $iNn$

To measure the negative input current noise  $iNn$ , we set  $R3=0$  and use Equation 5. This time the gain must be lower in order to decrease the thermal noise contribution:

$$R3=0, \text{ gain: } g=10$$

### Measurement of the positive input current noise $iNp$

To extract  $iNp$  from Equation 3, a resistance  $R3$  is connected to the non-inverting input. The value of  $R3$  must be chosen in order to keep its thermal noise contribution as low as possible against the  $iNp$  contribution:

$$R3=100\Omega, \text{ gain: } g=10$$

## 6 Package Mechanical Data

In order to meet environmental requirements, ST offers these devices in ECOPACK® packages. These packages have a Lead-free second level interconnect. The category of second level interconnect is marked on the package and on the inner box label, in compliance with JEDEC Standard JESD97. The maximum ratings related to soldering conditions are also marked on the inner box label. ECOPACK is an ST trademark. ECOPACK specifications are available at: [www.st.com](http://www.st.com).

### 6.1 SOT23-5L package

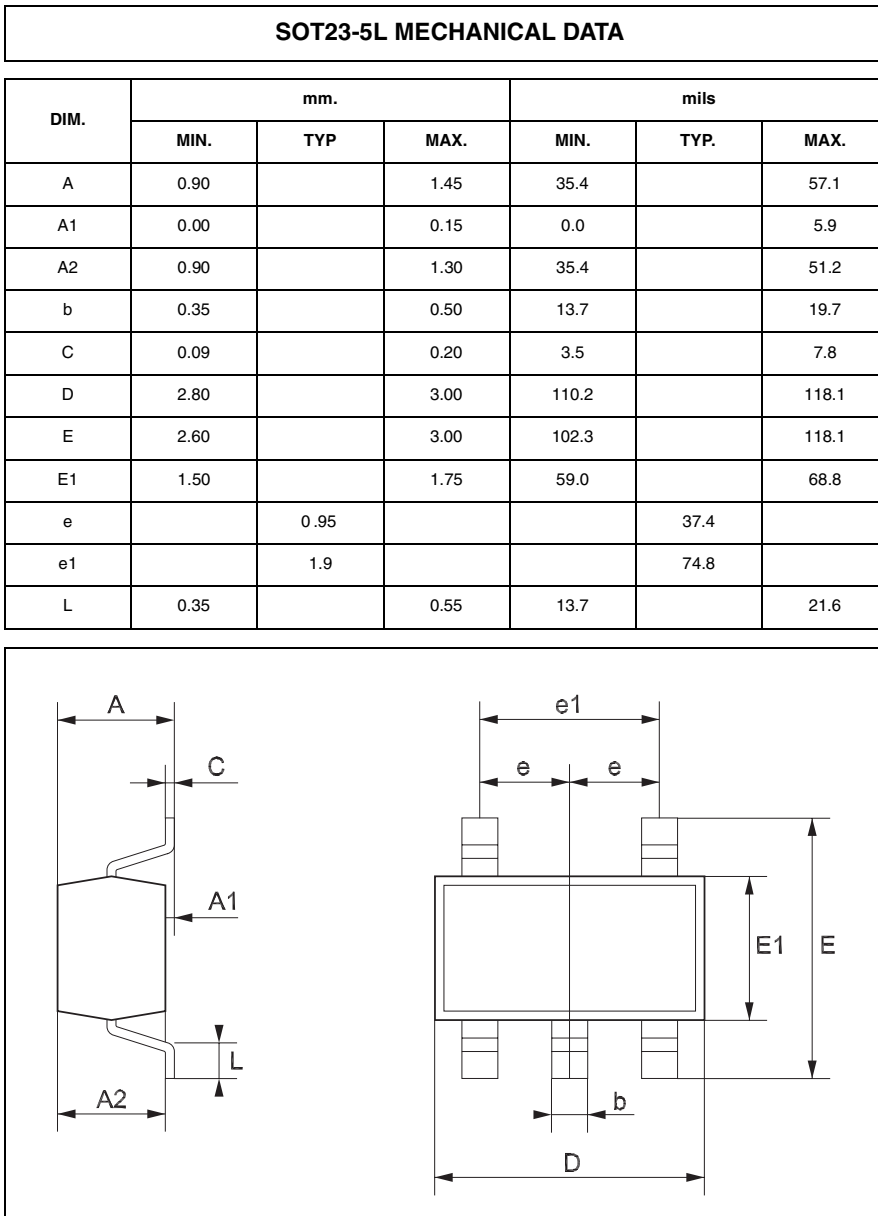

## 6.2 SO8 package

**SO-8 MECHANICAL DATA**

DIM.	mm.			inch		
	MIN.	TYP.	MAX.	MIN.	TYP.	MAX.
A	1.35		1.75	0.053		0.069
A1	0.10		0.25	0.04		0.010
A2	1.10		1.65	0.043		0.065
B	0.33		0.51	0.013		0.020
C	0.19		0.25	0.007		0.010
D	4.80		5.00	0.189		0.197
E	3.80		4.00	0.150		0.157
e		1.27			0.050	
H	5.80		6.20	0.228		0.244
h	0.25		0.50	0.010		0.020
L	0.40		1.27	0.016		0.050
k	$g^\circ$ (max.)					
ddd			0.1			0.04

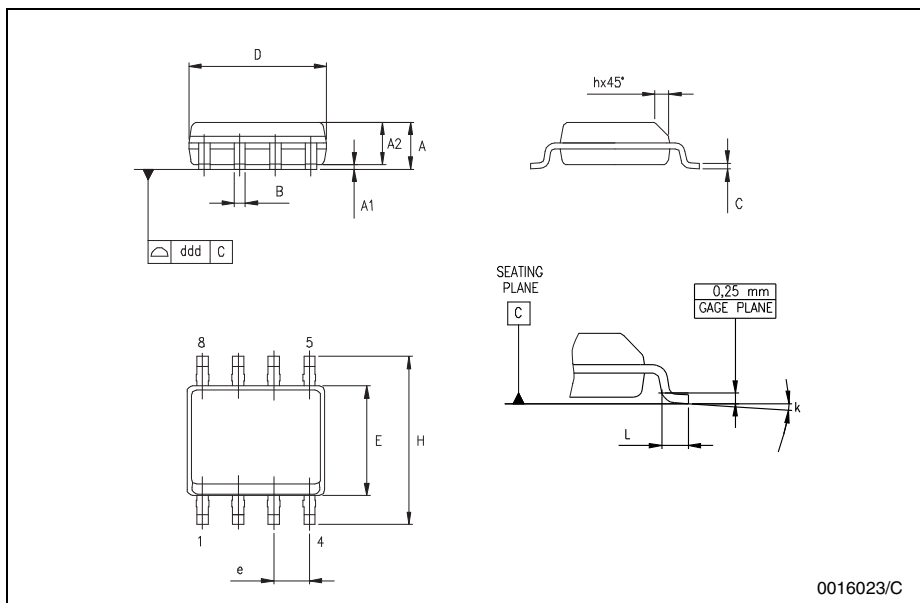

## 7 Revision History

Date	Revision	Description of Changes
Sept. 2005	1	Release of mature product datasheet
Sept. 2005	2	Update to ESD information in <a href="#">Table 1 on page 2</a> .

Information furnished is believed to be accurate and reliable. However, STMicroelectronics assumes no responsibility for the consequences of use of such information nor for any infringement of patents or other rights of third parties which may result from its use. No license is granted by implication or otherwise under any patent or patent rights of STMicroelectronics. Specifications mentioned in this publication are subject to change without notice. This publication supersedes and replaces all information previously supplied. STMicroelectronics products are not authorized for use as critical components in life support devices or systems without express written approval of STMicroelectronics.

The ST logo is a registered trademark of STMicroelectronics.  
All other names are the property of their respective owners

© 2005 STMicroelectronics - All rights reserved

STMicroelectronics group of companies

Australia - Belgium - Brazil - Canada - China - Czech Republic - Finland - France - Germany - Hong Kong - India - Israel - Italy - Japan - Malaysia - Malta - Morocco - Singapore - Spain - Sweden - Switzerland - United Kingdom - United States of America

[www.st.com](http://www.st.com)

## Looking for pricing, stock, or lifecycle information?

Click below to explore more details on WIN SOURCE:

- ⊖ [View TSH300IDT on WIN SOURCE](#)
- ⊖ [STMicroelectronics](#) Information

## Optimize Your Supply Chain with WIN SOURCE Solutions

- ✓ Global Sourcing Solution
- ✓ Obsolete Management
- ✓ Cost Control Management
- ✓ Shortage Management
- ✓ Alternative Solution
- ✓ Excess Inventory Management