



**THE DATASHEET OF  
R570463100**



## RF CHARACTERISTICS

Frequency range : **0 - 18 GHz**  
Impedance : **50 Ohms**

Frequency (GHz)	DC - 3	3 - 8	8 - 12.4	12.4 - 18
VSWR max	<b>1.10</b>	<b>1.20</b>	<b>1.20</b>	<b>1.40</b>
Insertion loss max	<b>0.15 dB</b>	<b>0.20 dB</b>	<b>0.25 dB</b>	<b>0.35 dB</b>
Isolation min	<b>80 dB</b>	<b>75 dB</b>	<b>65 dB</b>	<b>60 dB</b>
Average power (*)	<b>240 W</b>	<b>150 W</b>	<b>120 W</b>	<b>100 W</b>

## ELECTRICAL CHARACTERISTICS

Actuator : **LATCHING**  
Nominal current \*\* : **80 mA**  
Actuator voltage (Vcc) : **28V (24 to 30V)**  
Terminals : **solder pins (250°C max. / 30 sec.)**  
Indicator rating : **1 W / 30 V / 100 mA**  
Self cut-off time : **40 ms < CT < 120 ms**  
TTL inputs (E) - High level : **2.2 to 5.5 V / 800µA at 5.5 V**  
- Low level : **0 to 0.8 V / 20µA at 0.8 V**

## MECHANICAL CHARACTERISTICS

Connectors : **SMA female per MIL-C 39012**  
Life : **10 million cycles**  
Switching Time\*\*\* : **< 10 ms**  
Construction : **Splashproof**  
Weight : **< 45 g**

## ENVIRONMENTAL CHARACTERISTICS

Operating temperature range : **-40°C to +85°C**  
Storage temperature range : **-55°C to +85°C**

- (\* Average power at 25°C per RF Path)  
(\*\* At 25° C ±10%)  
(\*\*\* Nominal voltage ; 25° C)



PAGE 2/2

ISSUE 22-03-22

SERIE : SPDT

PART NUMBER : R570463100

DRAWING

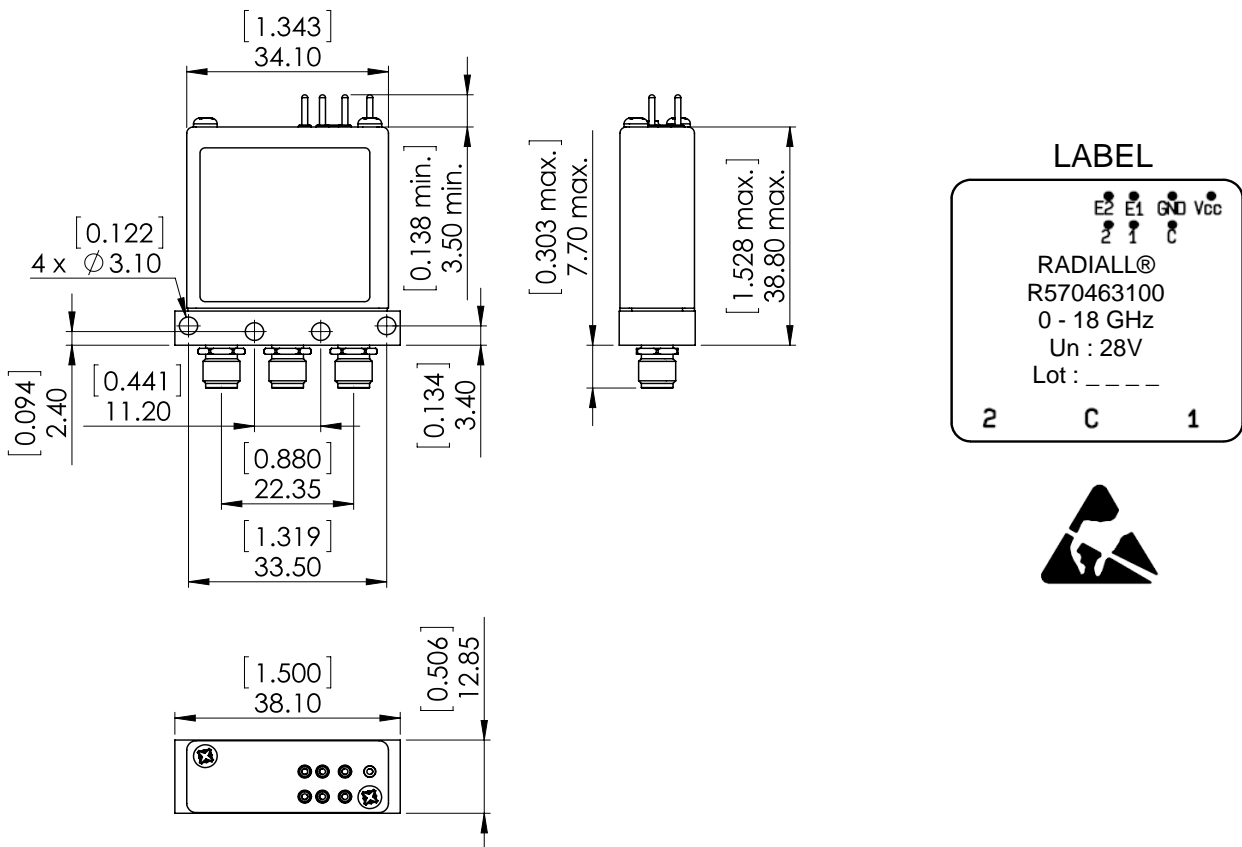

General tolerances : ±0,5 mm [0,02 in]

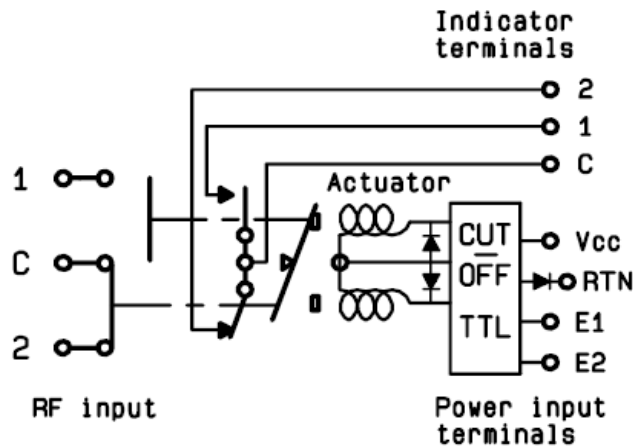

SCHEMATIC DIAGRAM









TTL input	RF Continuity	Ind.
E1=1 / E2=0	C ↔ 1	C.1
E1=0 / E2=1	C ↔ 2	C.2
E1=0 / E2=0	Memory	-
E1=1 / E2=1	Forbidden	-

## Looking for pricing, stock, or lifecycle information?

Click below to explore more details on WIN SOURCE:

-  [View R570463100 on WIN SOURCE](#)
-  [Radiall USA, Inc. Information](#)

## Optimize Your Supply Chain with WIN SOURCE Solutions

-  Global Sourcing Solution
-  Obsolete Management
-  Cost Control Management
-  Shortage Management
-  Alternative Solution
-  Excess Inventory Management