



THE DATASHEET OF DELTA2A/X/SMAM/S/RA/11





Delta 2A

Quad Band GSM, 3G & ISM Stubby Antenna

Key Features

- Small size
- Quad band GSM and 3G
- ISM: 868 and 915MHz
- Groundplane independent



General Description

The Delta 2A Multiband antenna combines good performance with a small size, enabling its use with many of today's GSM / GPRS, 3G and ISM products.

The omni directional, radiating element is over moulded in black high-grade rubber, which allows flexibility and provides a rugged stylish finish.

Terminated with an SMA male or SMA RP right angle connector, it is suited to applications like Point of Sale terminals, metering or alarm panel equipment.

Additional Considerations

- Suitable for GSM / GPRS and 3G terminal equipment
- Meets all EU compliance criteria for electronic goods





Delta 2A

Quad Band GSM, 3G & ISM Stubby Antenna

Electrical Specifications

Operating Temperature range:	-20 - +60°C
Storage Temperature range:	-30 - +75°C
Impedance:	50 Ohm
VSWR:	2.0
Gain:	2.0 dBi
Operating Frequencies:	GSM: 800, 900, 1800, 1900MHz 3G: 2100MHz ISM: 868, 915MHz
Radiation:	Omni Directional
Polarization:	Vertical

Mechanical Specifications

Dimensions:	L53.5mm
Connector:	Right angle SMA male, SMA RP
Mounting Method:	Direct connect
Connector plating:	Gold/Nickel

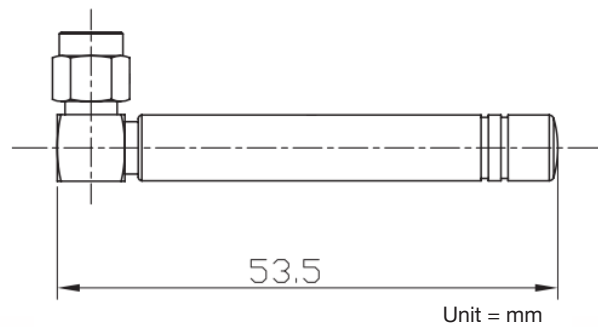

Return Loss

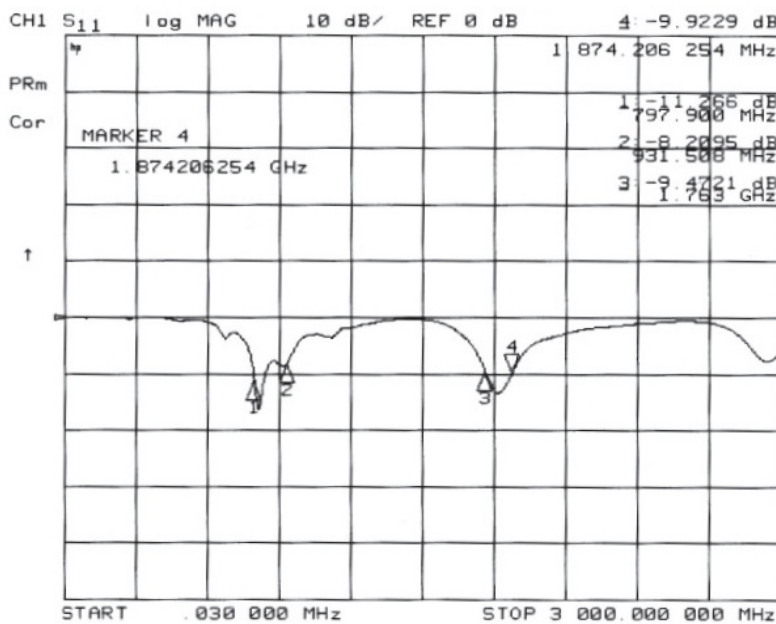

VSWR

Frequency	dB
797.9 MHz	1.752
931.5 MHz	2.271
1763 MHz	2.012
1874 MHz	1.937



Delta 2A

Quad Band GSM, 3G & ISM Stubby Antenna

Radiation Plots

836.5MHz

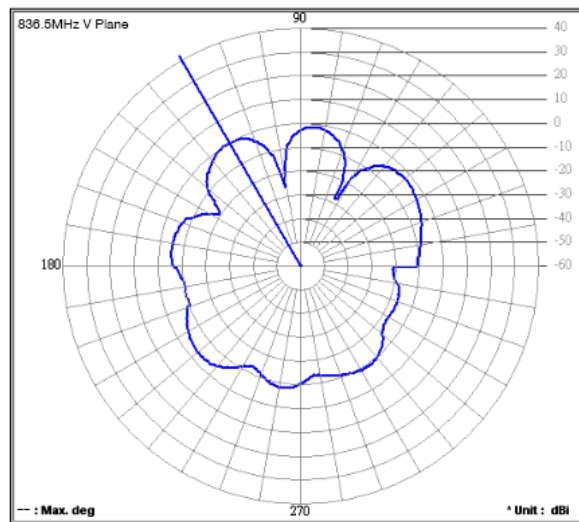
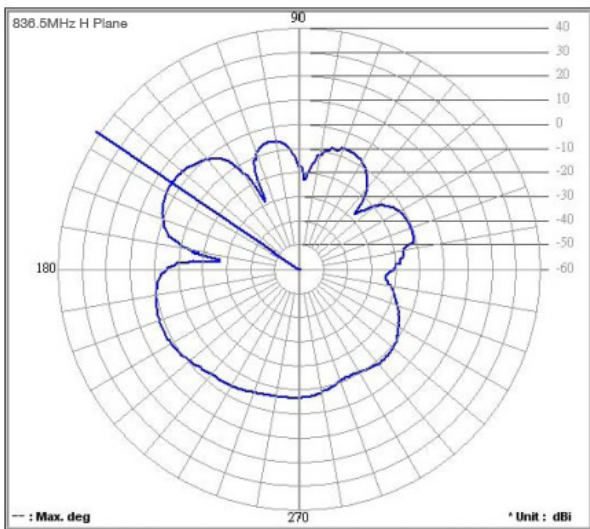

897.4 MHz

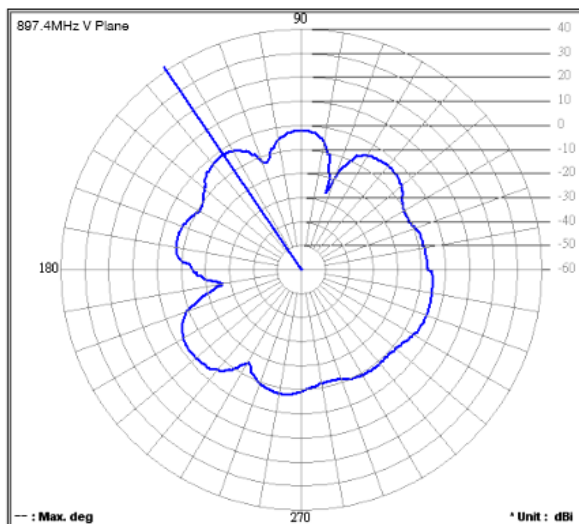
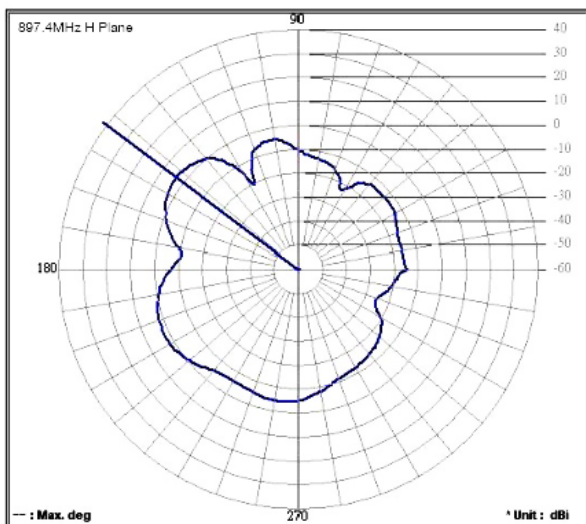



Delta 2A

Quad Band GSM, 3G & ISM Stubby Antenna

1747.4 MHz

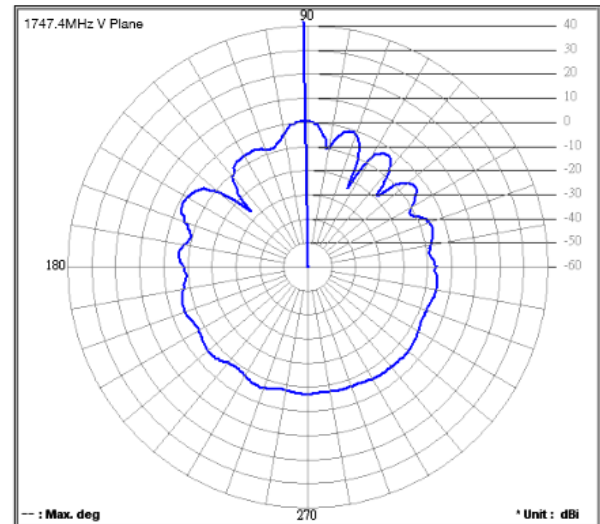
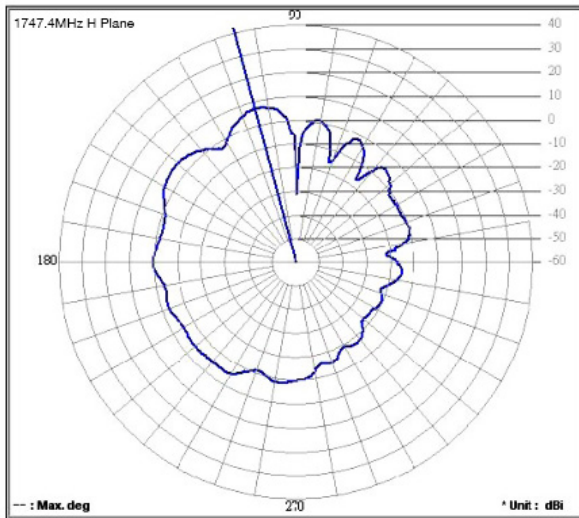

1868 MHz

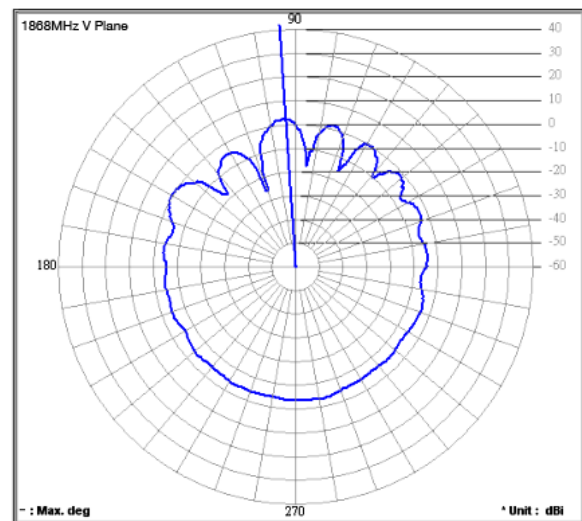
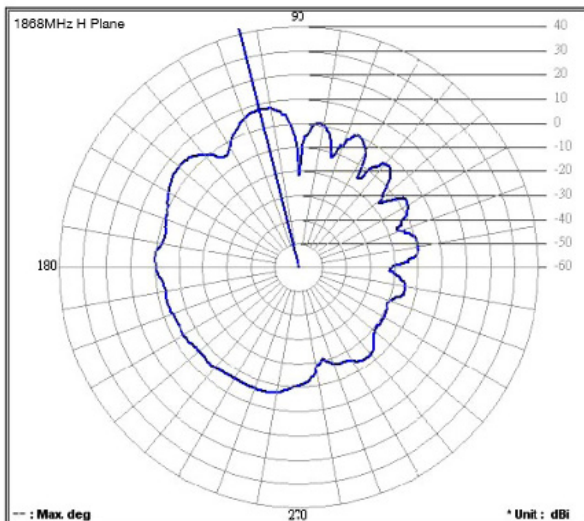



Ordering Details

Part number	Description
DELTA2A/X/SMAM/S/RA/11	Quad Band GSM/GPRS 3G & ISM Antenna SMA Male Right Angle

Looking for pricing, stock, or lifecycle information?

Click below to explore more details on WIN SOURCE:

-  [View DELTA2A/X/SMAM/S/RA/11 on WIN SOURCE](#)
-  [Siretta Ltd Information](#)

Optimize Your Supply Chain with WIN SOURCE Solutions

-  Global Sourcing Solution
-  Obsolete Management
-  Cost Control Management
-  Shortage Management
-  Alternative Solution
-  Excess Inventory Management