



**THE DATASHEET OF
LTC6228IDC#TRPBF**



0.88nV/ $\sqrt{\text{Hz}}$ 730MHz, 500V/ μs ,
Low Distortion Rail-to-Rail Output Op
Amps with Shutdown

FEATURES

- Ultra Low Voltage Noise: 0.88nV/ $\sqrt{\text{Hz}}$
- Low Distortion at High Speeds:
HD2/HD3 < -100dBc ($A_v = +1$, 4V_{p-p}, 2MHz, R_L = 1k Ω)
- High Slew Rate: 500V/ μs
- GBW = 890MHz
- -3dB Frequency ($A_v = +1$): 730MHz
- Input Offset Voltage: 250 μV Max Across Temperature
- Offset Drift :0.4 $\mu\text{V}/^\circ\text{C}$
- Input Common Mode Range Includes Negative Rail
- Output Swings Rail-to-Rail
- Supply Current: 16mA/Channel Typ
- Shutdown Supply Current = 500 μA
- Operating Supply Range: 2.8V to 11.75V
- Large Output Current: 80mA Min
- Very High Open Loop Gain: 5.6V/ μV (135dB), R_L = 1k Ω
- Operating Temp Range: -40 $^\circ\text{C}$ to 125 $^\circ\text{C}$
- Singles in 8-Lead SOIC, TSOT-23, DC-6, Duals in DD10, MS8

APPLICATIONS

- Optical Electronics: Fast Transimpedance Amplifiers
- Driving High Dynamic Range A/D Converters
- Active Filters
- Video Amplifiers
- High Speed Differential to Single-Ended Conversion
- Low Voltage Hi-Fi Amplification

All registered trademarks and trademarks are the property of their respective owners.

DESCRIPTION

The LTC[®]6228/LTC6229 are single/dual very fast, low noise rail-to-rail output, unity gain stable op amps. They have a gain-bandwidth product of 890MHz and a slew rate of 500V/ μs . The low input referred voltage noise of only 0.88nV/ $\sqrt{\text{Hz}}$ and low distortion performance of better than -100dB at 4V_{p-p} even for signals as fast as 2MHz make them ideal for applications that require high dynamic range and deal with high slew rate signals, such as driving A/D converters. Additional features include Shutdown and the ability to enable/disable internal bias current cancellation to optimize noise performance.

The combination of low offset, low offset drift, high gain and high CMRR make the LTC6228 family the superior choice for wide dynamic range applications.

The LTC6228 family maintains excellent performance for supply voltages of 2.8V to 11.75V and the devices are specified at supplies of 3V, 5V and 10V($\pm 5\text{V}$). With an input range extending to the negative rail and an output range that encompasses the entire supply range, the operational amplifier can accommodate wide swinging signals, and single supply operation.

For space constrained PCB layouts, the LTC6228 is available in a 2mm \times 2mm DFN and the LTC6229 is available in a 3mm \times 3mm DFN. The amplifiers are also available in conventional leaded packages. These amplifiers can be used as improved replacements for many high speed op amps to improve speed, noise, distortion and dynamic range.

TYPICAL APPLICATION

LTC6228 Based Driver for the LTC2387-18 SAR ADC

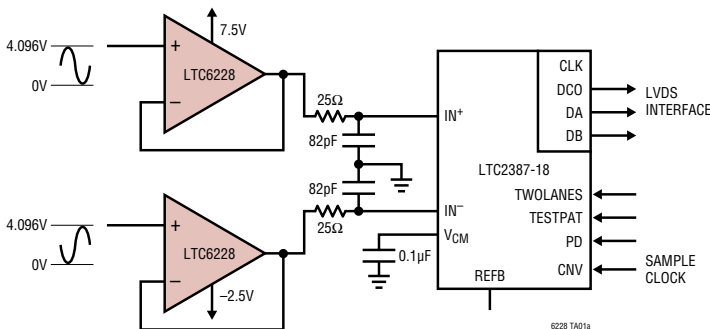

System Performance: 2 x LTC6228 Driving LTC2387-18
8192 Point FFT, -1dBFS
f_{SAMPL} = 15Mpsps, f_{IN} = 1MHz

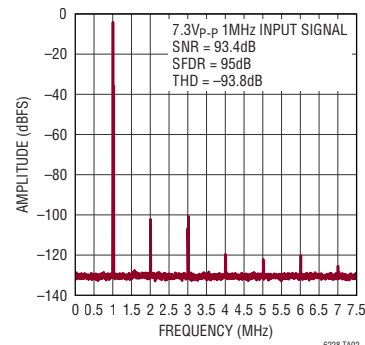

ABSOLUTE MAXIMUM RATINGS (Note 1)

| | | | |
|-------------------------------------------------------------------|--------------------------------------------|----------------------------------------|--------------------------------------------|
| Total Supply Voltage (V^- to V^+) | 12V | Output Current (OUT, FB)(Note 3) | $\pm 100\text{mA}$ |
| Input Voltage ($-IN$, $+IN$, \overline{SHDN}).... | $V^- - 0.3\text{V}$ to $V^+ + 0.3\text{V}$ | Output Short-Circuit Duration | Thermally Limited |
| Input Current ($-IN$, $+IN$, \overline{SHDN}) (Note 2)..... | $\pm 10\text{mA}$ | Storage Temperature Range | -65°C to 150°C |
| Operating Temperature Range | | Maximum Junction Temperature | 150°C |
| LTC6228I/LTC6229I (Note 4)..... | -40°C to 85°C | Lead Temperature (Soldering 10s) | |
| LTC6228H/LTC6229H (Note 4)..... | -40°C to 125°C | (MSOP/S8/TSOT Only) | 300°C |
| Specified Temperature Range | | | |
| LTC6228I/LTC6229I (Note 4)..... | -40°C to 85°C | | |
| LTC6228H/LTC6229H (Note 4)..... | -40°C to 125°C | | |

PIN CONFIGURATION

| | |
|---------------------------------------------------------------------------------------------------------------------------------------------------------------------------------------------------------------------------------------------------------------------------------------------------------|-----------------------------------------------------------------------------------------------------------------------------------------------------------------------------------------------------------------------------------------------------------------------------------------------------------|
| <p style="text-align: center;">TOP VIEW</p> <p style="text-align: center;">S8 PACKAGE 8-LEAD PLASTIC SO $T_{JMAX} = 150^\circ\text{C}$, $\theta_{JA} = 120^\circ\text{C/W}$ (NOTE 7)</p> | <p style="text-align: center;">TOP VIEW</p> <p style="text-align: center;">S6 PACKAGE 6-LEAD PLASTIC TSOT-23 $T_{JMAX} = 150^\circ\text{C}$, $\theta_{JA} = 192^\circ\text{C/W}$ (NOTE 7)</p> |
| <p style="text-align: center;">TOP VIEW</p> <p style="text-align: center;">DC PACKAGE 6-LEAD (2mm x 2mm) PLASTIC DFN $T_{JMAX} = 150^\circ\text{C}$, $\theta_{JA} = 80^\circ\text{C/W}$ (NOTE 7) EXPOSED PAD (PIN 7) IS V^-, MUST BE SOLDERED TO PCB</p> | <p style="text-align: center;">TOP VIEW</p> <p style="text-align: center;">DD PACKAGE 10-LEAD (3mm x 3mm) PLASTIC DFN $T_{JMAX} = 125^\circ\text{C}$, $\theta_{JA} = 43^\circ\text{C/W}$ (NOTE 2) EXPOSED PAD (PIN 11) IS V^-, MUST BE SOLDERED TO PCB</p> |
| <p style="text-align: center;">TOP VIEW</p> <p style="text-align: center;">MSE PACKAGE 8-LEAD PLASTIC MSOP $T_{JMAX} = 150^\circ\text{C}$, $\theta_{JA} = 35^\circ\text{C/W}$ (NOTE 8) EXPOSED PAD (PIN 9) IS V^-, MUST BE SOLDERED TO PCB</p> | |

ORDER INFORMATION

| LEAD FREE FINISH | TAPE AND REEL | PART MARKING | PACKAGE DESCRIPTION | TEMPERATURE RANGE |
|-------------------|--------------------|--------------|-----------------------|-------------------|
| LTC6228IS6#TRMPBF | LTC6228IS6#TRPBF | LTHGB | 6-Lead TSOT-23 | -40°C to 85°C |
| LTC6228HS6#TRMPBF | LTC6228HS6#TRPBF | LTHGB | 6-Lead TSOT-23 | -40°C to 125°C |
| LTC6228IDC#TRMPBF | LTC6228IDC#TRPBF | LHGC | 6-Lead 2mm × 2mm DFN | -40°C to 85°C |
| LTC6228HDC#TRMPBF | LTC6228HDC#TRPBF | LHGC | 6-Lead 2mm × 2mm DFN | -40°C to 125°C |
| LTC6228IS8#TRMPBF | LTC6228IS8#TRPBF | 6228 | 8-Lead SOIC-8 | -40°C to 85°C |
| LTC6228HS8#TRMPBF | LTC6228HS8#TRPBF | 6228 | 8-Lead SOIC-8 | -40°C to 125°C |
| LTC6229IMS8E#PBF | LTC6229IMS8E#TRPBF | LTGHD | 8-Lead MSOP | -40°C to 85°C |
| LTC6229HMS8E#PBF | LTC6229HMS8E#TRPBF | LTGHD | 8-Lead MSOP | -40°C to 125°C |
| LTC6229IDD#PBF | LTC6229IDD#TRPBF | LHGF | 10-Lead 3mm × 3mm DFN | -40°C to 85°C |
| LTC6229HDD#PBF | LTC6229HDD#TRPBF | LHGF | 10-Lead 3mm × 3mm DFN | -40°C to 125°C |

Consult ADI Marketing for parts specified with wider operating temperature ranges.

[Tape and reel specifications](#). Some packages are available in 500 unit reels through designated sales channels with #TRMPBF suffix.

ELECTRICAL CHARACTERISTICS ($V_S = \pm 5V$)

The ● denotes the specifications which apply over the full operating temperature range, otherwise specifications are at $T_A = 25^\circ\text{C}$. $V_S = \pm 5V$, $V_{CM} = 0V$, V_{SHDN} = floating unless otherwise noted.

| SYMBOL | PARAMETER | CONDITIONS | MIN | TYP | MAX | UNITS |
|-----------------|--------------------------------------|----------------------------------------------|--------------|---------------|-------------|--------------------------------|
| V_{OS} | Input Offset Voltage | ● | -95 -250 | 20 | 95 250 | μV μV |
| ΔV_{OS} | Input Offset Voltage Match (LTC6229) | ● | -140 -400 | 18 | 140 400 | μV μV |
| T_{CVOS} | Input Offset Voltage Drift | ● | | 0.4 | | $\mu\text{V}/^\circ\text{C}$ |
| I_B | Input Bias Current (Note 6) | Bias Cancellation Disabled | ● | -40 -44 | -16 | μA μA |
| | | Bias Cancellation Enabled | ● | -2.5 -4.1 | 0.6 2.5 | μA μA |
| ΔI_B | Input Bias Current Match (LTC6229) | Bias Cancellation Disabled | ● | -2 -3 | 0.3 2 | μA μA |
| | | Bias Cancellation Enabled | ● | -3 -4 | 0.3 3 | μA μA |
| I_{OS} | Input Offset Current | Bias Cancellation Disabled | ● | -0.55 -0.8 | 0.1 0.55 | μA μA |
| | | Bias Cancellation Enabled | ● | -0.9 -1 | 0.1 1 | μA μA |
| ΔI_{OS} | Input Offset Current Match (LTC6229) | Bias Cancellation Disabled | ● | -1 -1.4 | 0.15 1 | μA μA |
| | | Bias Cancellation Enabled | ● | -1.3 -1.6 | 0.25 1.3 | μA μA |
| e_n | Input Noise Voltage Spectral Density | $f = 1\text{MHz}$ | | 0.88 | | $\text{nV}/\sqrt{\text{Hz}}$ |
| | Integrated 1/f Noise | 0.1Hz to 10Hz | | 0.94 | | μV_{P-P} |
| i_n | Input Current Noise Spectral Density | $f = 1\text{MHz}$ Bias Cancellation Disabled | | 3 | | $\text{pA}/\sqrt{\text{Hz}}$ |
| | | $f = 1\text{MHz}$ Bias Cancellation Enabled | | 6.3 | | $\text{pA}/\sqrt{\text{Hz}}$ |
| C_{IN} | Input Capacitance | Differential Mode | | 3.5 | | pF |
| | | Common Mode | | 1.5 | | pF |
| R_{IN} | Input Resistance | Differential Mode | | 2.6 | | $\text{k}\Omega$ |
| | | Common Mode | | 4 | | $\text{M}\Omega$ |

ELECTRICAL CHARACTERISTICS ($V_S = \pm 5V$)

The ● denotes the specifications which apply over the full operating temperature range, otherwise specifications are at $T_A = 25^\circ C$. $V_S = \pm 5V$, $V_{CM} = 0V$, $V_{SHDN} = \text{floating}$ unless otherwise noted.

| SYMBOL | PARAMETER | CONDITIONS | MIN | TYP | MAX | UNITS | |
|----------------------|------------------------------------------------------------------|---------------------------------------------------------------------------------------------|-----|-----------------------|-----------------------|------------|----|
| A _{VOL} | Large Signal Voltage Gain | R _L = 1kΩ to Half Supply V _{OUT} = ±4V | ● | 120 113 | 135 | dB dB | |
| | | R _L = 100Ω to Half Supply V _{OUT} = ±3V | ● | 100 92 | 120 | dB dB | |
| CMRR | Common Mode Rejection Ratio | V _{CM} = V ⁻ - 0.1 to V ⁺ - 1.2V | ● | 100 94 | 110 | dB dB | |
| V _{CMR} | Input Common Mode Range | | ● | V ⁻ - 0.1 | V ⁺ - 1.2 | V | |
| PSRR ⁺ | Positive Power Supply Rejection Ratio | V ⁻ = -1V, V ⁺ = 1.8V to 10.75V | ● | 100 95 | 110 | dB dB | |
| PSRR ⁻ | Negative Power Supply Rejection Ratio | V ⁺ = 1.5V, V ⁻ = -1.3V to -10.25V | ● | 101 99 | 126 | dB dB | |
| | Supply Voltage Range (V ⁺ - V ⁻) (Note 5) | | ● | 2.8 | 11.75 | V | |
| V _{OL} | Output Swing Low (V _{OUT} - V ⁻) | No Load | ● | | 8 16 20 | mV mV | |
| | | I _{SINK} = 5mA | ● | | 46 70 85 | mV mV | |
| | | I _{SINK} = 25mA | ● | | 140 220 280 | mV mV | |
| V _{OH} | Output Swing High (V ⁺ - V _{OUT}) | No Load | ● | | 27 50 60 | mV mV | |
| | | I _{SINK} = 5mA | ● | | 90 140 180 | mV mV | |
| | | I _{SOURCE} = 25mA | ● | | 250 340 450 | mV mV | |
| I _{SC} | Output Short-Circuit Current | Sourcing | ● | | -130 -80 -65 | mA mA | |
| | | Sinking | ● | 80 60 | 140 | mA mA | |
| I _S | Supply Current per Channel | | ● | | 16 16.9 19.8 | mA mA | |
| I _{SD} | Disable Supply Current per Channel, Amplifier Off | V _{SHDN} = V ⁺ - 2.75V | ● | | 500 610 770 | μA μA | |
| V _{L_SHDN} | SHDN Pin Input Voltage Low, Disable Amplifier | | ● | | V ⁺ - 2.75 | V | |
| V _{H_SHDN} | SHDN Pin Input Voltage High, Enable Amplifier | | ● | V ⁺ - 1.6 | | V | |
| V _{L_IBIAS} | SHDN Pin Input Voltage Low, Disable Bias Cancellation | | ● | | V ⁺ - 1 | V | |
| V _{H_IBIAS} | SHDN Pin Input Voltage Low, Enable Bias Cancellation | | ● | V ⁺ - 0.35 | | V | |
| I _{L_SHDN} | SHDN Pin Input Current, Disable Amplifier | V _{SHDN} = V ⁺ - 2.75V | ● | -10 | -2.5 | 10 | μA |
| I _{H_SHDN} | SHDN Pin Input Current, Enable Amplifier | V _{SHDN} = V ⁺ - 1.6V | ● | -10 | -0.3 | 10 | μA |
| I _{L_IBIAS} | SHDN Pin Input Current Low, Disable Bias Cancellation | V _{SHDN} = V ⁺ - 1V | ● | -10 | 0.265 | 10 | μA |
| I _{H_IBIAS} | SHDN Pin Input Current Low, Enable Bias Cancellation | V _{SHDN} = V ⁺ - 0.35V | ● | -10 | 1 | 10 | μA |
| I _{OSD} | Output Leakage Current in Shutdown | V _{SHDN} = V ⁺ - 2.75V, OUT Shorted to V ⁺ or V ⁻ | | | 100 | nA | |
| BW | -3dB Closed Loop Bandwidth | A _V = 1, R _L = 1kΩ to Half Supply | | | 730 | MHz | |
| GBW | Gain-Bandwidth Product | f = 5MHz, R _L = 1kΩ to Half Supply | ● | 700 650 | 890 | MHz MHz | |
| t _{ON} | Turn-On Time | V _{SHDN} = V ⁺ - 2.75V to V ⁺ - 1.6V | | | 900 | ns | |

ELECTRICAL CHARACTERISTICS ($V_S = \pm 5V$)

The ● denotes the specifications which apply over the full operating temperature range, otherwise specifications are at $T_A = 25^\circ C$. $V_S = \pm 5V$, $V_{CM} = 0V$, $V_{SHDN} = \text{floating}$ unless otherwise noted.

| SYMBOL | PARAMETER | CONDITIONS | MIN | TYP | MAX | UNITS | |
|----------------|-------------------------------------------------------------------|--------------------------------------------------|------------|-----------|-----------|--------------------------|-----|
| t_{OFF} | Turn-Off Time | $V_{SHDN} = V^+ - 1.6V$ to $V^+ - 2.75V$ | | 500 | | ns | |
| $t_{S_0.1}$ | Settling Time to 0.1% | $A_V = 1$, 2V Output Step, $R_L = 1k\Omega$ | | 26 | | ns | |
| | | $A_V = 1$, 4V Output Step, $R_L = 1k\Omega$ | | 34 | | ns | |
| $t_{S_0.01}$ | Settling Time to 0.01% | $A_V = 1$, 6V Output Step, $R_L = 1k\Omega$ | | 53 | | ns | |
| SR | Slew Rate | $A_V = +4$, 8V Output Step (Note 8) | 320 250 | 500 | | V/ μs V/ μs | |
| FPBW | Full Power Bandwidth | $V_{OUT} = 8V_{P-P}$, $A_V = +2$, THD < -40dBc | | 12.5 | | MHz | |
| HD2/HD3 | Harmonic Distortion, $R_L = 1k\Omega$ to Half Supply, $A_V = +1$ | $f_C = 100kHz$, $V_O = 4V_{P-P}$ | | -113/-119 | | dBc | |
| | | $f_C = 100kHz$, $V_O = 2V_{P-P}$ | | -126/-131 | | dBc | |
| | | $f_C = 1MHz$, $V_O = 4V_{P-P}$ | | -107/-114 | | dBc | |
| | | $f_C = 1MHz$, $V_O = 2V_{P-P}$ | | -119/-132 | | dBc | |
| | | $f_C = 5MHz$, $V_O = 4V_{P-P}$ | | -83/-96 | | dBc | |
| | | $f_C = 5MHz$, $V_O = 2V_{P-P}$ | | -90/-113 | | dBc | |
| | Harmonic Distortion, $R_L = 100\Omega$ to Half Supply, $A_V = +1$ | $f_C = 100kHz$, $V_O = 4V_{P-P}$ | | | -105/-106 | | dBc |
| | | $f_C = 100kHz$, $V_O = 4V_{P-P}$ | | | -118/-124 | | dBc |
| | | $f_C = 1MHz$, $V_O = 4V_{P-P}$ | | | -97/-107 | | dBc |
| | | $f_C = 1MHz$, $V_O = 2V_{P-P}$ | | | -100/-114 | | dBc |
| | | $f_C = 5MHz$, $V_O = 4V_{P-P}$ | | | -79/-75 | | dBc |
| | | $f_C = 5MHz$, $V_O = 2V_{P-P}$ | | | -83/-82 | | dBc |
| ΔG | Differential Gain (NTSC) | $A_V = 2$, $R_L = 150\Omega$ | | 0.008 | | % | |
| | | $A_V = +1$, $R_L = 1k\Omega$ | | 0.001 | | % | |
| $\Delta\theta$ | Differential Phase (NTSC) | $A_V = 2$, $R_L = 150\Omega$ | | 0.004 | | Deg | |
| | | $A_V = +1$, $R_L = 1k\Omega$ | | 0.09 | | Deg | |

ELECTRICAL CHARACTERISTICS ($V_S = 5V, 0V$)

The ● denotes the specifications which apply over the full operating temperature range, otherwise specifications are at $T_A = 25^\circ C$. $V_S = 5V, 0V$, $V_{CM} = V_{OUT} = 2.5V$, $V_{SHDN} = \text{floating}$ unless otherwise noted.

| SYMBOL | PARAMETER | CONDITIONS | MIN | TYP | MAX | UNITS |
|-----------------|--------------------------------------|----------------------------|-------|------|------|------------------|
| V_{OS} | Input Offset Voltage | | -105 | 20 | 105 | μV |
| | | | -290 | | 290 | μV |
| ΔV_{OS} | Input Offset Voltage Match (LTC6229) | | -140 | 18 | 140 | μV |
| | | | -400 | | 400 | μV |
| T_{CVOS} | Input Offset Voltage Drift | | | 0.4 | | $\mu V/^\circ C$ |
| I_B | Input Bias Current (Note 6) | Bias Cancellation Disabled | -40 | -16 | | μA |
| | | | -44 | | | μA |
| ΔI_B | Input Bias Current Match (LTC6229) | Bias Cancellation Enabled | -3 | 1 | 3 | μA |
| | | | -4.4 | | 4.4 | μA |
| ΔI_B | Input Bias Current Match (LTC6229) | Bias Cancellation Disabled | -2 | 0.3 | 2 | μA |
| | | | -3 | | 3 | μA |
| I_{OS} | Input Offset Current | Bias Cancellation Disabled | -0.55 | 0.1 | 0.55 | μA |
| | | | -0.8 | | 0.8 | μA |
| ΔI_{OS} | Input Offset Current Match (LTC6229) | Bias Cancellation Enabled | -0.9 | 0.15 | 0.9 | μA |
| | | | -1 | | 1 | μA |
| ΔI_{OS} | Input Offset Current Match (LTC6229) | Bias Cancellation Disabled | -1 | 0.15 | 1 | μA |
| | | | -1.4 | | 1.4 | μA |
| ΔI_{OS} | Input Offset Current Match (LTC6229) | Bias Cancellation Enabled | -1.3 | 0.25 | 1.3 | μA |
| | | | -1.6 | | 1.6 | μA |

ELECTRICAL CHARACTERISTICS (V_S = 5V, 0V) The ● denotes the specifications which apply over the full operating temperature range, otherwise specifications are at T_A = 25°C. V_S = 5V, 0V, V_{CM} = V_{OUT} = 2.5V, V_{SHDN} = floating unless otherwise noted.

| SYMBOL | PARAMETER | CONDITIONS | MIN | TYP | MAX | UNITS | |
|----------------------|-------------------------------------------------------|-----------------------------------------------------------------------------|-----|-----------------------|-----------------------|-------------------|----|
| e _n | Input Noise Voltage Spectral Density | f = 1MHz | | 0.88 | | nV/√Hz | |
| | Integrated 1/f Noise | 0.1Hz to 10Hz | | 0.94 | | μV _{P-P} | |
| i _n | Input Current Noise Spectral Density | f = 1MHz Bias Cancellation Disabled | | 3 | | pA/√Hz | |
| | | f = 1MHz Bias Cancellation Enabled | | 6.3 | | pA/√Hz | |
| C _{IN} | Input Capacitance | Differential Mode | | 3.5 | | pF | |
| | | Common Mode | | 1.5 | | pF | |
| R _{IN} | Input Resistance | Differential Mode | | 2.6 | | kΩ | |
| | | Common Mode | | 4 | | MΩ | |
| A _{VOL} | Large Signal Voltage Gain | R _L = 1kΩ to Half Supply, V _{OUT} = V _{CM} ±2 | ● | 120 115 | 140 | dB dB | |
| | | R _L = 100Ω to Half Supply, V _{OUT} = V _{CM} ±2 | ● | 106 100 | 120 | dB dB | |
| CMRR | Common Mode Rejection Ratio | V _{CM} = V ⁻ - 0.1 to V ⁺ - 1.2V | ● | 97 92 | 110 | dB dB | |
| V _{CMR} | Input Common Mode Range | | ● | V ⁻ - 0.1 | V ⁺ - 1.2 | V | |
| PSRR ⁺ | Positive Power Supply Rejection Ratio | V ⁻ = -1V, V ⁺ = 1.8V to 10.75V | ● | 100 95 | 110 | dB dB | |
| PSRR ⁻ | Negative Power Supply Rejection Ratio | V ⁺ = 1.5V, V ⁻ = -1.3V to -10.25V | ● | 103 100 | 126 | dB dB | |
| | | Supply Voltage Range (V ⁺ - V ⁻) (Note 5) | ● | 2.8 | 11.75 | V | |
| V _{OL} | Output Swing Low (V _{OUT} - V ⁻) | No Load | ● | 7 | 18 32 | mV mV | |
| | | I _{SINK} = 5mA | ● | 40 | 70 90 | mV mV | |
| | | I _{SINK} = 25mA | ● | 150 | 220 300 | mV mV | |
| V _{OH} | Output Swing High (V _{CC} - V ⁺) | No Load | ● | 26 | 48 58 | mV mV | |
| | | I _{SINK} = 5mA | ● | 93 | 144 185 | mV mV | |
| | | I _{SOURCE} = 25mA | ● | 255 | 347 459 | mV mV | |
| I _{SC} | Output Short-Circuit Current | Sourcing | ● | -110 | -65 -52 | mA mA | |
| | | Sinking | ● | 70 45 | 110 | mA mA | |
| I _S | Supply Current per Channel | | ● | 16.5 | 17.8 19.6 | mA mA | |
| I _{SD} | Disable Supply Current per Channel, Amplifier Off | V _{SHDN} = V ⁺ - 2.65V | ● | 300 | 380 430 | μA μA | |
| V _{L_SHDN} | SHDN Pin Input Voltage Low, Disable Amplifier | | ● | | V ⁺ - 2.65 | V | |
| V _{H_SHDN} | SHDN Pin Input Voltage High, Enable Amplifier | | ● | V ⁺ - 1.6 | | V | |
| V _{L_IBIAS} | SHDN Pin Input Voltage Low, Disable Bias Cancellation | | ● | | V ⁺ - 1 | V | |
| V _{H_IBIAS} | SHDN Pin Input Voltage Low, Enable Bias Cancellation | | ● | V ⁺ - 0.35 | | V | |
| I _{L_SHDN} | SHDN Pin Input Current, Disable Amplifier | V _{SHDN} = V ⁺ - 2.65V | ● | -10 | -2.5 | 10 | μA |

ELECTRICAL CHARACTERISTICS ($V_S = 5V, 0V$) The ● denotes the specifications which apply over the full operating temperature range, otherwise specifications are at $T_A = 25^\circ\text{C}$. $V_S = 5V, 0V, V_{CM} = V_{OUT} = 2.5V, V_{SHDN} = \text{floating}$ unless otherwise noted.

| SYMBOL | PARAMETER | CONDITIONS | MIN | TYP | MAX | UNITS |
|----------------|-------------------------------------------------------|-------------------------------------------------------------------------------------------------------------------------------------------------------------|--------------|----------------------------------------------|-----|--------------------------|
| I_{H_SHDN} | SHDN Pin Input Current, Enable Amplifier | $V_{SHDN} = V^+ - 1.6V$ | ● -10 | -0.3 | 10 | μA |
| I_{L_BIAS} | SHDN Pin Input Current Low, Disable Bias Cancellation | $V_{SHDN} = V^+ - 1V$ | ● -10 | 0.265 | 10 | μA |
| I_{H_BIAS} | SHDN Pin Input Current Low, Enable Bias Cancellation | $V_{SHDN} = V^+ - 0.35V$ | ● -10 | 1 | 10 | μA |
| I_{OSD} | Output Leakage Current in Shutdown | $V_{SHDN} = V^+ - 2.65V$, OUT Shorted to V^+ or V^- | | 100 | | nA |
| BW | -3dB Closed Loop Bandwidth | $A_V = 1, R_L = 1k\Omega$ to Half Supply | | 800 | | MHz |
| GBW | Gain-Bandwidth Product | $f = 5\text{MHz}, R_L = 1k\Omega$ to Half Supply | ● 700 600 | 865 | | MHz MHz |
| t_{ON} | Turn-On Time | $V_{SHDN} = V^+ - 2.65V$ to $V^+ - 1.6V$ | | 900 | | ns |
| t_{OFF} | Turn-Off Time | $V_{SHDN} = V^+ - 1.6V$ to $V^+ - 2.65V$ | | 500 | | ns |
| $t_{S\ 0.1}$ | Settling Time to 0.1% | $A_V = 1, 2V$ Output Step, $R_L = 1k\Omega$ | | 26 | | ns |
| SR | Slew Rate | $A_V = +4, 4V$ Output Step (Note 8) | | 350 | | V/ μs |
| FPBW | Full Power Bandwidth | $V_{OUT} = 4V_{P-P}, A_V = +2, THD < -40\text{dBc}$ | | 18 | | MHz |
| HD2/HD3 | Harmonic Distortion, $R_L = 1k\Omega$ to Half Supply | $f_C = 100\text{kHz}, V_O = 2V_{P-P}$ $f_C = 1\text{MHz}, V_O = 2V_{P-P}$ $f_C = 5\text{MHz}, V_O = 2V_{P-P}$ $f_C = 10\text{MHz}, V_O = 2V_{P-P}$ | | -106/-130 -95/-105 -88/-114 -78/-90 | | dBc dBc dBc dBc |
| | Harmonic Distortion, $R_L = 100\Omega$ to Half Supply | $f_C = 100\text{kHz}, V_O = 2V_{P-P}$ $f_C = 1\text{MHz}, V_O = 2V_{P-P}$ $f_C = 5\text{MHz}, V_O = 2V_{P-P}$ $f_C = 10\text{MHz}, V_O = 2V_{P-P}$ | | -112/-115 -99/-120 -83/-88 -70/-73 | | dBc dBc dBc dBc |
| ΔG | Differential Gain (NTSC) | $A_V = 2, R_L = 150\Omega$ | | 0.005 | | % |
| | | $A_V = +1, R_L = 1k\Omega$ | | 0.002 | | % |
| $\Delta\theta$ | Differential Phase (NTSC) | $A_V = 2, R_L = 150\Omega$ | | 0.007 | | Deg |
| | | $A_V = +1, R_L = 1k\Omega$ | | 0.018 | | Deg |

ELECTRICAL CHARACTERISTICS ($V_S = 3V, 0V$) The ● denotes the specifications which apply over the full operating temperature range, otherwise specifications are at $T_A = 25^\circ\text{C}$. $V_S = 3V, 0V, V_{CM} = 1.5V, V_{SHDN} = \text{floating}$ unless otherwise noted.

| SYMBOL | PARAMETER | CONDITIONS | MIN | TYP | MAX | UNITS |
|--------------|------------------------------------|----------------------------|----------------|-----|------------|--------------------------------|
| V_{OS} | Input Offset Voltage | | ● -110 -300 | 24 | 110 300 | μV μV |
| | | ΔV_{OS} | ● -140 -400 | 18 | 140 400 | μV μV |
| T_{CVOS} | Input Offset Voltage Drift | | ● | 0.4 | | $\mu\text{V}/^\circ\text{C}$ |
| I_B | Input Bias Current (Note 6) | Bias Cancellation Disabled | ● -38 -44 | -16 | | μA μA |
| | | Bias Cancellation Enabled | ● -3.5 -4.3 | 1.5 | 3.5 4.1 | μA μA |
| ΔI_B | Input Bias Current Match (LTC6229) | Bias Cancellation Disabled | ● -2 -3 | 0.3 | 2 3 | μA μA |
| | | Bias Cancellation Enabled | ● -3 -4 | 0.3 | 3 4 | μA μA |

ELECTRICAL CHARACTERISTICS ($V_S = 3V, 0V$)

The ● denotes the specifications which apply over the full operating temperature range, otherwise specifications are at $T_A = 25^\circ C$. $V_S = 3V, 0V, V_{CM} = 1.5V, V_{SHDN}$ = floating unless otherwise noted.

| SYMBOL | PARAMETER | CONDITIONS | MIN | TYP | MAX | UNITS |
|-------------------|---------------------------------------------------|--------------------------------------------------------------------|--------------------|------|-------------|--------------------|
| I_{OS} | Input Offset Current | Bias Cancellation Disabled | ● -0.55 -0.8 | 0.1 | 0.55 0.8 | μA μA |
| | | Bias Cancellation Enabled | ● -0.9 -1 | 0.15 | 0.9 1 | μA μA |
| ΔI_{OS} | Input Offset Current Match (LTC6229) | Bias Cancellation Disabled | ● -1 -1.4 | 0.15 | 1 1.4 | μA μA |
| | | Bias Cancellation Enabled | ● -1.3 -1.6 | 0.25 | 1.3 1.6 | μA μA |
| e_n | Input Noise Voltage Spectral Density | $f = 1MHz$ | | 0.88 | | nV/\sqrt{Hz} |
| | Integrated 1/f Noise | 0.1Hz to 10Hz | | 0.94 | | μV_{P-P} |
| i_n | Input Current Noise Spectral Density | $f = 1MHz$ Bias Cancellation Disabled | | 3 | | pA/\sqrt{Hz} |
| | | $f = 1MHz$ Bias Cancellation Enabled | | 6.3 | | pA/\sqrt{Hz} |
| C_{IN} | Input Capacitance | Differential Mode | | 3.5 | | pF |
| | | Common Mode | | 1.5 | | pF |
| R_{IN} | Input Resistance | Differential Mode | | 2.6 | | $k\Omega$ |
| | | Common Mode | | 4 | | $M\Omega$ |
| A_{VOL} | Large Signal Voltage Gain | $R_L = 1k\Omega$ to Half Supply, ($V_{OUT} = V_{CM} \pm 1V$) | ● 118 113 | 130 | | dB dB |
| | | $R_L = 100\Omega$ to Half Supply, ($V_{OUT} = V_{CM} \pm 1V$) | | 120 | | dB |
| CMRR | Common Mode Rejection Ratio | $V_{CM} = V^-$ to $V^+ - 1.2V$ | ● 95 91 | 110 | | dB dB |
| V_{CMR} | Input Common Mode Range | | ● $V^- - 0.1$ | | $V^+ - 1.2$ | V |
| PSRR ⁺ | Positive Power Supply Rejection Ratio | $V^- = -1V, V^+ = 1.8V$ to $10.75V$ | ● 100 95 | 110 | | dB dB |
| PSRR ⁻ | Negative Power Supply Rejection Ratio | $V^+ = 1.5V, V^- = -1.3V$ to $-10.25V$ | ● 101 99 | 126 | | dB dB |
| | Supply Voltage Range ($V^+ - V^-$) (Note 5) | | ● 2.8 | | 11.75 | V |
| V_{OL} | Output Swing Low ($V_{OUT} - V^-$) | No Load | ● ● | 7 | 10 18 | mV mV |
| | | $I_{SINK} = 5mA$ | ● | 48 | 74 100 | mV mV |
| | | $I_{SINK} = 25mA$ | ● | 165 | 320 430 | mV mV |
| V_{OH} | Output Swing High ($V_{CC} - V^+$) | No Load | ● ● | 27 | 49 59 | mV mV |
| | | $I_{SINK} = 5mA$ | ● | 106 | 166 213 | mV mV |
| | | $I_{SOURCE} = 25mA$ | ● | 290 | 520 580 | mV mV |
| I_{SC} | Output Short-Circuit Current | Sourcing | | -67 | | mA |
| | | Sinking | | 84 | | mA |
| I_S | Supply Current per Channel | | ● | 16.4 | 17.6 19 | mA mA |
| I_{SD} | Disable Supply Current per Channel, Amplifier Off | $V_{SHDN} = V^+ - 2.65V$ | ● | 260 | 305 350 | μA μA |

ELECTRICAL CHARACTERISTICS ($V_S = 3V, 0V$) The ● denotes the specifications which apply over the full operating temperature range, otherwise specifications are at $T_A = 25^\circ\text{C}$. $V_S = 3V, 0V, V_{CM} = 1.5V$, V_{SHDN} = floating unless otherwise noted.

| SYMBOL | PARAMETER | CONDITIONS | MIN | TYP | MAX | UNITS | |
|----------------|----------------------------------------------------------------------------------------------|---------------------------------------------------------------------------------------------|-----|--------------|-----------------------------------------------|-------|--------------------------|
| V_{L_SHDN} | SHDN Pin Input Voltage Low, Disable Amplifier | | ● | | $V^+ - 2.65$ | V | |
| V_{H_SHDN} | SHDN Pin Input Voltage High, Enable Amplifier | | ● | $V^+ - 1.6$ | | V | |
| V_{L_IBIAS} | SHDN Pin Input Voltage Low, Disable Bias Cancellation | | ● | | $V^+ - 1$ | V | |
| V_{H_IBIAS} | SHDN Pin Input Voltage Low, Enable Bias Cancellation | | ● | $V^+ - 0.35$ | | V | |
| I_{L_SHDN} | SHDN Pin Input Current, Disable Amplifier | $V_{SHDN} = V^+ - 2.65V$ | ● | -10 | -2.5 | 10 | μA |
| I_{H_SHDN} | SHDN Pin Input Current, Enable Amplifier | $V_{SHDN} = V^+ - 1.6V$ | ● | -10 | -0.3 | 10 | μA |
| I_{L_IBIAS} | SHDN Pin Input Current Low, Disable Bias Cancellation | $V_{SHDN} = V^+ - 1V$ | ● | -10 | 0.265 | 10 | μA |
| I_{H_IBIAS} | SHDN Pin Input Current Low, Enable Bias Cancellation | $V_{SHDN} = V^+ - 0.35V$ | ● | -10 | 1 | 10 | μA |
| I_{OSD} | Output Leakage Current in Shutdown | $V_{SHDN} = V^+ - 2.65V$, OUT Shorted to V^+ or V^- | | | 100 | | nA |
| BW | -3dB Closed Loop Bandwidth | $A_V = 1$, $R_L = 1k\Omega$ to Half Supply | | | 763 | | MHz |
| GBW | Gain-Bandwidth Product | $f = 5\text{MHz}$, $R_L = 1k\Omega$ to Half Supply | ● | 700 560 | 845 | | MHz MHz |
| t_{ON} | Turn-On Time | $V_{SHDN} = V^+ - 2.65V$ to $V^+ - 1.6V$ | | | 900 | | ns |
| t_{OFF} | Turn-Off Time | $V_{SHDN} = V^+ - 1.6V$ to $V^+ - 2.65V$ | | | 500 | | ns |
| $t_{S,0.1}$ | Settling Time to 0.1% | $A_V = 1$, $V_{CM} = 1V$, 1V Output Step, $R_L = 1k\Omega$ | | | 31 | | ns |
| SR | Slew Rate | $A_V = +4$, 2V Output Step | | | 200 | | V/ μs |
| FPBW | Full Power Bandwidth | $V_{OUT} = 2V_{P-P}$, $V_{CM} = 1V$, $A_V = -1$, THD < -40dBc | | | 22 | | MHz |
| HD2/HD3 | Harmonic Distortion, $R_L = 1k\Omega$ to V_{CM} , $V_{OUT} = 1V_{P-P}$, $V_{CM} = 1.25V$ | $f_C = 100\text{kHz}$ $f_C = 1\text{MHz}$ $f_C = 5\text{MHz}$ $f_C = 10\text{MHz}$ | | | -106/-127 -110/-128 -82/-105 -77/-96 | | dBc dBc dBc dBc |
| | Harmonic Distortion, $R_L = 100\Omega$ to V_{CM} , $V_{OUT} = 1V_{P-P}$, $V_{CM} = 1.25V$ | $f_C = 100\text{kHz}$ $f_C = 1\text{MHz}$ $f_C = 5\text{MHz}$ $f_C = 10\text{MHz}$ | | | -116/-123 -105/-132 -89/-98 -77/-86 | | dBc dBc dBc dBc |

Note 1: Stresses beyond those listed under Absolute Maximum Ratings may cause permanent damage to the device. Exposure to any Absolute Maximum Rating condition for extended periods may affect device reliability and lifetime.

Note 2: The inputs are protected by back-to-back diodes. If any of the input or shutdown pins goes 300mV beyond either supply or the differential input voltage exceeds 0.7V, the input current should be limited to less than 10mA.

Note 3: A heat sink may be required to keep the junction temperature below the absolute maximum rating when the output current is high.

Note 4: The LTC6228/LTC6229 is guaranteed functional and specified over the temperature range of -40°C to 85°C . The LTC6228H/LTC6229H is guaranteed functional and specified over the temperature range of -40°C to 125°C .

Note 5: Supply range voltage is guaranteed by power supply rejection ratio test.

Note 6: The input bias current is the average of the currents through the non-inverting and inverting input pins.

Note 7: Thermal resistance varies with the amount of PC board metal connected to the package. The specified values are with short traces connected to the leads with minimal metal area.

Note 8: Middle 2/3 of the output waveform is observed. $R_L = 1k\Omega$ at half supply.

TYPICAL PERFORMANCE CHARACTERISTICS $V_S = \pm 5V$, $V_{CM} = 0V$, $T_A = 25^\circ C$, unless otherwise noted.

Offset Distribution

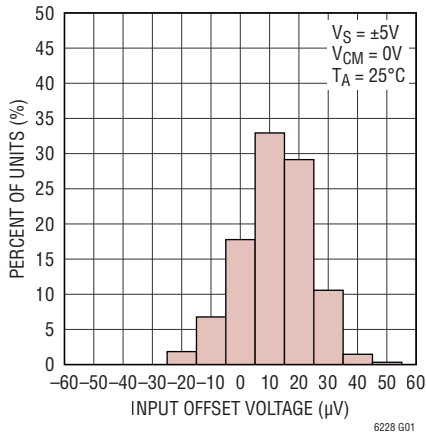

Offset Distribution

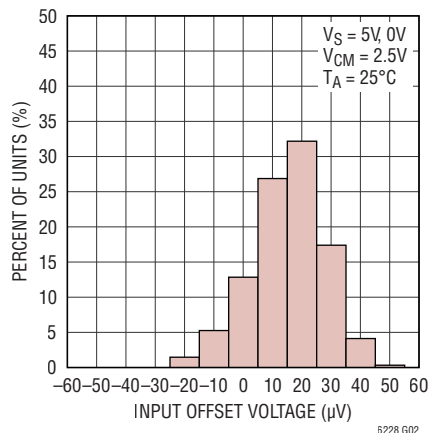

Offset Distribution

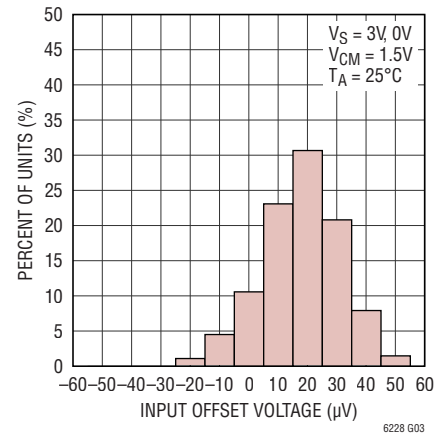

V_{OS} vs Temperature, 10V Supply

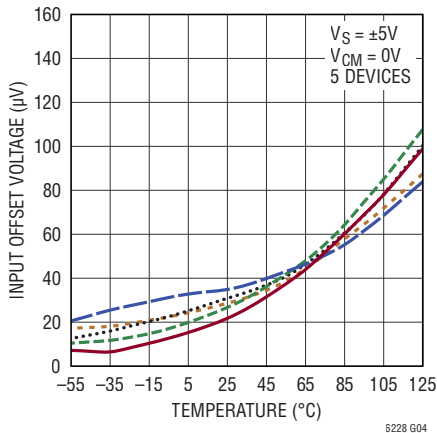

V_{OS} vs Temperature, 5V Supply

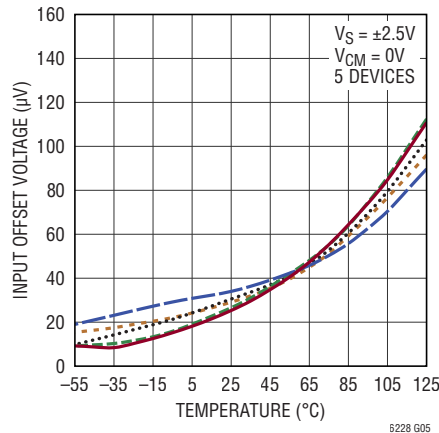

V_{OS} vs Temperature, 3V Supply

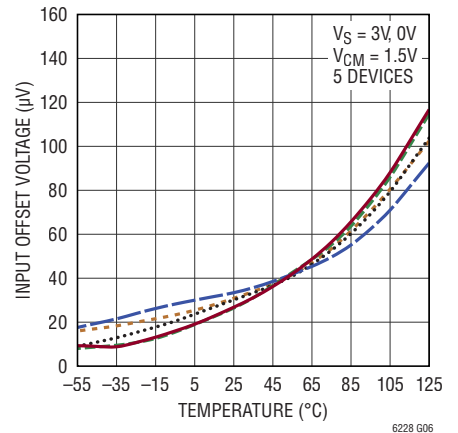

Offset Voltage vs Input Common Mode Voltage

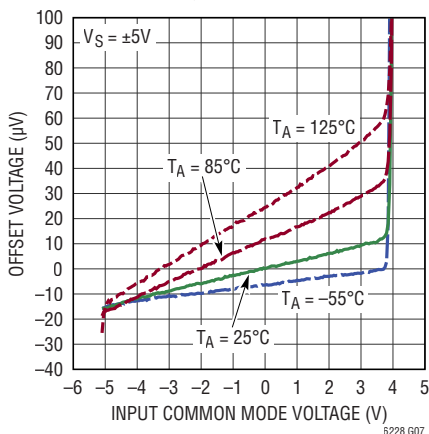

Offset Voltage vs Output Current

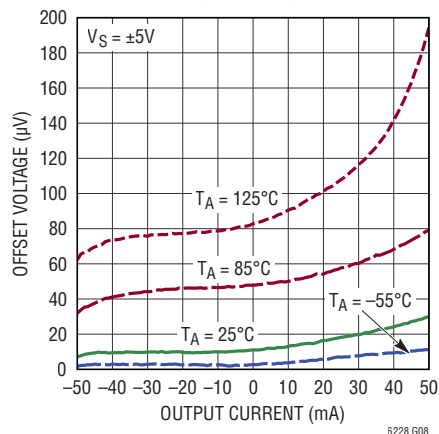

Warm Up Drift vs Time

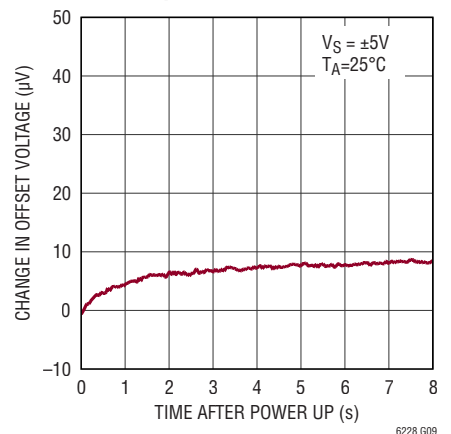

TYPICAL PERFORMANCE CHARACTERISTICS $V_S = \pm 5V$, $V_{CM} = 0V$, $T_A = 25^\circ C$, unless otherwise noted.

Input Bias Current vs Input Common Voltage, Bias Cancellation Disabled

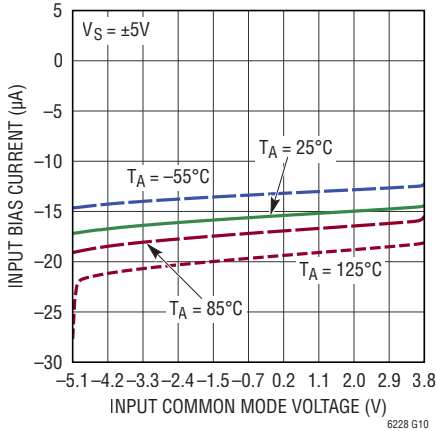

Input Bias Current vs Input Common Mode Voltage, Bias Cancellation Enabled

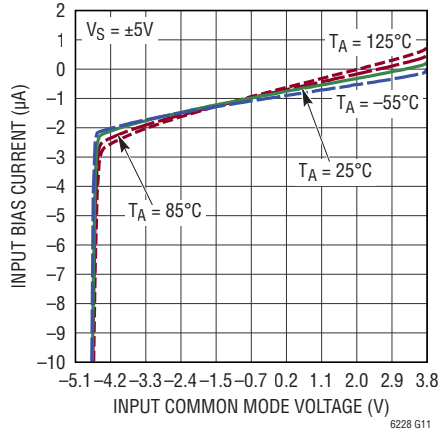

0.1Hz to 10Hz Voltage Noise

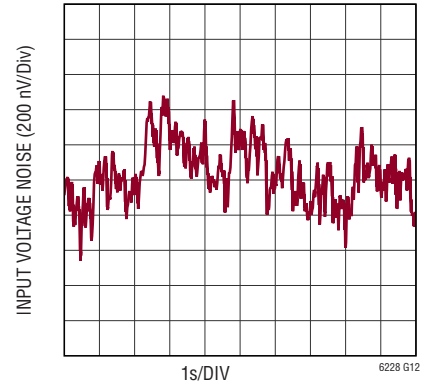

Input Voltage Noise and Current Noise Spectral Densities vs Frequency

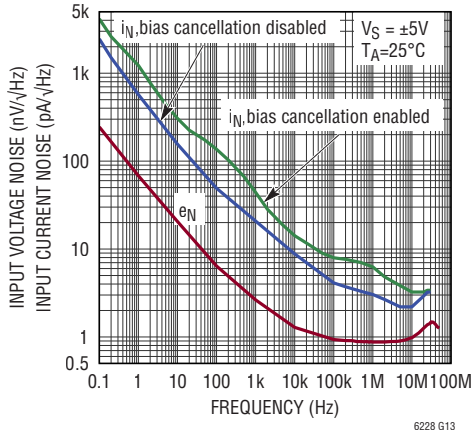

Supply Current vs Supply Voltage

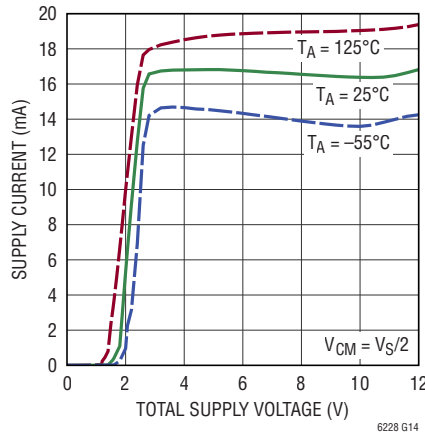

Supply Current vs Input Common Mode Voltage

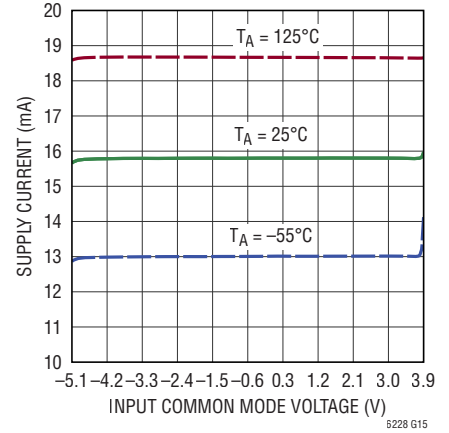

Supply Current vs SHDN Pin Voltage

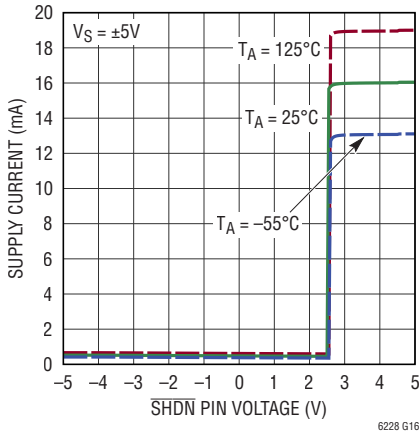

Input Bias Current vs SHDN Pin Voltage

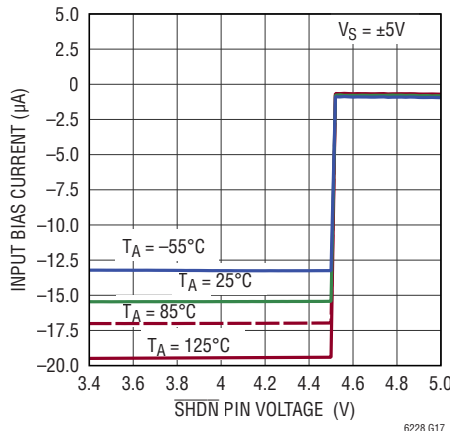

SHDN Pin Current vs SHDN Pin Voltage

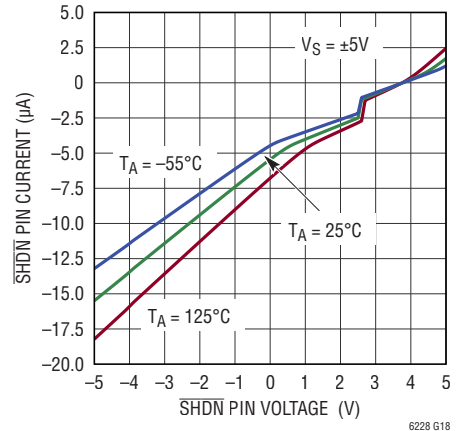

TYPICAL PERFORMANCE CHARACTERISTICS $V_S = \pm 5V$, $V_{CM} = 0V$, $T_A = 25^\circ C$, unless otherwise noted.

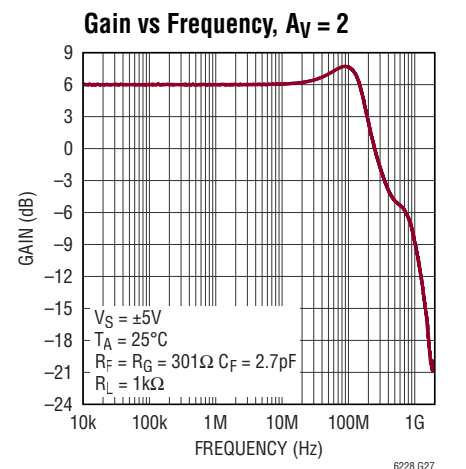
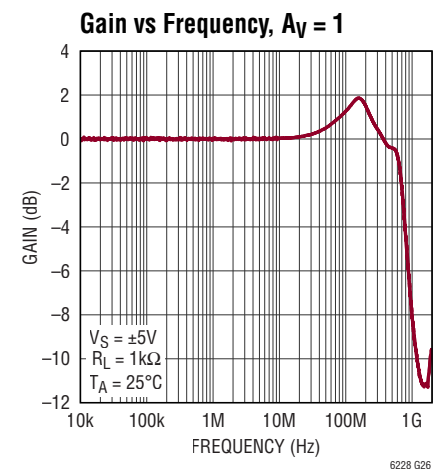
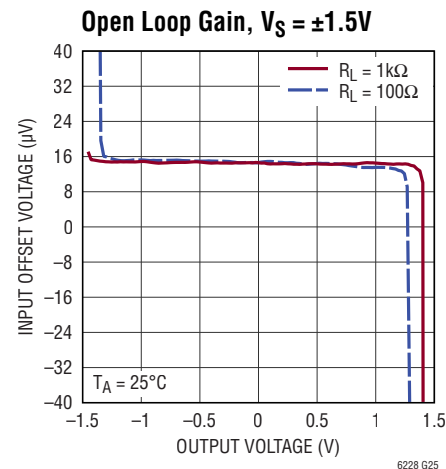
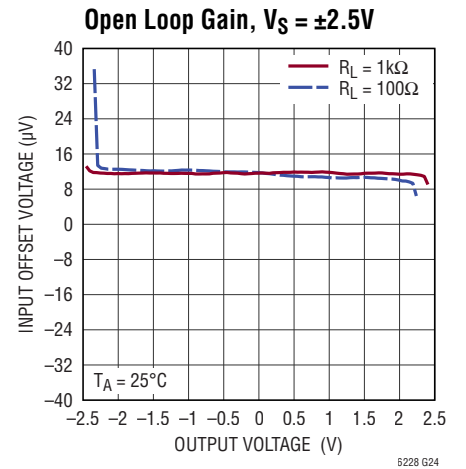
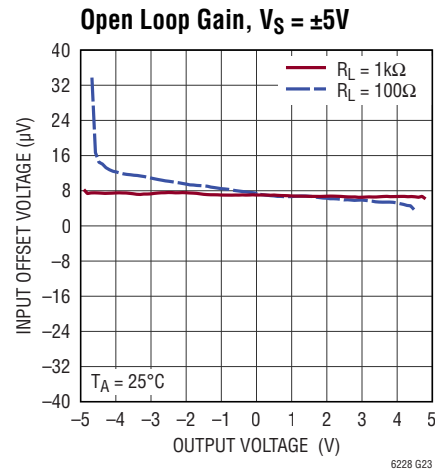
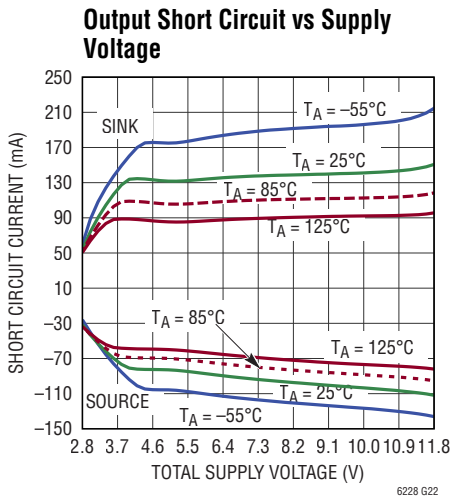
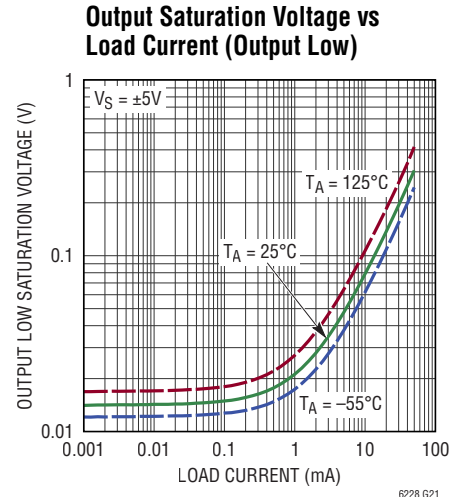
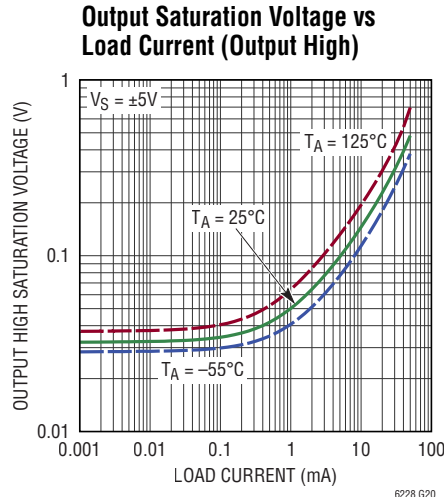
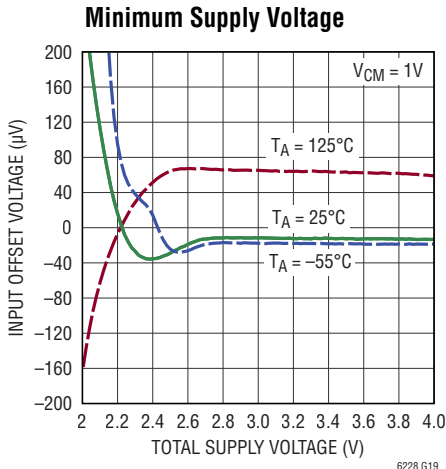

TYPICAL PERFORMANCE CHARACTERISTICS $V_S = \pm 5V$, $V_{CM} = 0V$, $T_A = 25^\circ C$, unless otherwise noted.

Open Loop Gain and Phase vs Frequency

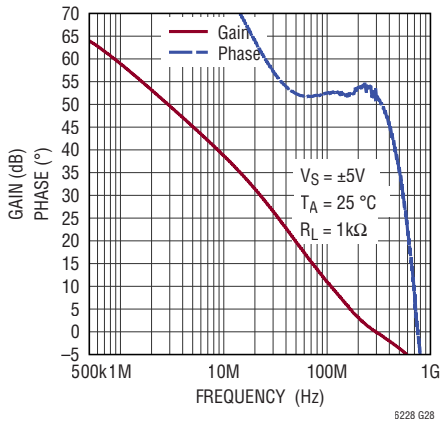

Gain Bandwidth and Phase Margin vs Supply Voltage

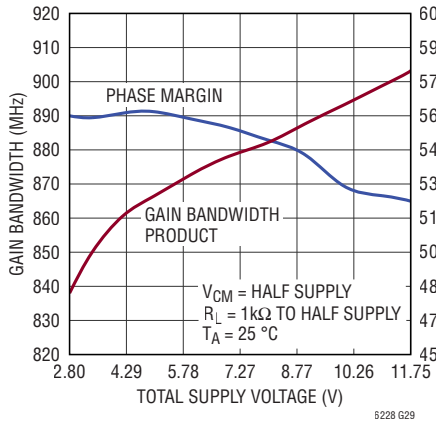

Gain Bandwidth and Phase Margin vs Temperature

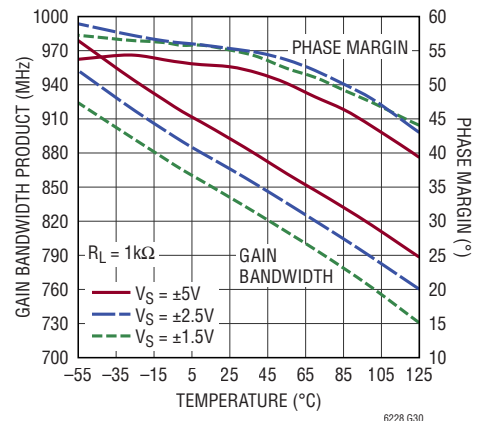

Output Impedance vs Frequency

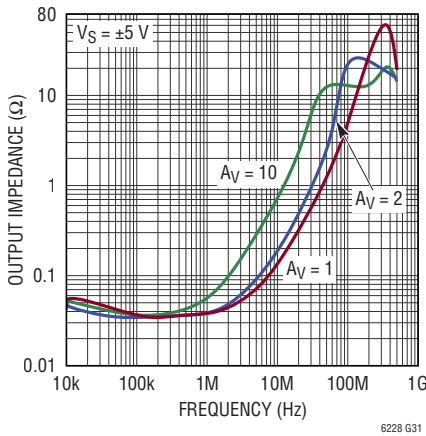

Common Mode Rejection Ratio vs Frequency

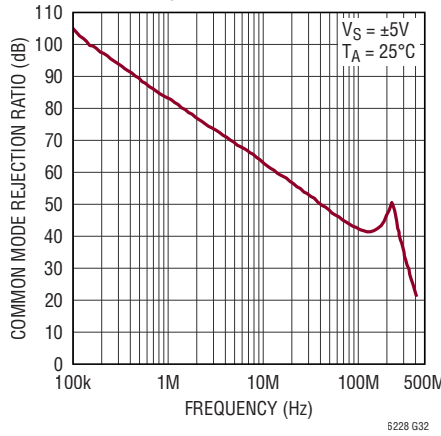

Power Supply Rejection Ratio vs Frequency

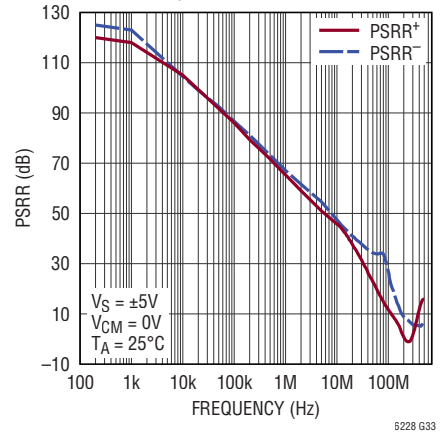

Slew Rate vs Temperature

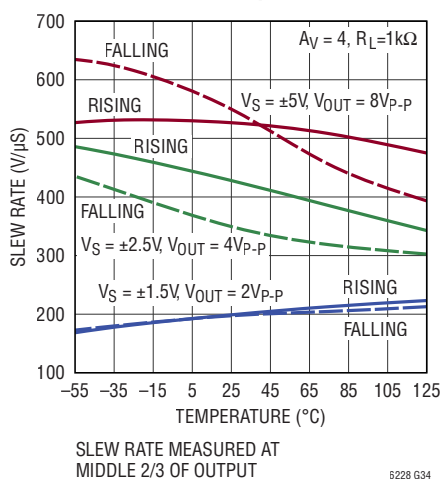

Series Output Resistor vs Capacitive Load, $A_V = 1$

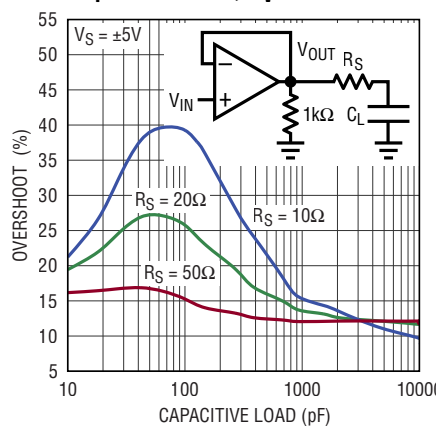

Series Output Resistor vs Capacitive Load, $A_V = 2$

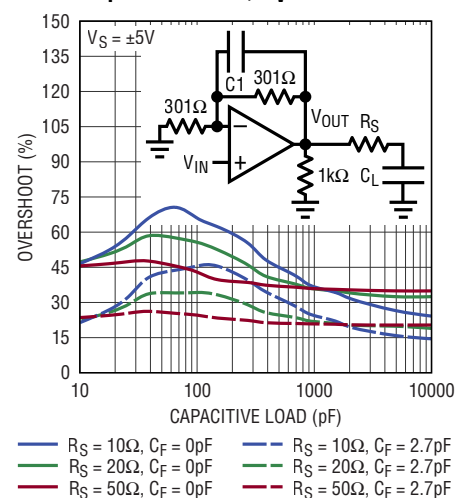

TYPICAL PERFORMANCE CHARACTERISTICS $V_S = \pm 5V$, $V_{CM} = 0V$, $T_A = 25^\circ C$, unless otherwise noted.

Distortion vs Frequency, $A_V = 1$, $\pm 5V$ Supply

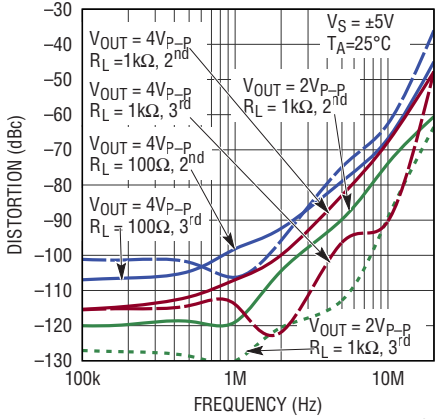

Distortion vs Frequency, $A_V = 1$, 5V Supply

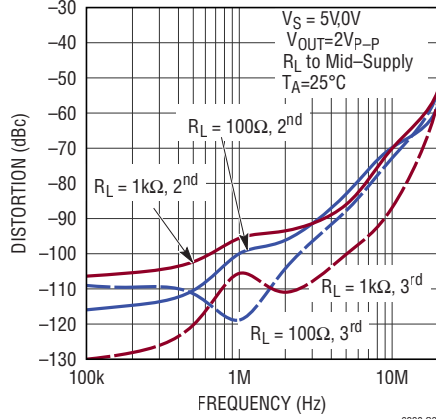

Distortion vs Frequency, $A_V = 1$, 3V Supply

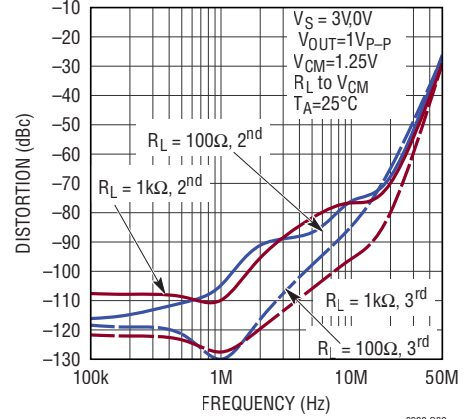

Distortion vs Frequency, $A_V = 2$, $\pm 5V$ Supply

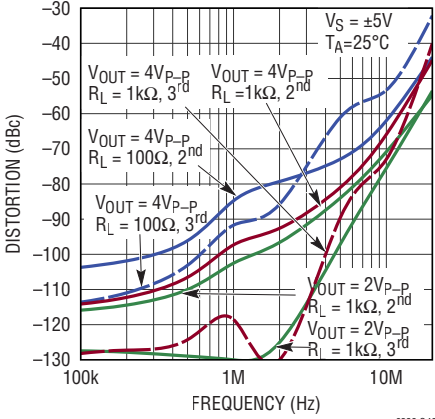

Distortion vs Frequency, $A_V = 2$, 5V Supply

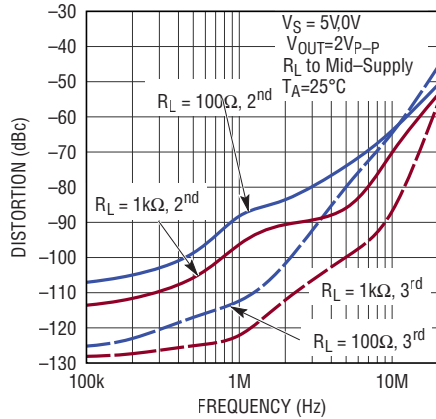

Distortion vs Frequency, $A_V = 2$, 3V Supply

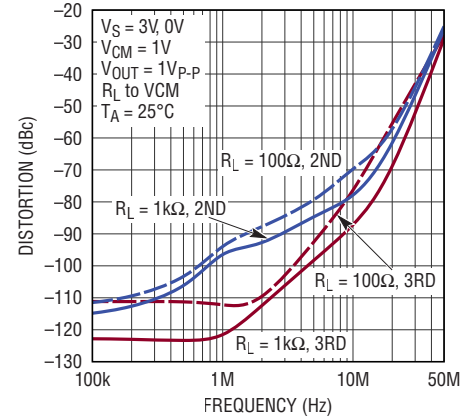

Maximum Undistorted Output Signal vs Frequency

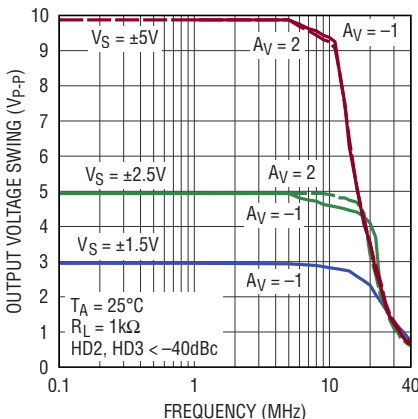

0.1% Settling Time vs Output Step (Non-Inverting)

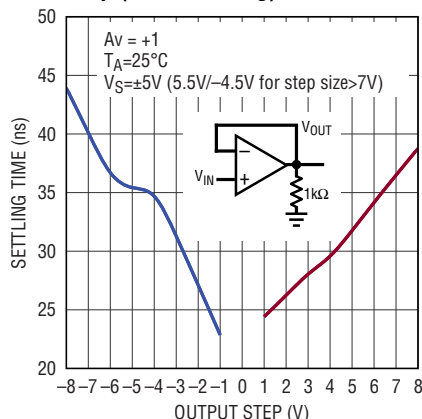

0.1% Settling Time vs Output Step (Inverting)

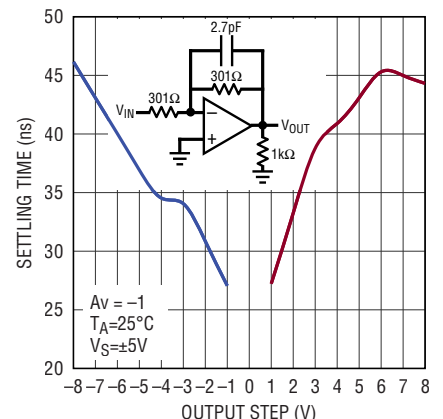

TYPICAL PERFORMANCE CHARACTERISTICS $V_S = \pm 5V$, $V_{CM} = 0V$, $T_A = 25^\circ C$, unless otherwise noted.

SHDN Pin Response Time

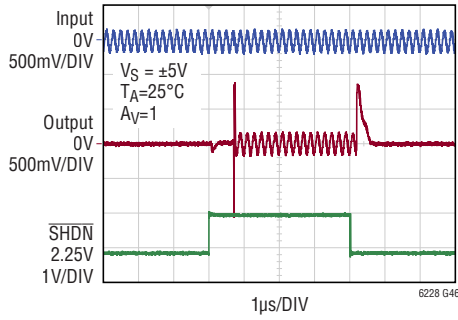

Large Signal Response

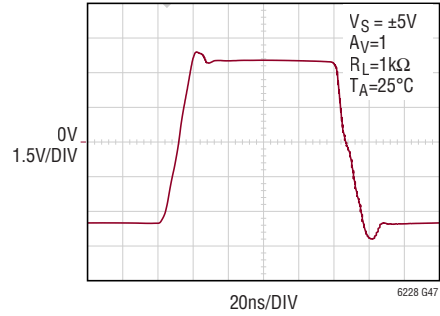

Small Signal Response

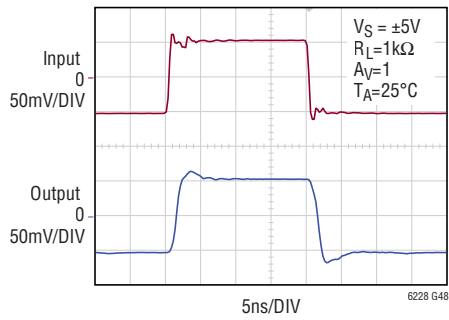

Output Overdrive Recovery

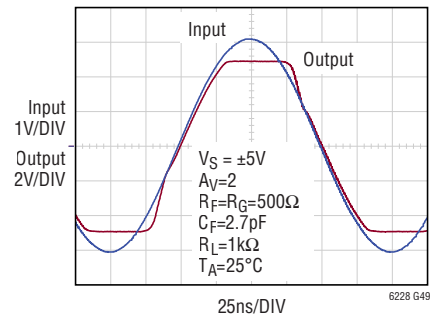

PIN FUNCTIONS

FB (SOIC-8 Only): Feedback Pin. Internally connected to OUT.

+IN: Non-Inverting Input of Amplifier. Valid input range is from V^- to $V^+ - 1.2V$

-IN: Inverting Input of Amplifier. Valid input range is from V^- to $V^+ - 1.2V$

OUT: Output of the Amplifier. Swings rail to rail and can typically source/sink more than 90mA of current.

$\overline{\text{SHDN}}$: Shutdown Pin (Active Low). Referenced to V^+ . When taken 2.75V below V^+ , the amplifier shuts down and enters low power mode, with the outputs in a high impedance state. When taken to within 350mV of V^+ , bias current cancellation is enabled. When left floating, the amplifier is on but bias cancellation is not enabled.

V^+ : Positive Supply to Amplifier. Valid range is from 2.8V to 11.75V when V^- is 0V.

V^- : Negative Supply to Amplifier. Typically 0V. This can be made a negative voltage as long as $2.8V \leq (V^+ - V^-) \leq 11.75V$

APPLICATIONS INFORMATION

Circuit Description

The LTC6228/LTC6229 have an input signal range that extends from the negative power supply to 1.2V below the positive power supply. Figure 1 depicts a simplified schematic of the amplifier. The input stage consists of PNP transistors Q1 and Q2. At the input stage, devices Q18 and Q19 act to cancel the bias current of the input pair when bias cancellation is enabled. Bootstrap transistor Q13 and R5 match the collector and emitter voltages of Q11 and Q12, thus enhancing gain by improving output impedance. By making the collector current of Q13 twice that of Q11 and Q12, the base currents of Q11 and Q12 do not contribute towards mismatch between the collector currents of Q9 and Q8. This improves DC accuracy. A pair of complementary common emitter stages, Q15 and Q14, enables the output to swing to either rail. The $\overline{\text{SHDN}}$ Interface block translates the $\overline{\text{SHDN}}$ signal into 2 signals, pwr_dn for powering down the device (by deactivating current sources I1 - I4) and putting the output in a high impedance state (by shorting the bases of Q15/Q14 to the

supplies via M2 and M1), and disable_bias , which disables the input bias cancellation circuit, by shorting the base of Q19 to V^- through M3.

Input Bias Current

The LTC6228 family has an input bias current of approximately $16\mu\text{A}$. For the LTC6228 and the LTC6229DD10, the input bias current can be reduced to under $2.5\mu\text{A}$ at room temperature when the $\overline{\text{SHDN}}$ pin voltage is taken to within 350mV of the positive power supply. This capability enables the input bias current cancellation circuitry, allowing the amplifiers to be used in DC applications involving source impedances.

When input bias current cancellation is enabled and the input common mode voltage is within approximately 500mV of V^- , the bias cancellation is no longer effective, because transistors Q18 and Q19 in Figure 1 enter saturation. The input bias current can then exceed $50\mu\text{A}$ or higher, which is more than the input bias current

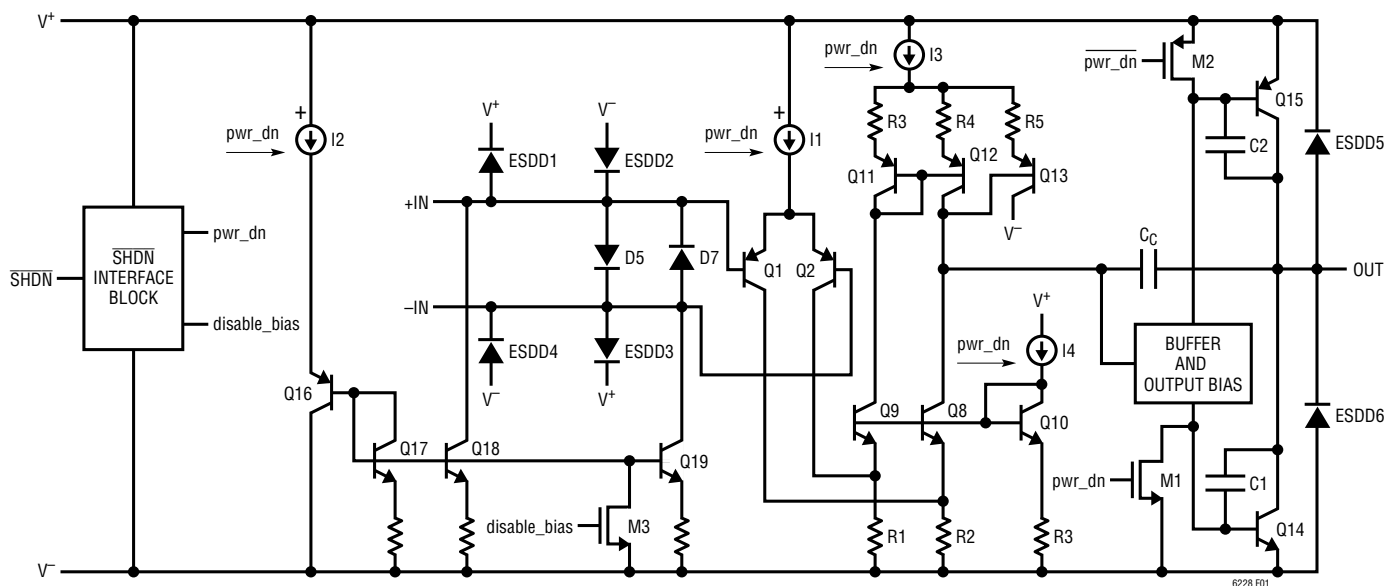

Figure 1. LTC6228 Simplified Schematic Diagram

APPLICATIONS INFORMATION

without input bias cancellation. Additionally when input bias current cancellation is enabled, the current noise increases. The decision to use input bias cancellation should be made with the end application's specifications and conditions in mind.

If the $\overline{\text{SHDN}}$ pin is left floating, input bias cancellation is not enabled, which may be suitable for many applications.

Output

The LTC6228 family has excellent output drive capability. The amplifiers can typically deliver more than 90mA of output current at a total supply of 10V, and can typically swing to within 320mV of the supply with load currents as high as 25mA. As the supply voltage to the amplifier decreases, the output current capability also decreases. Attention must be paid to keep the junction temperature of the IC below 150°C (refer to Power Dissipation section) when the output is in continuous short-circuit. The output of the amplifier has reverse-biased diodes connected to each supply. If the output is forced beyond either supply, extremely high currents will flow through those diodes, which may result in damage to the device.

Input Protection

The LTC6228 has a pair of back to back diodes (D5 and D7) to prevent the emitter base breakdown of the input transistors and limit the differential input to $\pm 700\text{mV}$. Unlike many other high performance amplifiers, the bases of the input pair transistors Q1 and Q2 are not connected to the pins through internal resistors to limit input current, since doing so would cause the noise to increase. For instance, a 100Ω resistor in series with each input generates $1.8\text{nV}/\sqrt{\text{Hz}}$ of noise, and the total amplifier noise voltage would rise from $0.88\text{nV}/\sqrt{\text{Hz}}$ to $2\text{nV}/\sqrt{\text{Hz}}$. If the input differential voltage exceeds $\pm 0.7\text{V}$, current conducted through the protection diodes D5 and D7 should be limited to under 10mA. This implies 25Ω of protection resistance per quarter volt (250mV) of overdrive beyond $\pm 0.7\text{V}$. In addition, the input and shutdown pins

have reverse biased diodes connected to the supplies. The current in these diodes must be limited to under 10mA. The amplifiers should not be used as comparators or in other open loop applications.

ESD

The LTC6228 family has reverse biased ESD protection diodes on all inputs as shown in Figure 1. There is an additional clamp between the positive and negative supplies that further protects the device during ESD strikes.

Hot plugging of the device into a powered socket should be avoided since this can trigger the clamp resulting in larger currents flowing between the supply pins.

Capacitive Loads

Because the LTC6228/LTC6229 is designed for high bandwidth applications, the output has not been designed to drive capacitive loads directly. Load capacitance at the output creates a non-dominant pole in the open loop frequency response, worsening the phase margin. When driving capacitive loads, a resistor of 10Ω to 100Ω should be connected between the amplifier output and the capacitive load to avoid ringing or oscillation. The feedback should be taken directly from the amplifier output. Higher voltage gain configurations tend to have better capacitive drive capability than lower gain configurations due to lower closed loop bandwidth. The graphs titled Series Output Resistor vs Capacitive Load demonstrate the transient response of the amplifier when driving capacitive loads with various series resistors.

Feedback Components

When feedback resistors are used to set up gain, care must be taken to ensure that the non-dominant pole formed by the feedback resistors and the parasitic capacitance at the inverting input does not degrade stability. For example if the amplifier is set up in a gain of +2 configuration with gain and feedback resistors of 1k, a parasitic capacitance of 7pF (device + PC board) at the amplifier's

APPLICATIONS INFORMATION

inverting input will cause the part to oscillate, due to the pole formed at 45MHz. Adding a capacitor of 7pF across the feedback resistor as shown in Figure 2 will eliminate any ringing or oscillation. In general, if the resistive feedback network results in a pole whose frequency lies within the closed loop bandwidth of the amplifier, a capacitor can be added in parallel with the feedback resistor to introduce a zero whose frequency is close to the frequency of the pole, improving stability.

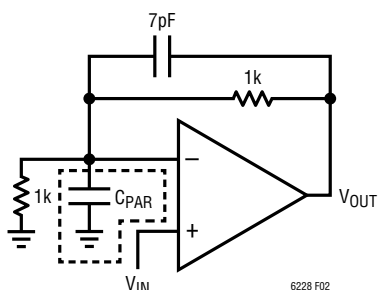

Figure 2. 7pF Feedback Cancels Parasitic Pole

For high speed designs, minimizing parasitic inductance is important. The use of capacitors where the electrodes are terminated on the long side instead of the short side (for example the use of 0306 instead of 0603 components) can help in this regard.

Shutdown

The LTC6228/LTC6229 have shutdown pins ($\overline{\text{SHDN}}$), which disable the amplifiers and reduce the quiescent current per channel to approximately 500 μ A. The $\overline{\text{SHDN}}$ pin needs to be driven at least 2.75V below V^+ to disable amplifier operation. For total supply voltages of 5V and or less, the amplifier can be disabled at a pin voltage of $V^+ - 2.65$ V. During shutdown, the output transistors Q15 and Q14 in Figure 1 are placed into a high impedance state. If $\overline{\text{SHDN}}$ is left floating, the pin is internally biased to 1.2V below the positive supply, and the amplifier remains on.

Power Dissipation

Care must be taken to ensure that the junction temperature of the die does not exceed 150°C.

The junction temperature, T_J , is calculated from the ambient temperature, T_A , power dissipation, P_D , and thermal resistance, θ_{JA} :

$$T_J = T_A + (P_D \cdot \theta_{JA}).$$

The power dissipation in the IC is a function of the supply voltage, output voltage and load resistance. For a given supply voltage with output load connected to mid supply, the worst-case power dissipation $P_{D(\text{MAX})}$ occurs when the supply current is maximum and the output voltage at half of either supply voltage for a given load resistance. $P_{D(\text{MAX})}$ is approximately (since I_S actually changes with output load current) given by:

$$P_{D(\text{MAX})} = (2 \cdot V_S \cdot I_{S(\text{MAX})}) + (V_S/2)^2/R_L$$

Example: For an LTC6228 in a 6-lead DC package operating on ± 5 V supplies and driving a 500 Ω load to ground, the worst-case power dissipation is approximately given by $P_{D(\text{MAX})}/\text{Amp} = (10 \cdot 19\text{mA}) + (5)^2/500 = 240\text{mW}$.

At the Absolute Maximum ambient operating temperature, the junction temperature under these conditions will be:

$$T_J = T_A + (P_D \cdot \theta_{JA}) = 125 + 0.24 \cdot 80 = 144.2^\circ\text{C}$$

which is slightly less than the absolute maximum junction temperature for the LTC6228/LTC6229.

Refer to the Pin Configuration section for thermal resistances of various packages

Board Layout and Bypass Capacitors

High speed and RF board layout techniques should be used due to the very high speeds of the signals involved. For the LTC6228 SOIC-8 package option, the feedback should be taken from the FB pin rather than from the output pin, to reduce signal trace length.

APPLICATIONS INFORMATION

Stray capacitances at the –IN and +IN pins should be made as low as possible to reduce stability degradation. For example, ground or supply planes on a PCB should not encompass the areas just beneath the input pins.

For single supply applications, it is recommended that high quality 0.1µF||1000pF ceramic bypass capacitors be placed directly between each V⁺ pin and its closest V[–] pin with short connections. The V[–] pins (including the Exposed Pad) should be tied directly to a low impedance ground plane with minimal routing. For dual (split) power supplies, it is recommended that additional high quality 0.1µF||1000pF ceramic capacitors be used to bypass V⁺ pins to ground and V[–] pins to ground, again with minimal routing.

Noise Considerations

The ultralow input referred voltage noise of 0.88nV/√Hz is equivalent to that of a 47Ω resistor at room temperature. As with all BJT input amplifiers, lowering input referred voltage noise is achieved by increasing the collector current of the input differential pair, which increases the input referred current noise.

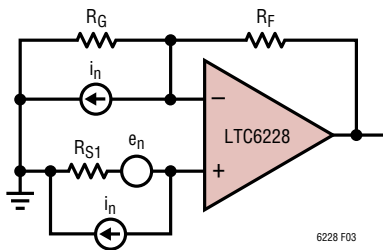

Figure 3.

Figure 3 shows the LTC6228 in a typical gain configuration.

As can be seen, the input referred noise spectral density of the gain stage (e_T) can be calculated by the following equations:

$$e_T^2 = \underbrace{e_n^2}_{\text{opamp voltage noise}} + \underbrace{i_n^2 R_{EQ}^2}_{\text{opamp current noise}} + \underbrace{4KTR}_{\text{resistor thermal noise}} R_{EQ}$$

Where

$$R_{EQ} = R_{S1} + R_G || R_F$$

Op amp input referred noise dominates the input referred noise of the gain stage when

$$R_{EQ} \ll e_n^2 / 4KT$$

Resistor noise dominates the input referred noise of the gain stage when

$$R_{EQ} \gg e_n^2 / 4KT \text{ and } R_{EQ} \ll 4KT / i_n^2$$

Op amp input referred current noise dominates the input referred noise when

$$R_{EQ} \gg 4KT / i_n^2$$

To summarize, initially e_n dominates for low resistance values. As the resistance increased, resistor noise starts to dominate, then on further increase current noise dominates.

With an input referred voltage noise spectral density of 0.88nV/√Hz and an input referred current noise of 3pA/√Hz (bias cancellation disabled), it is easy to see that the gain stage's input referred noise is dominated by op amp voltage noise when $R_{EQ} \ll 47\Omega$ and by resistor noise when

$$55\Omega \ll R_{EQ} \ll 1.8k\Omega.$$

Above an R_{EQ} of 1.8kΩ, input referred current noise dominates.

Distortion/Noise Trade-Off

As evident from the previous section, gain stage noise can be reduced by reducing R_{EQ} . However, reducing R_{EQ} , by reducing R_F and R_G , has its disadvantages. In addition to increasing power dissipation in the presence of large output signals, the use of smaller resistors for a given gain results in increased distortion, because the internal nonlinearities of the op amp worsen with increasing load current. In addition, smaller resistors decrease op amp gain and hence can affect bandwidth. The disadvantage, however of making the resistors too large is that parasitic capacitance can start to affect the gain at high frequencies. Hence when designing a system using the LTC6228, it is recommended that the resistor values be limited only by the system noise requirements, with the caveat that the effect of the impedances parasitic capacitances shouldn't affect the gain below the intended bandwidth. For example, for a feedback resistor of 5k, a parasitic capacitor of 400fF will impact gain at frequencies above 79MHz.

TYPICAL APPLICATIONS

18-Bit High Speed ADC Driver

The ultralow noise and distortion performance of the LTC6228 makes it an excellent candidate for driving high speed high resolution ADCs with fast, large amplitude signals. Figure 4 shows a pair of LTC6228s driven by a differential input, driving an LTC2387-18, a 15MSPS, 18-bit ADC. Figure 5 shows an FFT obtained with a -1dBFS , 1MHz input signal. The obtained SNR is 93.4dB, better than the LTC2387-18's guaranteed SNR of 93dB, and close to its typical value of 95.7dB. Spurious free dynamic range is an excellent 95dB, close to the LTC2387-18's guaranteed SFDR of 97dB.

High Speed Low Voltage Low Noise Instrumentation Amplifier

Figure 6 shows a three op amp instrumentation amplifier with a gain of 41V/V which can operate on a wide range

of supply voltage. An RC snubber is used at the common terminal of the 30Ω gain setting resistors to reduce the effects of any board induced layout coupling from the output of one amplifier to the negative input of the other. Figure 7 shows the measured frequency response of the instrumentation amplifier for a load of $1\text{k}\Omega$. Figure 8 shows the measured CMRR of the instrumentation amplifier, and Figure 9 shows the transient response for a $50\text{mV}_{\text{P-P}}$ input square wave applied to the positive input, with the negative input grounded. The total supply voltage was 3.3V. The extremely low offset voltage and low $1/f$ noise at the LTC6229 inputs allow for wide band instrumentation amplifier operation, down to DC. Note, the bias currents of the LTC6229 are higher than might appear in a traditional low speed instrumentation amplifier. High speed instrumentation such as in Figure 6 assume a correspondingly low enough impedance excitation.

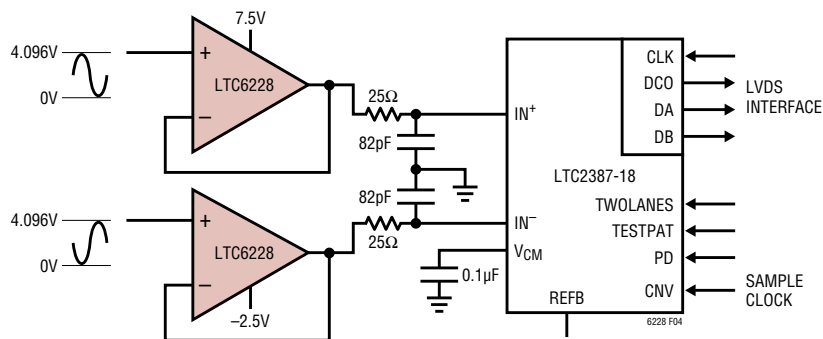

Figure 4. High Speed Driver for 18-Bit ADC

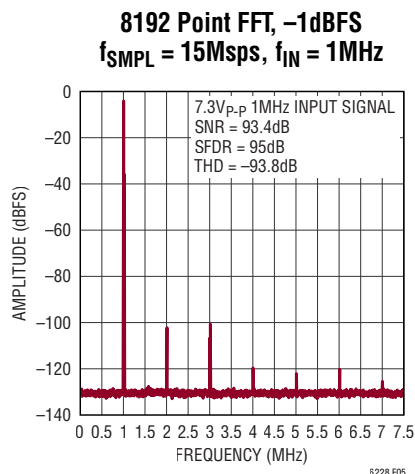

Figure 5. Measured Performance of LTC6228 Based Driver Driving the LTC2387-18

TYPICAL APPLICATIONS

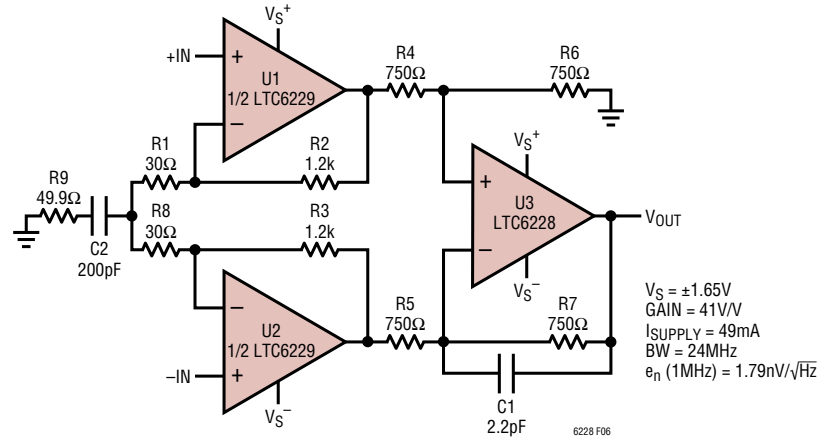

Figure 6. High Speed Low Voltage Low Noise Instrumentation Amplifier

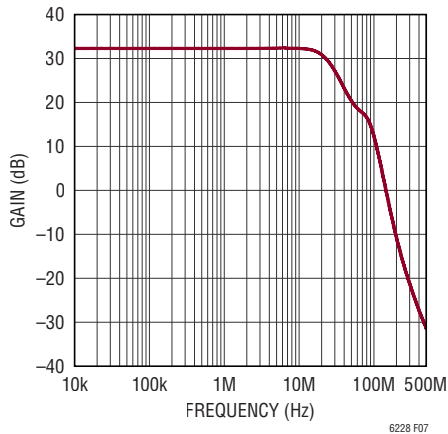

Figure 7. Instrumentation Amplifier Frequency Response

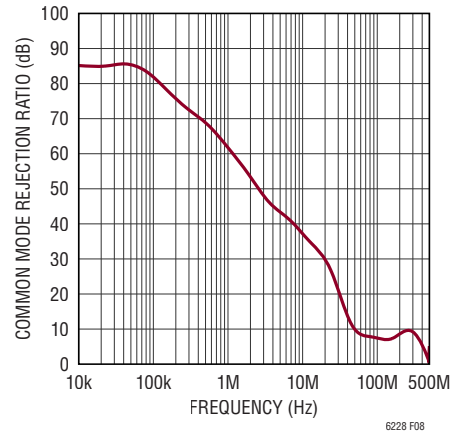

Figure 8. Instrumentation Amplifier CMRR

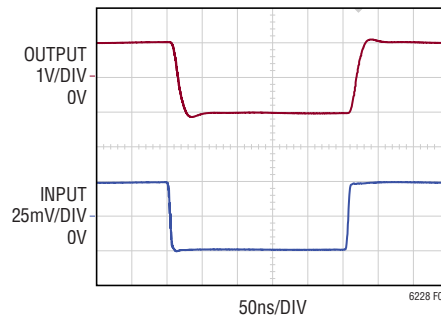

Figure 9. Transient Response

TYPICAL APPLICATIONS

Wideband Differential to Single-Ended Converter

The combination of high slew rate and bandwidth enables the LTC6228 to be used as a translator for large signals at high frequencies.

Figure 10 shows the implementation of a wide band, differential to single-ended converter with a gain of -6dB

using just one LTC6228. Figure 11 shows the frequency response of the circuit for a differential input of $2\text{V}_{\text{P-P}}$. The bandwidth obtained was 50MHz . The common mode gain is shown in Figure 12, and is limited by the matching between the resistors in the circuit. Figure 13 shows the response of the driver to a $1\text{V}_{\text{P-P}}$ differential square wave signal.

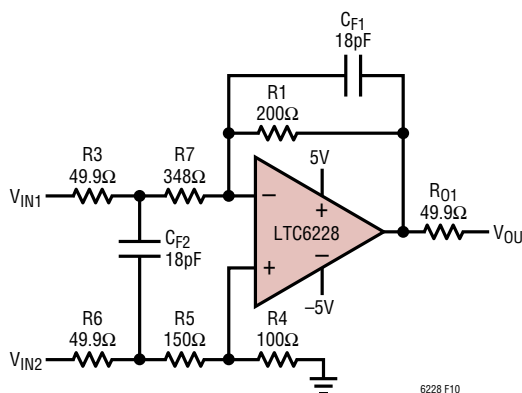

Figure 10. Wideband Differential to Single-Ended Converter

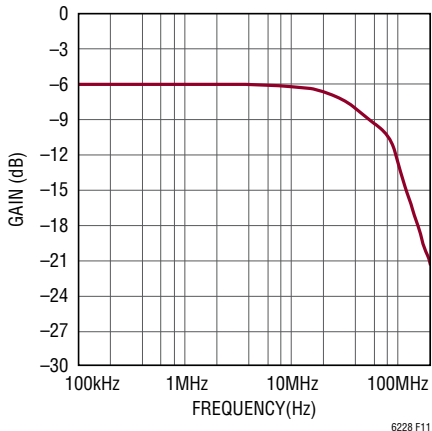

Figure 11. Frequency Response of Differential to Single-Ended Converter

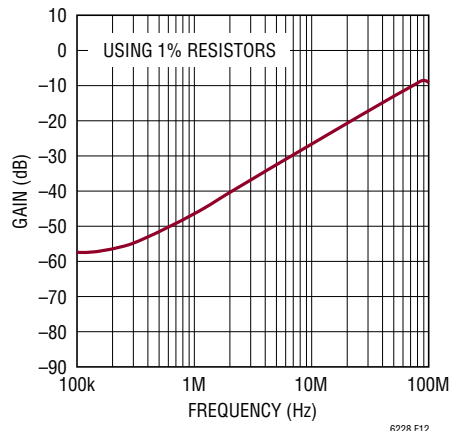

Figure 12. Common Mode Gain vs Frequency

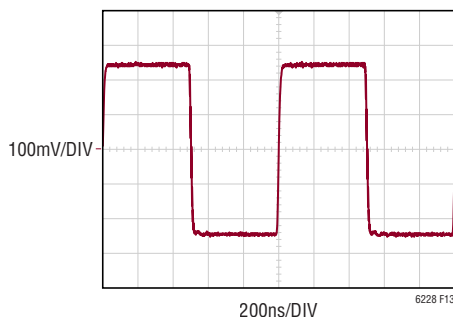
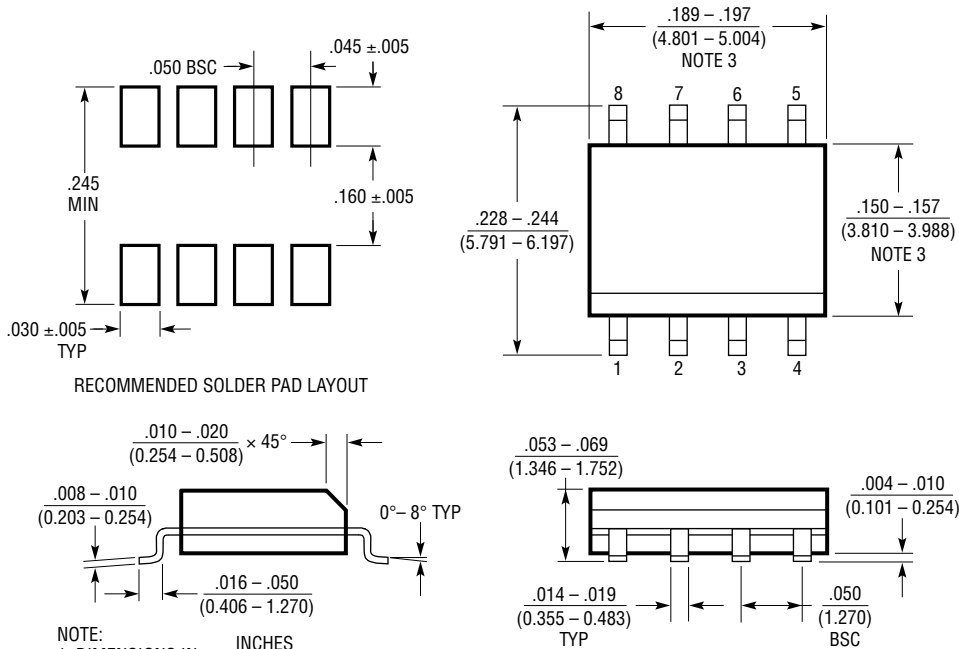

Figure 13. Pulse Response of the Differential to Single-Ended Converter

PACKAGE DESCRIPTION

S8 Package
8-Lead Plastic Small Outline (Narrow .150 Inch)
 (Reference LTC DWG # 05-08-1610 Rev G)



- NOTE:
1. DIMENSIONS IN INCHES (MILLIMETERS)
 2. DRAWING NOT TO SCALE
 3. THESE DIMENSIONS DO NOT INCLUDE MOLD FLASH OR PROTRUSIONS. MOLD FLASH OR PROTRUSIONS SHALL NOT EXCEED $.006"$ (0.15mm)
 4. PIN 1 CAN BE BEVEL EDGE OR A DIMPLE

S08 REV G 0212

PACKAGE DESCRIPTION

DC6 Package
6-Lead Plastic DFN (2mm × 2mm)
 (Reference LTC DWG # 05-08-1703 Rev C)

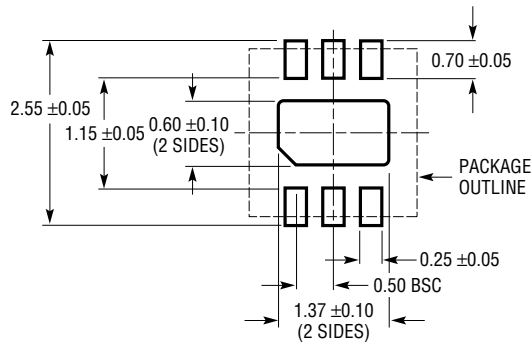

RECOMMENDED SOLDER PAD PITCH AND DIMENSIONS

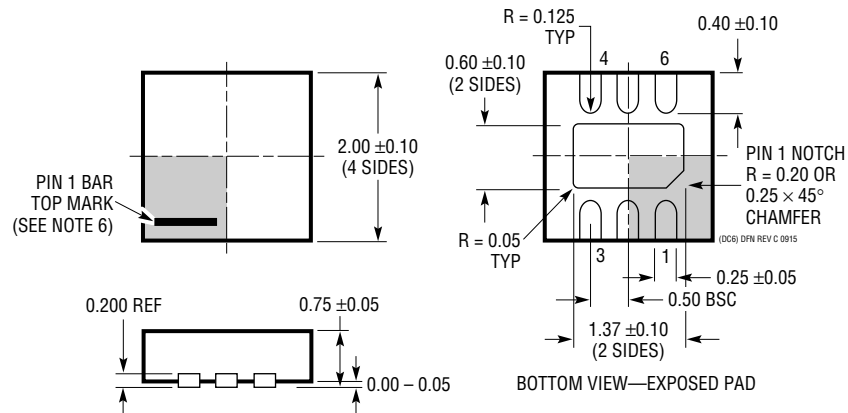

NOTE:

1. DRAWING TO BE MADE A JEDEC PACKAGE OUTLINE M0-229 VARIATION OF (WCCD-2)
2. DRAWING NOT TO SCALE
3. ALL DIMENSIONS ARE IN MILLIMETERS
4. DIMENSIONS OF EXPOSED PAD ON BOTTOM OF PACKAGE DO NOT INCLUDE MOLD FLASH. MOLD FLASH, IF PRESENT, SHALL NOT EXCEED 0.15mm ON ANY SIDE
5. EXPOSED PAD SHALL BE SOLDER PLATED
6. SHADED AREA IS ONLY A REFERENCE FOR PIN 1 LOCATION ON THE TOP AND BOTTOM OF PACKAGE

PACKAGE DESCRIPTION

S6 Package
6-Lead Plastic TSOT-23
 (Reference LTC DWG # 05-08-1636)

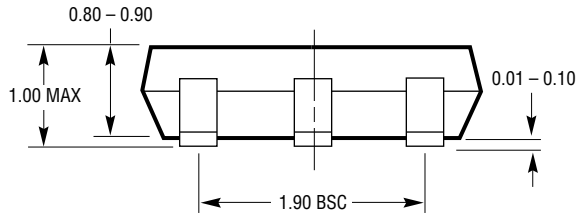
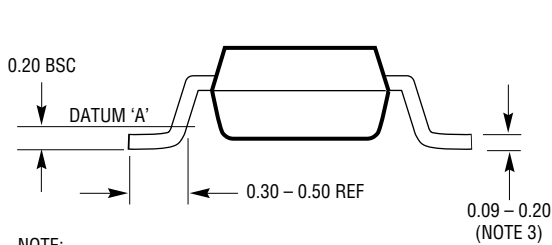
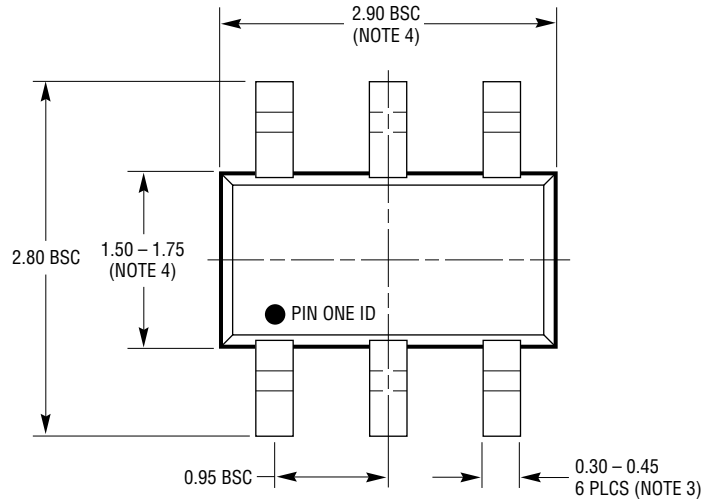
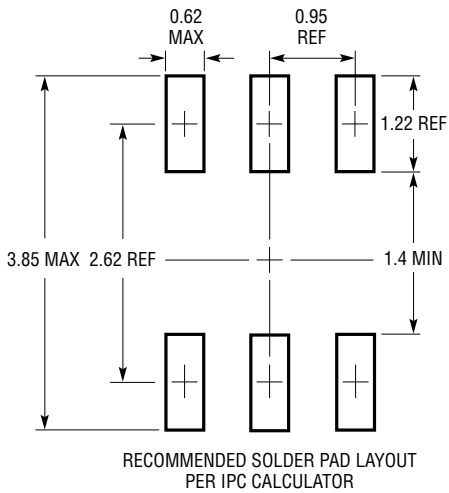

- NOTE:
1. DIMENSIONS ARE IN MILLIMETERS
 2. DRAWING NOT TO SCALE
 3. DIMENSIONS ARE INCLUSIVE OF PLATING
 4. DIMENSIONS ARE EXCLUSIVE OF MOLD FLASH AND METAL BURR
 5. MOLD FLASH SHALL NOT EXCEED 0.254mm
 6. JEDEC PACKAGE REFERENCE IS MO-193

S6 TSOT-23 0302

PACKAGE DESCRIPTION

DD Package 10-Lead Plastic DFN (3mm × 3mm) (Reference LTC DWG # 05-08-1699 Rev C)

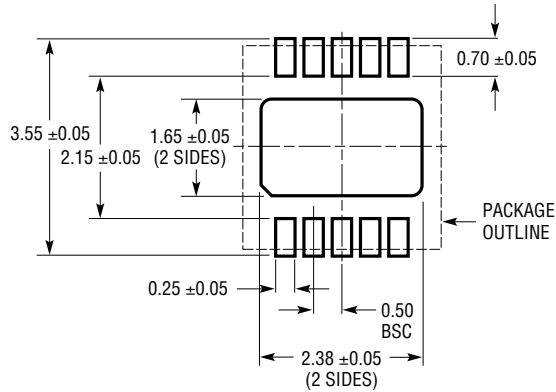

RECOMMENDED SOLDER PAD PITCH AND DIMENSIONS

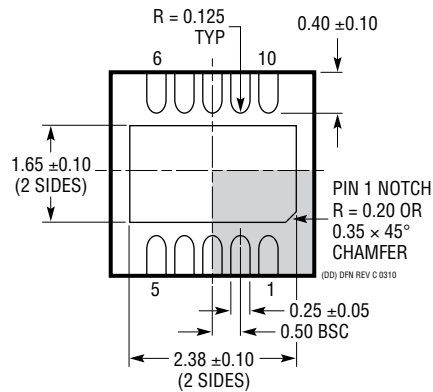
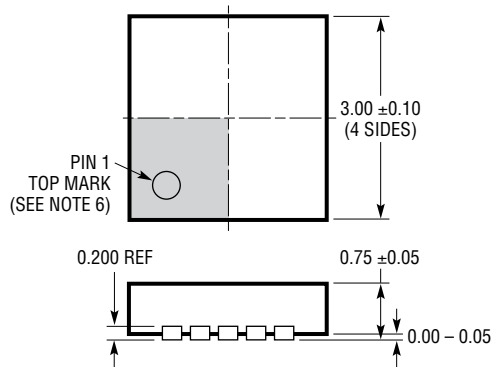

BOTTOM VIEW—EXPOSED PAD

NOTE:

1. DRAWING TO BE MADE A JEDEC PACKAGE OUTLINE MO-229 VARIATION OF (WEED-2). CHECK THE LTC WEBSITE DATA SHEET FOR CURRENT STATUS OF VARIATION ASSIGNMENT
2. DRAWING NOT TO SCALE
3. ALL DIMENSIONS ARE IN MILLIMETERS
4. DIMENSIONS OF EXPOSED PAD ON BOTTOM OF PACKAGE DO NOT INCLUDE MOLD FLASH. MOLD FLASH, IF PRESENT, SHALL NOT EXCEED 0.15mm ON ANY SIDE
5. EXPOSED PAD SHALL BE SOLDER PLATED
6. SHADED AREA IS ONLY A REFERENCE FOR PIN 1 LOCATION ON THE TOP AND BOTTOM OF PACKAGE

PACKAGE DESCRIPTION

MS8E Package 8-Lead Plastic MSOP, Exposed Die Pad (Reference LTC DWG # 05-08-1662 Rev K)

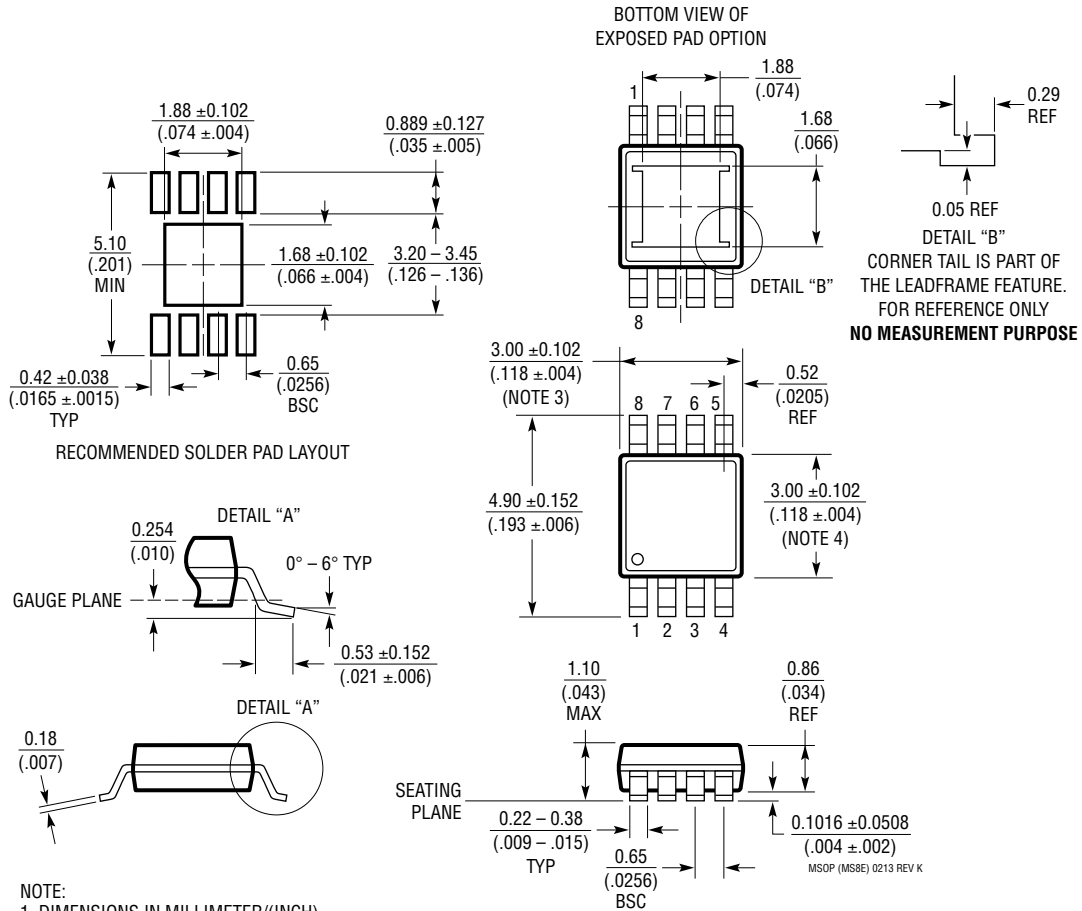

NOTE:

1. DIMENSIONS IN MILLIMETER/(INCH)
2. DRAWING NOT TO SCALE
3. DIMENSION DOES NOT INCLUDE MOLD FLASH, PROTRUSIONS OR GATE BURRS.
MOLD FLASH, PROTRUSIONS OR GATE BURRS SHALL NOT EXCEED 0.152mm (.006") PER SIDE
4. DIMENSION DOES NOT INCLUDE INTERLEAD FLASH OR PROTRUSIONS.
INTERLEAD FLASH OR PROTRUSIONS SHALL NOT EXCEED 0.152mm (.006") PER SIDE
5. LEAD COPLANARITY (BOTTOM OF LEADS AFTER FORMING) SHALL BE 0.102mm (.004") MAX
6. EXPOSED PAD DIMENSION DOES INCLUDE MOLD FLASH. MOLD FLASH ON E-PAD SHALL NOT EXCEED 0.254mm (.010") PER SIDE.

REVISION HISTORY

| REV | DATE | DESCRIPTION | PAGE NUMBER |
|-----|-------|------------------------------------------------|------------------|
| A | 09/19 | Added LTC6229 to data sheet. | All |
| B | 03/20 | Corrected wording and values on various pages. | 1, 9, 17, 20, 30 |

TYPICAL APPLICATION

High Speed High Dynamic Range Photodiode Amplifier

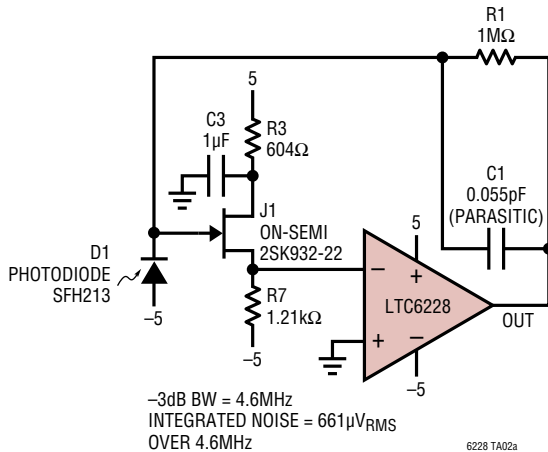

Photodiode Amplifier Noise Spectrum

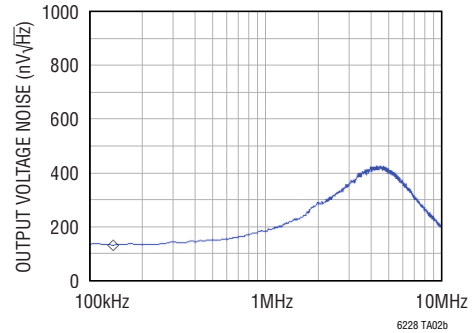

Photodiode Amplifier Transient Response

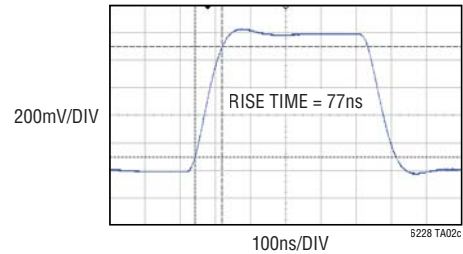

RELATED PARTS

| PART NUMBER | DESCRIPTION | COMMENTS |
|-----------------------------------------|-------------------------------------------------------------------|----------------------------------------------------------------------------------|
| Operational Amplifiers | | |
| LTC6252/LTC6253/LTC6254 | Single/Dual/Quad High Speed Rail-to-Rail Input and Output Op Amps | 720MHz, 3.5mA, 2.75nV/√Hz, 280V/μs, 0.35mV, Unity Gain Stable |
| LTC6268-10/LTC6269-10 | Single/Dual High Speed FET Input Op Amp | 4GHz, 4nV/√Hz, ±3f _A Input Bias Current |
| ADA4897-1 | 1nV/√Hz, Low Power Rail-to-Rail Output | 230MHz, 120V/μs |
| LT1806/LT1807 | Single/Dual Low Noise Rail-to-Rail Input and Output Op Amps | 325MHz, 13mA, 3.5nV/√Hz, 140V/μs, 550μV, 85mA Output Drive |
| LTC6246/LTC6247/LTC6248 | Single/Dual/Quad High Speed Rail-to-Rail Input and Output Op Amps | 180MHz, 1mA, 4.2nV/√Hz, 90V/μs, 0.5mV |
| LT6238/LT6237/LT6232 | Single/Dual/Quad Low Noise Rail-to-Rail Output Op Amps | 215MHz, 3.5mA, 1.1nV/√Hz, 70V/μs, 350μV |
| LT6200/LT6201 | Single/Dual Ultralow Noise Rail-to-Rail Input/Output Op Amps | 165MHz, 20mA, 0.95nV/√Hz, 44V/μs, 1mV |
| AD8099 | Ultralow Distortion Low Noise High Speed Op Amp | 0.95nV/√Hz, 3.8GHz GBW |
| LT1468 | 16-Bit Accurate Precision High Speed Op Amp | 90MHz, 3.9mA, 5nV/√Hz, 22V/μs, 175μV, -96.5dB THD at 10V _{P-P} , 100kHz |
| ADA4899-1 | Unity Gain Stable Ultra Low Distortion 1nV/√Hz | 600MHz, 310V/μs, 4.5V to 10V Operation |
| LT1028/LT1128 | Ultralow Noise, Precision High Speed Op Amps | 75MHz, 9.5mA, 0.85nV/√Hz, 11V/μs, 40μV |
| ADCs | | |
| LTC2387-18 | 18-Bit, 15Msps SAR-ADC | 95.7dB SNR |
| LTC2393-16 | 1Msps 16-Bit SAR-ADC | 94dB DNR |
| LTC2378-20 | 20-bit, 1 Msps Low Power SAR-ADC | 104 dB SNR/-105dB THD at 100kHz |
| AD7625 | 16-Bit 6Msps PuISAR® ADC | 93dB SNR |
| AD4020 | 20-Bit, 1.8Msps Precision SAR-ADC | 99dB SNR/-100db THD at 100kHz |

Rev. B

Looking for pricing, stock, or lifecycle information?

Click below to explore more details on WIN SOURCE:

 [View LTC6228IDC#TRPBF on WIN SOURCE](#)

 [Analog Devices Inc. Information](#)

Optimize Your Supply Chain with WIN SOURCE Solutions

-  Global Sourcing Solution
-  Obsolete Management
-  Cost Control Management
-  Shortage Management
-  Alternative Solution
-  Excess Inventory Management