



THE DATASHEET OF TSC2100EVM



TSC2100EVM

Touch Screen Controller Evaluation Module

User's Guide

IMPORTANT NOTICE

Texas Instruments Incorporated and its subsidiaries (TI) reserve the right to make corrections, modifications, enhancements, improvements, and other changes to its products and services at any time and to discontinue any product or service without notice. Customers should obtain the latest relevant information before placing orders and should verify that such information is current and complete. All products are sold subject to TI's terms and conditions of sale supplied at the time of order acknowledgment.

TI warrants performance of its hardware products to the specifications applicable at the time of sale in accordance with TI's standard warranty. Testing and other quality control techniques are used to the extent TI deems necessary to support this warranty. Except where mandated by government requirements, testing of all parameters of each product is not necessarily performed.

TI assumes no liability for applications assistance or customer product design. Customers are responsible for their products and applications using TI components. To minimize the risks associated with customer products and applications, customers should provide adequate design and operating safeguards.

TI does not warrant or represent that any license, either express or implied, is granted under any TI patent right, copyright, mask work right, or other TI intellectual property right relating to any combination, machine, or process in which TI products or services are used. Information published by TI regarding third-party products or services does not constitute a license from TI to use such products or services or a warranty or endorsement thereof. Use of such information may require a license from a third party under the patents or other intellectual property of the third party, or a license from TI under the patents or other intellectual property of TI.

Reproduction of information in TI data books or data sheets is permissible only if reproduction is without alteration and is accompanied by all associated warranties, conditions, limitations, and notices. Reproduction of this information with alteration is an unfair and deceptive business practice. TI is not responsible or liable for such altered documentation.

Resale of TI products or services with statements different from or beyond the parameters stated by TI for that product or service voids all express and any implied warranties for the associated TI product or service and is an unfair and deceptive business practice. TI is not responsible or liable for any such statements.

Mailing Address:

Texas Instruments
Post Office Box 655303
Dallas, Texas 75265

EVM IMPORTANT NOTICE

Texas Instruments (TI) provides the enclosed product(s) under the following conditions:

This evaluation kit being sold by TI is intended for use for **ENGINEERING DEVELOPMENT OR EVALUATION PURPOSES ONLY** and is not considered by TI to be fit for commercial use. As such, the goods being provided may not be complete in terms of required design-, marketing-, and/or manufacturing-related protective considerations, including product safety measures typically found in the end product incorporating the goods. As a prototype, this product does not fall within the scope of the European Union directive on electromagnetic compatibility and therefore may not meet the technical requirements of the directive.

Should this evaluation kit not meet the specifications indicated in the EVM User's Guide, the kit may be returned within 30 days from the date of delivery for a full refund. **THE FOREGOING WARRANTY IS THE EXCLUSIVE WARRANTY MADE BY SELLER TO BUYER AND IS IN LIEU OF ALL OTHER WARRANTIES, EXPRESSED, IMPLIED, OR STATUTORY, INCLUDING ANY WARRANTY OF MERCHANTABILITY OR FITNESS FOR ANY PARTICULAR PURPOSE.**

The user assumes all responsibility and liability for proper and safe handling of the goods. Further, the user indemnifies TI from all claims arising from the handling or use of the goods. Please be aware that the products received may not be regulatory compliant or agency certified (FCC, UL, CE, etc.). Due to the open construction of the product, it is the user's responsibility to take any and all appropriate precautions with regard to electrostatic discharge.

EXCEPT TO THE EXTENT OF THE INDEMNITY SET FORTH ABOVE, NEITHER PARTY SHALL BE LIABLE TO THE OTHER FOR ANY INDIRECT, SPECIAL, INCIDENTAL, OR CONSEQUENTIAL DAMAGES.

TI currently deals with a variety of customers for products, and therefore our arrangement with the user **is not exclusive**.

TI assumes **no liability for applications assistance, customer product design, software performance, or infringement of patents or services described herein**.

Please read the EVM User's Guide and, specifically, the EVM Warnings and Restrictions notice in the EVM User's Guide prior to handling the product. This notice contains important safety information about temperatures and voltages. For further safety concerns, please contact the TI application engineer.

Persons handling the product must have electronics training and observe good laboratory practice standards.

No license is granted under any patent right or other intellectual property right of TI covering or relating to any machine, process, or combination in which such TI products or services might be or are used.

Mailing Address:

Texas Instruments
Post Office Box 655303
Dallas, Texas 75265

EVM WARNINGS AND RESTRICTIONS

It is important to operate this EVM within the input voltage range of 6 VDC to 12 VDC and output voltage of 3 VDC described in the EVM User's Guide.

Exceeding the specified input range may cause unexpected operation and/or irreversible damage to the EVM. If there are questions concerning the input range, please contact a TI field representative prior to connecting the input power.

Applying loads outside of the specified output range may result in unintended operation and/or possible permanent damage to the EVM. Please consult the EVM User's Guide prior to connecting any load to the EVM output. If there is uncertainty as to the load specification, please contact a TI field representative.

During normal operation, some circuit components may have case temperatures greater than 40°C. The EVM is designed to operate properly with certain components above 40°C as long as the input and output ranges are maintained. These components include but are not limited to linear regulators, switching transistors, pass transistors, and current sense resistors. These types of devices can be identified using the EVM schematic located in the EVM User's Guide. When placing measurement probes near these devices during operation, please be aware that these devices may be very warm to the touch.

Mailing Address:

Texas Instruments
Post Office Box 655303
Dallas, Texas 75265

Read This First

About This Manual

This users guide describes the function and operation of the TSC2100 touch screen controller evaluation module. This manual will help you quickly set up the evaluation board and its accompanying software, so that you can rapidly test and evaluate the TSC2100. A complete circuit description, as well as schematic diagram and bill of materials are included.

How to Use This Manual

This manual begins with an introductory chapter that describes the EVM and what it can do. If you are anxious to setup the EVM and start testing, we suggest you read at least the first two chapters. These two chapters introduce you to the board and how to set it up. Later chapters go into more detail on the board's design and how to access its many features.

Information About Cautions and Warnings

This document may contain cautions and warnings.

This is an example of a caution statement.

A caution statement describes a situation that could potentially damage your software or equipment.

This is an example of a warning statement.

A warning statement describes a situation that could potentially cause harm to you.

The information in a caution or a warning is provided for your protection. Please read each caution and warning carefully.

Related Documentation From Texas Instruments

To obtain a copy of any of the following TI documents, call the Texas Instruments literature response center at (800) 477-8924 or the product information center (PIC) at (972) 644-5580. When ordering, please identify this booklet by its title and literature number. Updated documents can also be obtained through the TI website at www.ti.com.

Data Sheets:

TSC2100
TAS1020B
TPS767D318
SN74LVC125A

Literature Number:

SLAS378
SLES025A
SLVS209D
SCAS290M

If You Need Assistance

If you have questions about this or other Texas Instruments data converter evaluation modules, feel free to e-mail the data converter application team at dataconvapps@list.ti.com. Include the product name in the subject heading.

FCC Warning

This equipment is intended for use in a laboratory test environment only. It generates, uses, and can radiate radio frequency energy and has not been tested for compliance with the limits of computing devices pursuant to subpart J of part 15 of FCC rules, which are designed to provide reasonable protection against radio frequency interference. Operation of this equipment in other environments may cause interference with radio communications, in which case the user at his own expense will be required to take whatever measures may be required to correct this interference.

Trademarks

Windows is a registered trademark of Microsoft Corporation.
TouchTek 4 and MicroTouch are trademarks of 3M.

Contents

1	Introduction	1-1
1.1	Device Characteristics	1-2
1.2	EVM Block Diagram	1-2
1.3	Analog Inputs/Outputs	1-3
1.4	Power Requirements	1-3
1.5	Computer Requirements	1-3
2	Getting Started	2-1
2.1	Unpacking the EVM	2-2
2.2	Default Configuration	2-2
2.3	Quick Start	2-2
3	Operation	3-1
3.1	Jumpers	3-2
3.1.1	Differential Microphone Input	3-2
3.1.2	MIC BIAS Selection	3-2
3.1.3	EEPROM A1 Select	3-2
3.1.4	Power Supply Selection	3-2
3.2	Switches	3-2
3.2.1	SPI Selection	3-3
3.2.2	I ² S Selection	3-3
3.2.3	MCLK Selection	3-3
3.3	I/O Connector and Signals	3-3
3.3.1	Audio Connectors	3-3
3.3.2	USB Interface Connector	3-4
3.3.3	External Power Connectors	3-4
3.3.4	External Audio Data (I ² S) Connector	3-5
3.3.5	External SPI Connector	3-5
3.3.6	Touch Screen Connectors	3-5
3.3.7	Analog Input Connector	3-6
3.4	Circuit Description	3-6
3.4.1	USB Microprocessor	3-6
3.4.2	Power Supply	3-7
3.4.3	Touch Screen and Analog Inputs	3-7
3.4.4	Voltage Reference	3-7
3.4.5	Audio Interface Circuitry	3-8
3.5	Program Description	3-8
3.5.1	Human Interface Screen	3-8
3.5.2	Data Acquisition Screen	3-9

3.5.3	Configuration Screen	3-14
3.5.4	Audio Screen	3-17
3.5.5	Bass Boost Filter Screen	3-20
4	Physical Description	4-1
4.1	Component Locations	4-2
4.2	Bill of Materials	4-3
4.3	Schematics	4-6

Figures

1-1	TSC2100 Evaluation Kit Block Diagram	1-2
2-1	Default Software Screen	2-3
3-1	Human Interface Screen	3-9
3-2	Data Acquisition Screen	3-10
3-3	Touch Screen Control Registers Screen	3-11
3-4	Audio Control Registers Screen	3-12
3-5	Audio Base Boost Filter Coefficients Screen	3-13
3-6	Configuration Screen	3-14
3-7	Configuration Screen With External Reference Selection	3-16
3-8	Audio Screen	3-17
3-9	Audio Screen With AGC On	3-19
3-10	Bass Boost Filter Screen	3-21

Tables

2-1	Default Configuration Settings	2-2
3-1	Jumper/Function Reference	3-2
3-2	Switch Function Reference	3-3
3-3	Audio Connectors	3-4
3-4	USB Interface Connector	3-4
3-5	External Power Connectors	3-4
3-6	Audio Data Connector	3-5
3-7	External SPI Connector	3-5
3-8	Touch Screen Input	3-5
3-9	Analog Input Connector	3-6

Introduction

The TSC2100 is an advanced touch screen controller, which communicates to a host processor through an SPI serial interface. In addition, a mono-input/stereo-output audio codec is included in the TSC2100, and audio data is communicated to the device over an I²S bus. The TSC2100EVM accesses both of these buses through the use of a USB microcontroller, which provides a way to generate data for both buses from a PC running Windows® 98, Windows 2000, or Windows XP.

Topic	Page
1.1 Device Characteristics	1-2
1.2 EVM Block Diagram	1-2
1.3 Analog Inputs/Outputs	1-3
1.4 Power Requirements	1-3
1.5 Computer Requirements	1-3

1.1 Device Characteristics

The TSC2100 is a complete PDA analog interface circuit. It contains a complete 12-bit A/D resistive touch screen converter, including the drivers and the control to measure touch pressure. The TSC2100 interfaces to the host controller through a standard SPI serial interface. The TSC2100 offers two battery measurement inputs capable of reading battery voltages up to 6 V, while operating with only a 2.7-V supply. It also has an on-chip temperature sensor capable of reading 1°C resolution.

In addition to these features, the TSC2100 has audio playback and record capabilities. Access to the DAC and ADC sections of the TSC2100 is through an I²S interface.

1.2 EVM Block Diagram

A block diagram of the TSC2100 evaluation kit is shown in Figure 1–1.

Figure 1–1. TSC2100 Evaluation Kit Block Diagram

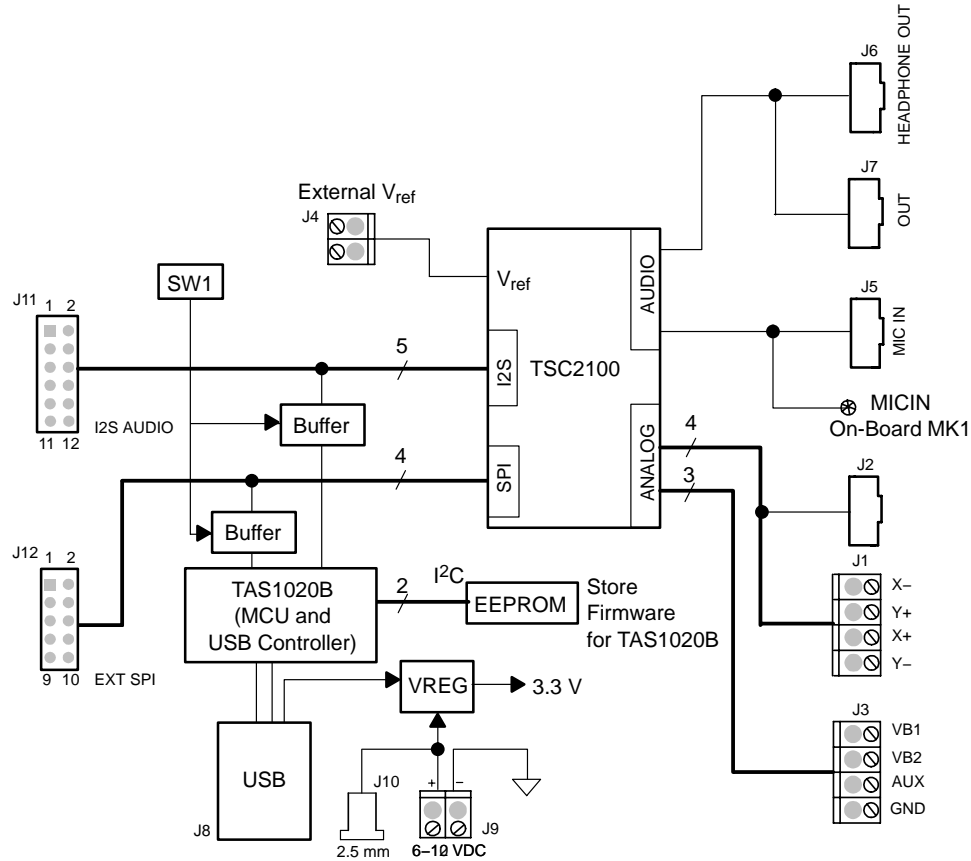

The digital control interface is through either the USB bus or an external SPI bus. The onboard microprocessor can be disabled, allowing the external SPI bus to control the TSC2100.

Power supplies are derived from the USB bus, or may be provided to the kit through external connectors from an external user-supplied laboratory power supply.

1.3 Analog Inputs/Outputs

Touch screen inputs are provided to the controller through J2. This connector is standard on 3M Touch Systems™ (formerly MicroTouch™) TouchTek 4™ touch screens. Alternate touch screen input connections are provided on the J1 terminal block. The other analog inputs are brought onto the board through the J3 terminal block. The AUX input must be between 0 V and 3.3 V, while the battery inputs, VBAT1 and VBAT2 can range from 0 V to 6 V.

On the audio side, the signal comes from either the on-board microphone MK1 or an external microphone, connected to J5. The audio output is accessed through connectors J6 and/or J7.

1.4 Power Requirements

The TSC2100EVM can be powered from either the USB port or an external 6-VDC to 10-VDC power supply.

1.5 Computer Requirements

The TSC2100EVM software is designed to run on a PC running Windows™ platforms that support USB (Windows™ 98SE, 2000, XP, etc).

Minimum requirements include:

- IBM-compatible Pentium PC or higher
- Windows™ 98SE/2000/XP
- 64-MByte RAM minimum
- 20-MByte Available hard disk space
- CD-ROM drive
- USB Port



THIS PAGE INTENTIONALLY LEFT BLANK

Getting Started

This chapter guides you through unpacking your EVM and setting it up so you can begin working with it immediately.

Topic	Page
2.1 Unpacking the EVM	2-2
2.2 Default Configuration	2-2
2.3 Quick Start	2-2

2.1 Unpacking the EVM

When unpacking the TSC2100EVM, check to make sure that you received all of the material that should be in the box. The EVM kit should include the following:

- TSC2100EVM board, PWB 6444324
- CD-ROM, 6444327

If any of these components is missing, contact Texas Instruments for a replacement.

2.2 Default Configuration

The TSC2100EVM features a few simple means of configuring its operation. The default settings for these items are shown in Table 2–1. When you unpack your TSC2100EVM, make sure that your board is initially configured as listed in the table.

Table 2–1. Default Configuration Settings

Board Identifier	Description	Default Setting	
JMP1	Differential MIC input	Not installed	
JMP2	MIC BIAS select	2 to 3	
JMP3	A1 select for EEPROM	Installed	
JMP4	PWR select	1 to 2	
SW1	On board TAS1020B enable	On board I2S	SW1_1 ON
		On board MCLK	SW1_2 ON
		On board SPI	SW1_3 ON
		Spare	SW1_4 OFF

2.3 Quick Start

Once the TSC2100EVM has been unpacked and you have verified that the board is configured as shown in Table 2–1, install the software.

Place the CD-ROM into your PC's CD-ROM drive. Locate the Setup program on the disk and run it. The Setup program installs the TSC2100EVM software on your PC. Note that if you are running Windows™ 2000 or XP, you need administrator privileges to install the software. Follow the instructions that the installer gives you.

When the installation is complete, connect a USB cable from your PC to the TSC2100EVM. You may see a message that a Human Interface Device has been connected. Once this connection has been made, launch the TSC2100EVM software on your PC.

The software should automatically find the TSC2100EVM. If the board is found, the screen shown in Figure 2–1 appears.

Figure 2-1. Default Software Screen

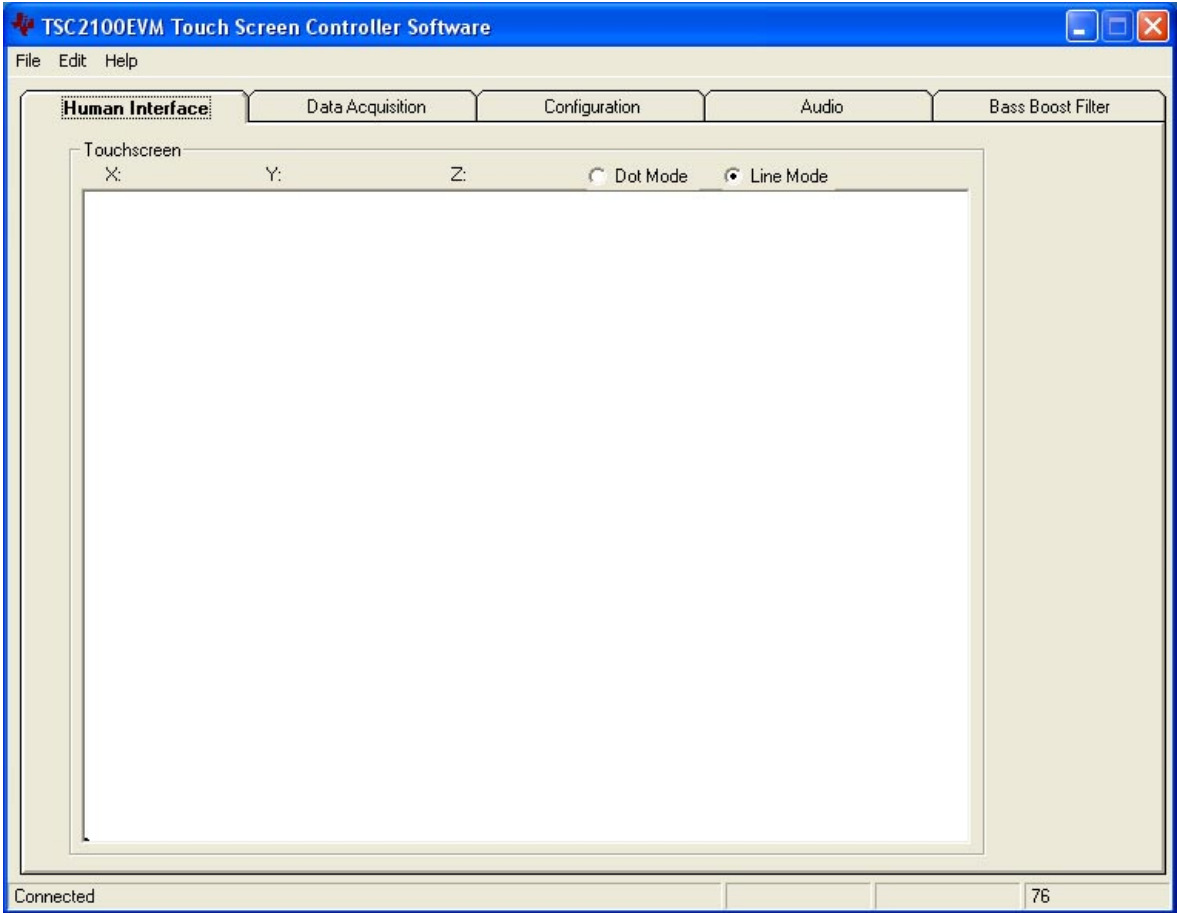

In order to use the touch screen features, a 4-wire resistive touch screen must be connected to J2 or J1 of the TSC2100EVM.



THIS PAGE INTENTIONALLY LEFT BLANK

Operation

This chapter describes each function of the TSC2100 evaluation kit and how to use the accompanying software to control and use the TSC2100.

Topic	Page
3.1 Jumpers	3-2
3.2 Switches	3-2
3.3 I/O Connectors and Signals	3-3
3.4 Circuit Description	3-6
3.5 Program Description	3-8

3.1 Jumpers

Table 3–1 shows the function of each jumper on the EVM.

Table 3–1. Jumper/Function Reference

Reference Designator	Setting	Function	Factory Default	Subsection
JMP1	1 to 2	Differential (MICIN and AUX) microphone input	Not installed	3.1.1
JMP2	1 to 2	MIC BIAS from fixed resistor	2 to 3	3.1.2
	2 to 3	MIC BIAS from TSC2100		
JMP3	1 to 2	A1 select for EEPROM	Installed	3.1.3
JMP4	1 to 2	PWR select: USB powered	1 to 2	3.1.4
	2 to 3	PWR select: External power supply		

3.1.1 Differential Microphone Input

The microphone signal can be input to the TSC2100 through the MICIN or AUX, if the signal is single ended. In single-ended mode, JMP1 should be removed. The microphone signal, if differential, can be connected to the TSC2100 through J5 and to the TSC2100 MICIN and AUX pins. In differential mode, JMP1 should be installed.

3.1.2 MIC BIAS Selection

JMP2 selects the microphone bias to come from the TSC2100 itself or from an external resistor, R11, which is not installed on the TSC2100EVM board. If an external bias is needed, the appropriate size resistor can be soldered into the R11 location on the board and JMP2 set to connect between positions 1 and 2. If MIC BIAS is not required, do not install the jumper top for JMP2 in any position.

3.1.3 EEPROM A1 Select

The TSC2100EVM loads its firmware from an onboard EEPROM. In order to use the firmware in this EEPROM, its address A2, A1, A0 should be 000b. JMP3 is used to pull the A1 line low so that the EEPROM is selected. When A1 is not low, the EEPROM is not able to interface to the on-board TAS1020B processor.

This jumper can be removed when firmware updates are to be made.

3.1.4 Power Supply Selection

The TSC2100EVM can be powered from the USB port directly, or an external power supply can be provided through J9 or J10. JMP4 selects between the USB and external power sources.

3.2 Switches

The SW1 switch on the board to gives users the option to select SPI and I²S as well as MCLK signal resources.

Table 3–2 shows the function of the switch.

Table 3–2. Switch Function Reference

Reference Designator		Setting	Function	Factory Default	Subsection
SW1	SW1-1	ON	On-board I ² S selected	ON	3.2.2
		OFF	External I ² S selected		
	SW1-2	ON	On-board MCLK selected	ON	3.2.3
		OFF	External MCLK selected		
	SW1-3	ON	On-board SPI selected	ON	3.2.1
		OFF	External SPI selected		

3.2.1 SPI Selection

The SPI bus on the TSC2100 provides the main interface between a host-processor and the TSC2100 device. The on-board TAS1020B plays the role of the host processor, if SW1-3 is set ON. If an external processor or SPI device is used, set the SW1-3 to the OFF position so as to disable the on-board SPI interface to the TAS1020B and open the TSC2100 SPI port to the external SPI bus.

3.2.2 I²S Selection

The I²S bus on the TSC2100 can interface with the onboard host processor, the TAS1020B USB controller, or with other offboard external I²S processor or devices. When SW1-1 is set ON, the manufacture default, the TSC2100 I²S is connected to the TAS1020B's I²S. Otherwise, if SW1-1 is shifted to OFF, the buffer between the on board I²S port is disabled so that an external I²S can communicate with the TSC2100 I²S port.

3.2.3 MCLK Selection

The TSC2100 requires a proper MCLK for basic audio ADC/DAC functions. The TAS1020B onboard processor generates an 11.2896-MHz frequency to provide the MCLK. If an external MCLK is preferred, SW1-2 should be turned off.

3.3 I/O Connector and Signals

The various connectors on the TSC2100EVM are described in this section.

3.3.1 Audio Connectors

The TSC2100 audio inputs and outputs are routed through these stereo (TIP/RING/SLEEVE) 3.5-mm jacks. Note the polarity of the channel assignments for these connectors.

Table 3–3. Audio Connectors

Reference Designator	Name	Description
J5	Mic In	Microphone input <input type="checkbox"/> tip = mic bias voltage (and MIC input–, if different) <input type="checkbox"/> ring = mic input+ <input type="checkbox"/> sleeve = ground
J6	Headphone Out	Stereo headphone audio outputs <input type="checkbox"/> tip = left channel <input type="checkbox"/> ring = right channel <input type="checkbox"/> sleeve = virtual ground
J7	Line Out	Stereo headphone output with ac coupling <input type="checkbox"/> tip = left channel <input type="checkbox"/> ring = right channel <input type="checkbox"/> sleeve = ground

3.3.2 USB Interface Connector

Connection to a USB cable from a PC is made through J8, a standard USB type B receptacle.

Table 3–4. USB Interface Connector

Reference Designator	Description	Pin Number	Signal Name	Function
J8	USB slave connection to PC	1	VCC	+ 5-V supply from USB
		2	D–	– Differential USB signal
		3	D+	+ Differential USB signal
		4	GND	Ground

3.3.3 External Power Connectors

While it is most convenient to power the TSC2100EVM from the USB bus, external power supplies can be used. The two connectors detailed in Table 3–5 are provided for the external power.

Table 3–5. External Power Connectors

Reference Designator	Description	Pin Number	Signal Name
J9	External power terminal block	1	6 VDC to 10 VDC input
		2	Ground
J10	External power jack	–	6 VDC to 10 VDC input, positive center terminal

3.3.4 External Audio Data (I²S) Connector

The I²S bus, which carries audio data to and from the TSC2100, is brought out to header J11 and can be connected to external I²S devices if the I²S interface to the on-board TAS1020B is disabled.

Table 3–6. Audio Data Connector

Reference Designator	Description	Pin Number	Signal Name
J11	Audio data (I ² S) connector	1	MCLK
		3	BCLK
		5	LRCLK
		7	I2SDIN
		9	I2SDOUT
		11	PWD/AWDS
		2,4,6,8,10,12	Ground

3.3.5 External SPI Connector

The TSC2100 SPI port is brought out to the J12 header. It can be driven by an external source if the onboard microprocessor is disabled.

Table 3–7. External SPI Connector

Reference Designator	Description	Pin Number	Signal Name	Function
J12	External SPI Bus	1	NC	Not connected
		3	SS	Slave select for SPI bus.
		5	SCLK	Serial clock for SPI bus.
		7	MOSI	Master out, slave in data line for SPI bus. Data travels to the TSC2100 over this line.
		9	MISO	Master in, slave out data line for SPI bus. Data travels from the TSC2100 over this line.
		2, 4, 6, 8, 10	GND	Ground

3.3.6 Touch Screen Connectors

A 4-wire touch screen connects to the evm board through connector J2. This connector is standard on 3M Touch Systems (formerly MicroTouch) TouchTek 4 touch screens. A standard terminal block connection is available on J1 for those users who have touch screen connectors that do not match the J2 configuration.

Table 3–8. Touch Screen Input

Reference Designator	Description	Pin Number	Signal Name	Function
J2, J1	Touch screen input	1	X–	Touch screen X– electrode
		2	Y+	Touch screen Y+ electrode
		3	X+	Touch screen X+ electrode
		4	Y–	Touch screen Y– electrode

3.3.7 Analog Input Connector

The auxiliary and battery inputs to the touch screen controller are brought onto the EVM board through terminal block J3. The pinout is shown in Table 3–9.

Table 3–9. Analog Input Connector

Reference Designator	Description	Pin Number	Signal Name	Function
J3	Battery and auxiliary inputs to the touch screen control	1	VBAT1	Battery input 1, 0 V to 6 V
		2	VBAT2	Battery input 2, 0 V to 6 V
		3	AUX	Auxiliary input, 0 V to VREF
		4	GND	Ground

3.4 Circuit Description

The TSC2100 evaluation kit circuitry consists of a USB microprocessor, power supply circuitry, touch screen and analog input interfaces, and audio interface circuitry (both analog and digital). These circuits are described in the following sections.

3.4.1 USB Microprocessor

The TSC2100EVM has a USB interface for connecting to a PC. This connection is made through a TAS1020B streaming audio processor, U5.

The SPI interface to the TSC2100 can be controlled from two sources: the external SPI header, J12, or through the onboard microprocessor (U5) via USB. The U5 outputs are enabled only when the supplied firmware is loaded and the TAS SPI switch SW1-3 is turned on. The firmware resides in the serial EEPROM chip (U2). U5 only loads firmware from U2 when U2's A1 address line is pulled low. To disable firmware loading, A1 must be high, by having JM3 removed.

When the firmware is loaded and active, D2 (a yellow LED) is lit.

If no firmware is loaded, U3's outputs are in 3-state, allowing the external SPI bus to drive the TSC2100 and turn off SW1-3 to ensure the isolation of the TAS1020B from the SPI bus. When the firmware is loaded, the PC software enables the microprocessor to control the SPI bus.

CAUTION

Do not drive the external SPI bus when the firmware is loaded and the onboard microprocessor is active. Disable the microprocessor by removing JMP3, turn off SW1-3, and cycle power to the TSC2100EVM in order to use the external SPI bus.

Each signal from the SPI inputs is connected directly to the TSC2100. As such, signals on these pins must not exceed the power supply voltage of the TSC2100, which is 3.3 V on this EVM.

Likewise, the I²S signals for the digital audio can be driven either externally by J11 or by the USB audio controller (U5).

Do not drive the external I²S bus when the firmware is loaded and the onboard microprocessor is active. Disable the microprocessor by removing JMP3, turn off SW1-1 and SW1-2, and cycle power to the TSC2100EVM in order to use the external I²S bus.

3.4.2 Power Supply

Power to the TSC2100EVM can be derived directly from the USB interface or externally supplied through the J9 terminal block or the J10 barrel jack connector. Supply voltages of 6 VDC to 10 VDC must be supplied from an external supply. Since it is regulated on the TSC2100EVM, this input voltage does not need to be regulated, as long as it falls within this range. D1 prevents damage to the board in the event a power supply is connected in reverse polarity.

U6 regulates the input supply voltage to provide 1.8 V for the TSC2100's digital core and 3.3 V for the remaining hardware. The regulated supply voltages have LEDs attached that alert the user that the supply is working. D4 (red) is the indicator for the 1.8-V power supply and D3 (green) is the indicator for the 3.3-V power supply.

3.4.3 Touch Screen and Analog Inputs

Terminal block J3 provides input connection points for the battery and auxiliary inputs. Battery inputs can range from 0 V to 6 V, and the auxiliary input can range from 0 V to V_{reg} . The touch screen can be connected to J2 or to the J1 terminal block.

Each of these seven inputs to the TSC2100 internal touch screen ADC circuitry has a provision for an RC filter to be placed in line with the signal. As shipped, all of the resistors are 0 Ω and the capacitor is 0.01 μ F for C4 and not installed for C1 to C3 and C5 to C7. If noisy conditions prevent obtaining good readings from the TSC2100, 0.01- μ F to 0.1- μ F capacitors can be installed in positions C1 through C4. If more filtering is required, the 0- Ω resistors should be unsoldered from the board and replaced with small resistors. Note that increasing the capacitance on the touch screen inputs requires increased panel voltage stabilization time and increased precharge and sense times, thus lowering the available number of readings per second.

3.4.4 Voltage Reference

The TSC2100 has an internal voltage reference, selectable at 1.25 V or 2.5 V. If an external reference is preferred, the external voltage can be input from J4.

3.4.5 Audio Interface Circuitry

A mono electret microphone can be connected to J5. This jack provides both audio and bias connections. Bias for the microphone can be supplied either from the TSC2100's mic bias circuitry or from an external resistor (R11). R11 is not installed on the TSC2100EVM, but can be installed by the user. Internal or external bias is selected by JMP2.

There is also a small on-board microphone on the EVM, parallel to J5. Without an external electrical microphone, voice can be input to the TSC2100 through this microphone.

The TSC2100 has a built-in headphone amplifier. J6 is the jack for connection to the amplifier and for driving a 16- Ω load at over 25 mW.

Another audio output jack (J7) is parallel to J6 and provides a secondary connection to the TSC2100 built-in headphone amplifier (with ac coupling).

3.5 Program Description

After installing the software for the TSC2100EVM as described in Section 2.3, you may begin using it to evaluate and develop with the TSC2100.

3.5.1 Human Interface Screen

The program's interface is a simple, five-tab interface. Clicking on a tab takes you to the functions associated with that tab. The program begins on the Human Interface screen (the default) as shown in Figure 3–1.

Figure 3–1. Human Interface Screen

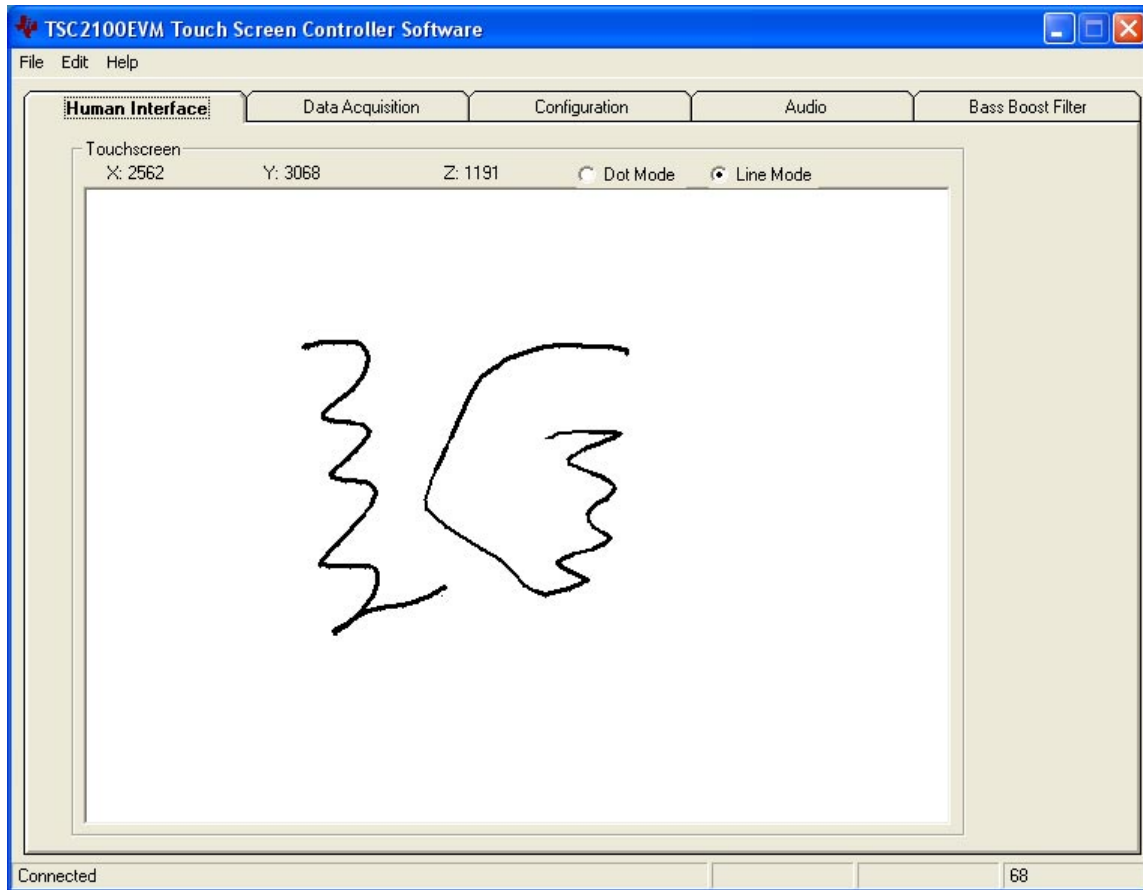

This screen reflects the touch screen from the TSC2100EVM. The status bar at the bottom of the screen is divided into four sections and shows the status of communication between the PC and the EVM. Starting from the left, the first section shows the status of the connection; if an error in communication occurs, an error message appears here, otherwise it looks as shown in Figure 3–1. The final section, on the right side of the status bar, shows the number of readings per second being taken from the touch screen.

The touch screen box on this screen is updated when a touch is detected on the touch screen. As the touch screen is drawn upon, the motion on the touch screen is translated into pixels on the screen. The software takes X, Y, and Z readings, which are shown at the top of this box. As the touch pressure is increased, the pixel size increases; a lighter touch results in smaller pixel sizes.

The display can be cleared by pressing the Enter or Backspace key on the PC keyboard.

3.5.2 Data Acquisition Screen

The data acquisition functions of the TSC2100 can be accessed on this screen as shown in Figure 3–2.

Figure 3–2. Data Acquisition Screen

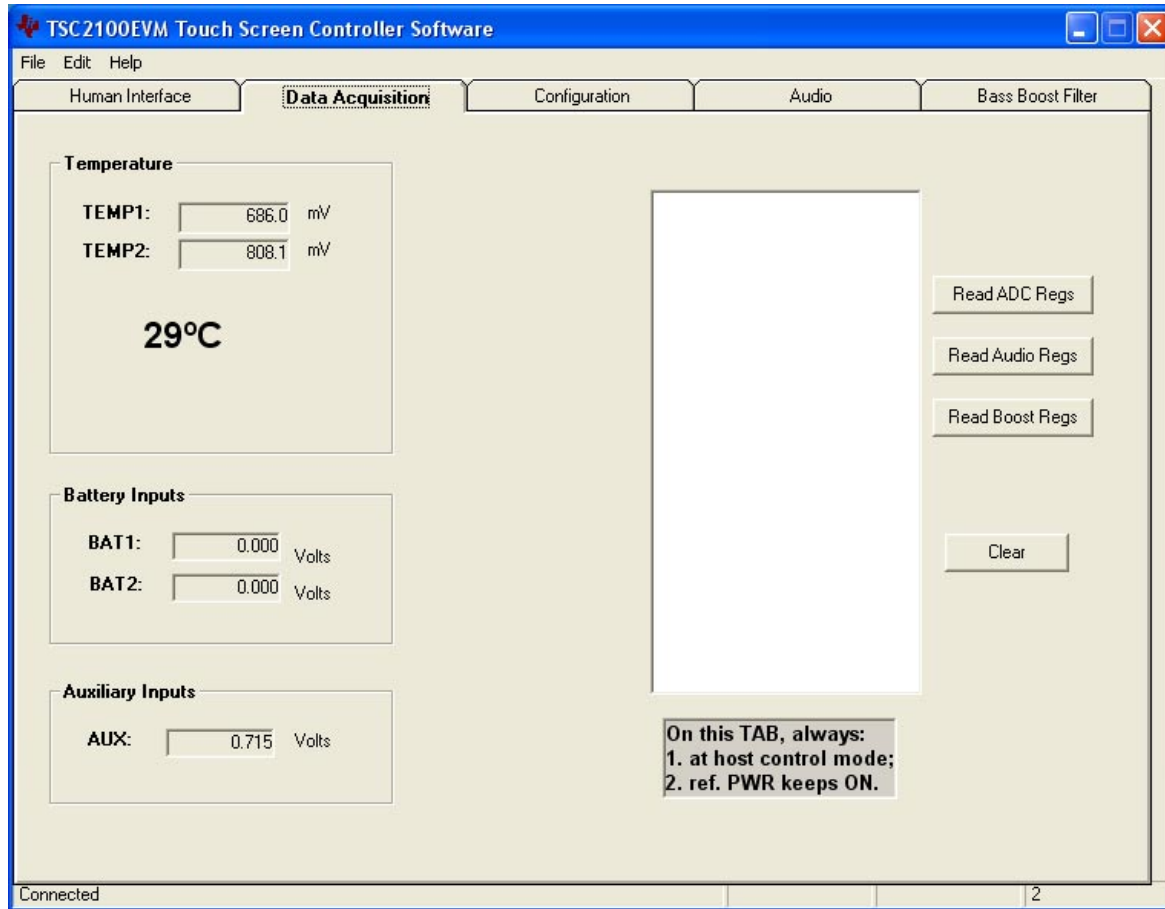

When on this screen, the TSC2100 is commanded to perform the battery and auxiliary input voltage readings, and then it is commanded to perform a TEMP1 and TEMP2 measurement. These measurements are all repeated twice every second, and the results are displayed on this screen.

On the right hand side of this screen there is a window that shows the TSC2100 internal control register values. The three buttons next to the window selects which group of control registers is required to be read and shown. The clear button clears the window contents.

This window is useful for debugging purposes.

Figure 3–3, Figure 3–4, and Figure 3–5 show the TSC2100 touch screen control registers, the TSC2100 audio control registers, and the TSC2100 audio base boost filter coefficients, respectively.

Figure 3–3. Touch Screen Control Registers Screen

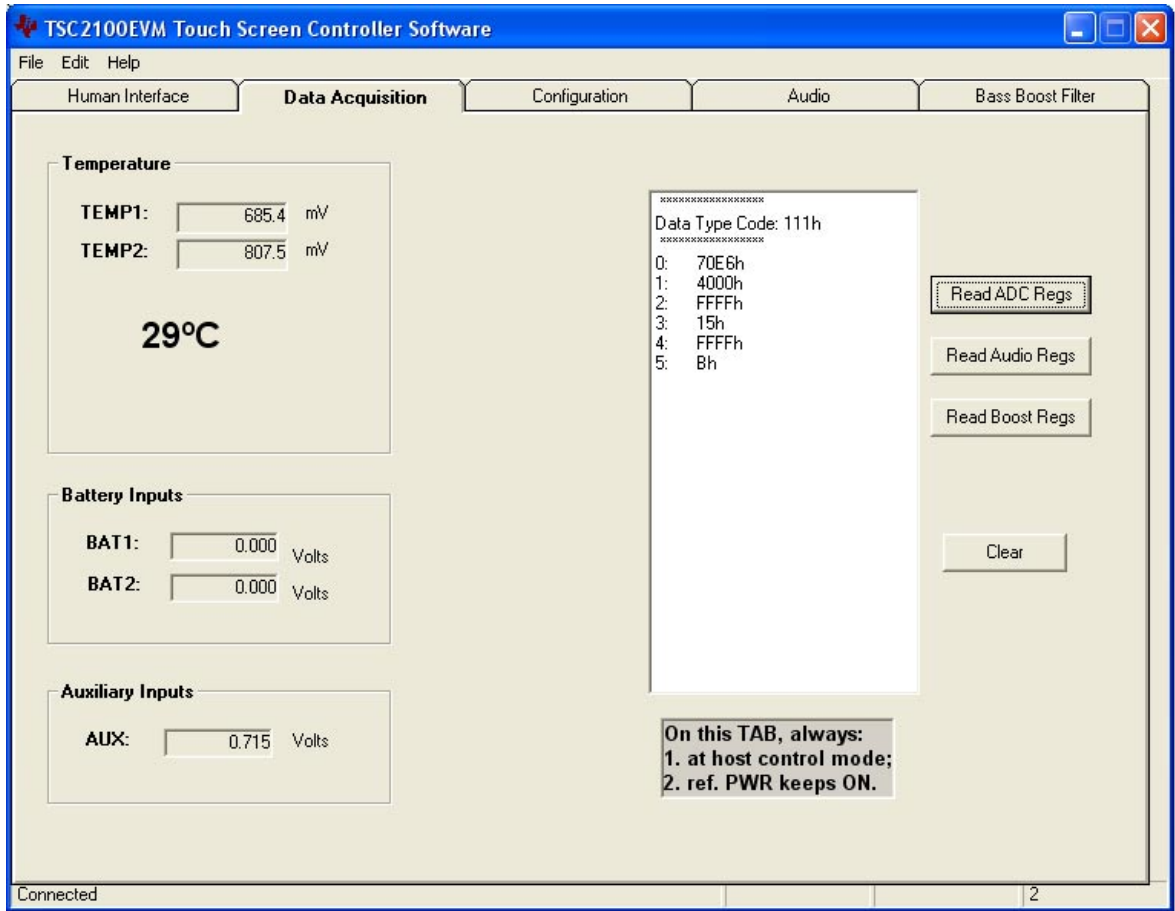

Figure 3–4. Audio Control Registers Screen

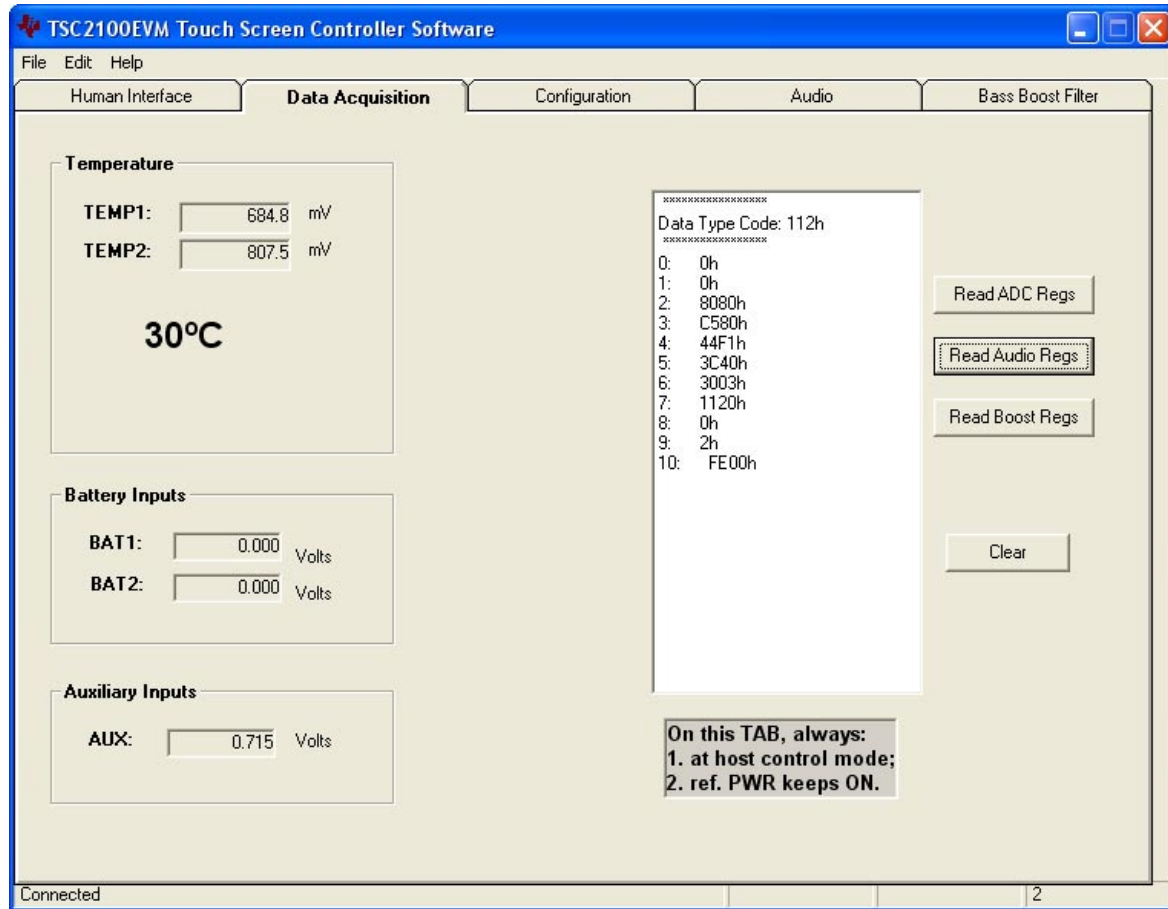
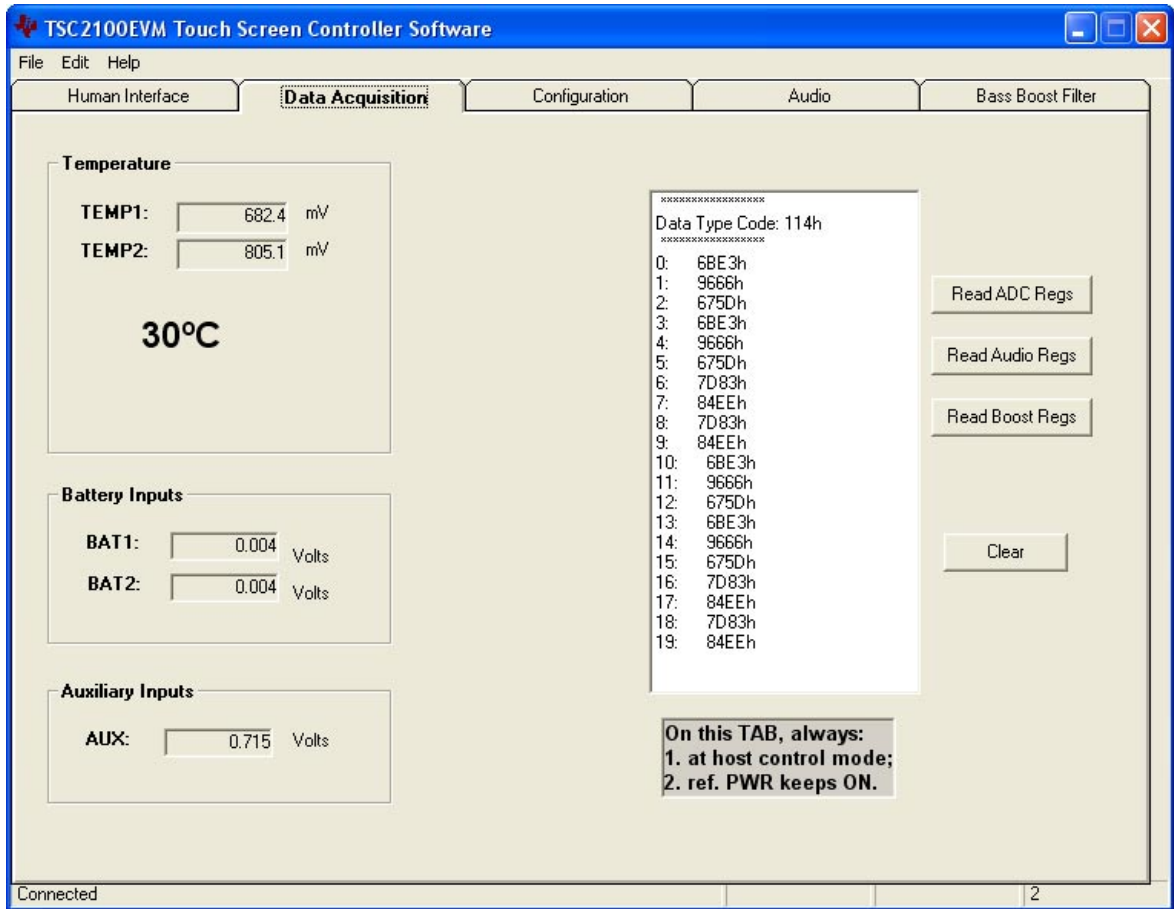

Figure 3-5. Audio Base-Boost Filter Coefficients Screen



3.5.3 Configuration Screen

This screen provides access to all of the configurable settings for the TSC2100's A/D converter and reference, as shown in Figure 3–6.

Located on the right hand side of the screen are the programmable phase lock loop (PLL) settings, which are not the A/D settings but the audio settings.

Figure 3–6. Configuration Screen

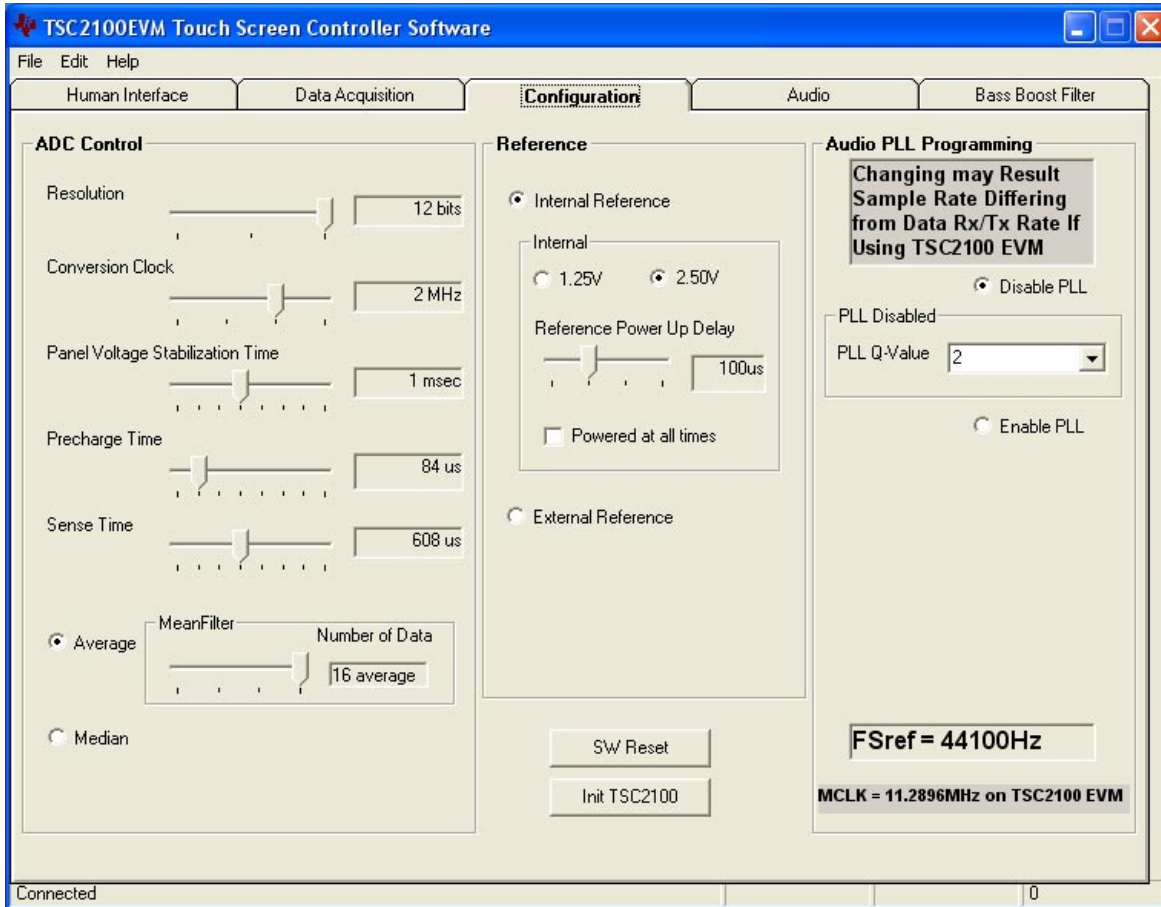

3.5.3.1 ADC Control Section

This section controls all of the parameters of the A/D converter. Each slider controls one parameter, whose value is shown next to the slider. Each slider is described below.

- Resolution
Selects between 8-, 10-, and 12-bit resolution.
- Conversion Clock
The internal clock which runs the A/D converter can run at 8, 4, 2, or 1 MHz. When running at 8 MHz, only 8-bit resolution is possible; when running at 4 MHz, 8- or 10-bit resolution is possible, but 12-bit is not. These restrictions are reflected in the operation of this program, since only 1- or 2-MHz clock rates allow 12-bit resolution to be chosen.

- Panel Voltage Stabilization Time

This is the time that the TSC2100 allows for the touch screen to settle after turning the drivers on.

- Precharge Time

- Sense Time

These two parameters are the time allowed to precharge the touch panel capacitance and then sense to see if the screen is touched. For more details on these parameters, refer to the TSC2100 data sheet.

- Average/Median

There are two ways to reduce noise effect to the ADC result. One is averaging where 4, 8, or 16 readings are averaged, and another option is to find the median value among 5, 9, or 15 readings.

Note that these settings apply to all operations of the A/D converter, not just the touch screen operations. Thus, resolution and averaging can be changed to increase accuracy in the data acquisition functions.

3.5.3.2 Reference Section

The touch screen function is always performed using a ratiometric mode; for all other A/D functions, a reference voltage is needed for the A/D converter. Figure 3–6 shows this section with the TSC2100's internal reference chosen. This reference voltage can be set to either 1.25 V or 2.5 V.

The internal reference powers down between conversions to save power. Using the *Powered at all times* checkbox, this can be overridden and the reference does not power down. If the reference is allowed to power down, the TSC2100 then must allow a delay time for the reference to power up when a conversion is to take place. This delay time can be set using the slider in this section.

If an external reference is to be used, it can be selected as shown in Figure 3–7. The value of the external reference should be entered in the text box shown.

Figure 3–7. Configuration Screen With External Reference Selection

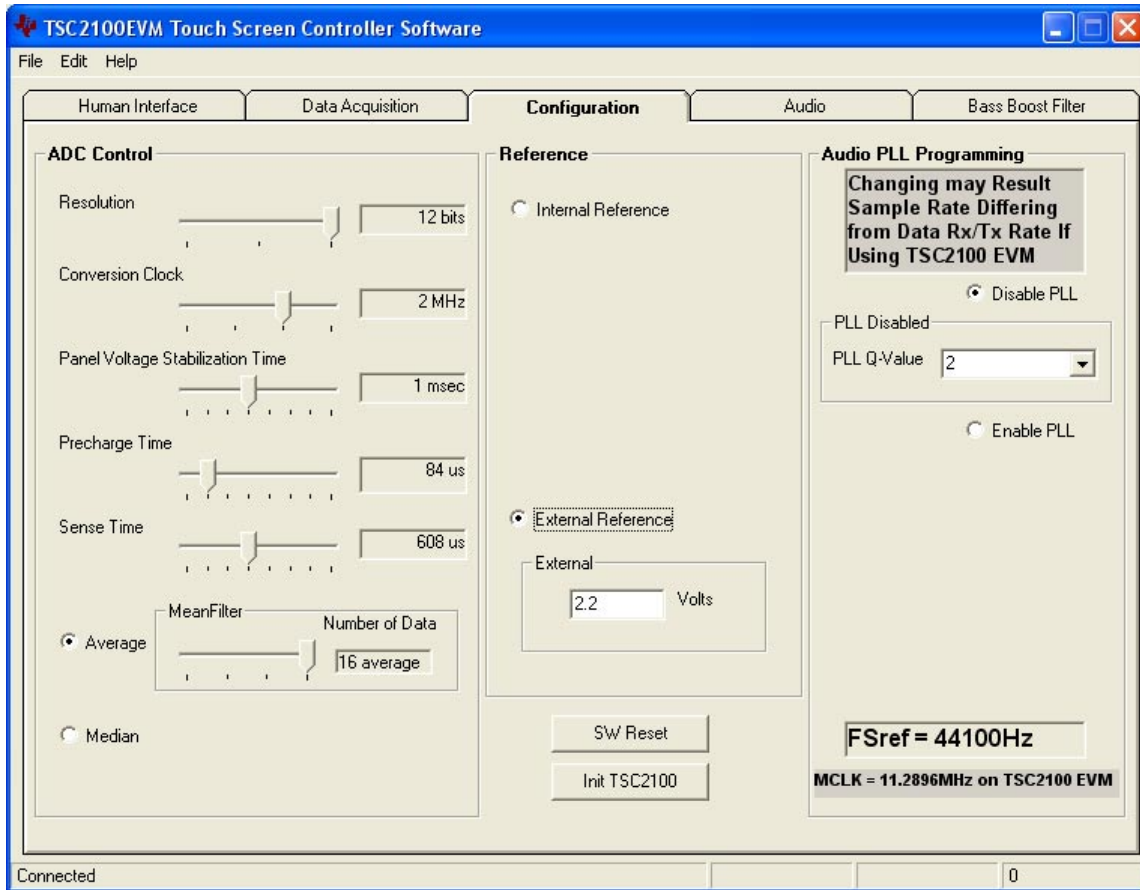

3.5.3.3 Audio PLL Section

On the audio codec part of the TSC2100, there is an on-chip phase-lock-loop (PLL). The PLL can be enabled or disabled, based on the given master clock (MCLK) to the TSC2100 and the required reference frequency (FSref) for the codec. For more details on the PLL, refer to the TSC2100 data sheet.

With the EVM board, the MCLK is at 11.2896 MHz, and the codec sample rate is also fixed at 44.1 kHz. So no PLL is necessary.

CAUTION

With the TSC2100EVM, changing the PLL setting may cause audio distortions.

3.5.3.4 Reinitialization and Reset

There are two buttons on this screen that allow the user to reset and reinitialize the TSC2100 by clicking these buttons.

By clicking the button **SW Reset**, a software reset is issued. By clicking the button **Int TSC2100**, the control registers (for ADC and audio) revert back to the startup (firmware) default settings.

To bring the TSC2100 EVM back to its powerup status, you can clicking **SW Reset** and followed by **Int TSC2100**.

3.5.4 Audio Screen

The audio functions of the TSC2100 can be accessed using the Audio screen (besides the programmable PLL which is on the configuration screen) as shown in Figure 3–8.

Figure 3–8. Audio Screen

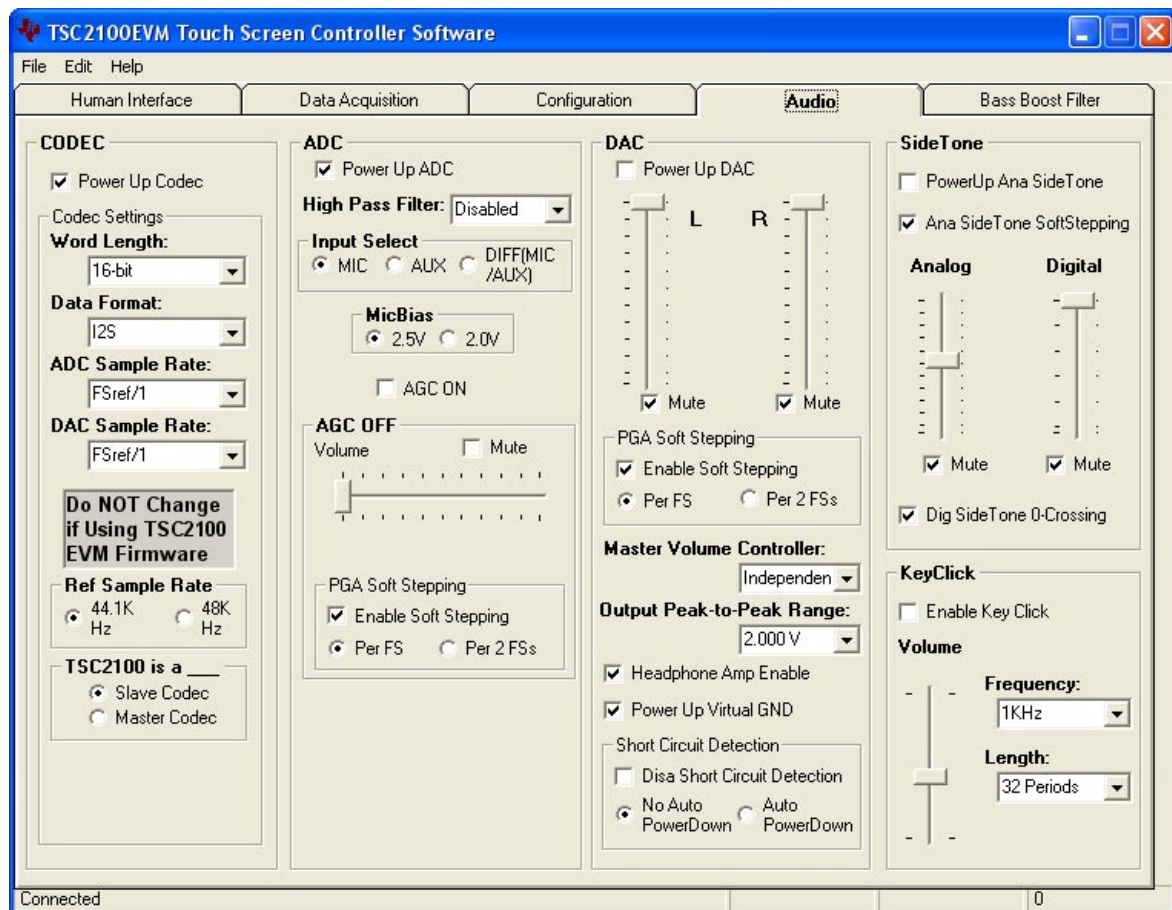

3.5.4.1 Codec Section

By checking Power Up Codec in the codec section, the audio codec is powered up.

In this EVM, the audio codec samples at 44.1 kHz in 16-bit I²S mode. Also, the TSC2100 codec functions as a slave in the interface. Although the TSC2100 device has much more flexibility, this EVM has these values fixed.

3.5.4.2 ADC Section

By checking Power Up ADC, audio ADC power is enabled.

The audio ADC also has a high-pass filter which is a submultiple of the sample rate, to remove dc or low frequency components from the input signal.

The input signal to the audio ADC can come from: 1) the pin MICIN, a single-ended input; 2) the pin AUX, also a single-ended input; or 3) the pin MIC2IN and AUX, a differential input, selectable through the Input Select box. Figure 3–8 shows the single-ended input from MICIN (if selected).

A microphone bias voltage of either 2.5 V or 2.0 V can also be generated by the TSC2100 (refer to Figure 3–8). Note that to use the microphone bias voltage, jumper JMP2 should be set to position 2 to 3 (refer to Table 3–1 of this document for jumper settings).

If the differential microphone inputs to the EVM (through the microphone jack J5) the JMP1 should be installed, and the input select should be set to DIFF (MIC/AUX) in this section.

In the ADC input path, there is a programmable EVM amplifier (ADC PGA), allowing analog input gain control from 0 dB to 59 dB. When not using automatic gain control (AGC OFF), moving the volume slide adjusts the PGA and checking the Mute box mutes the ADC signal.

When the gain changes from the current value to the programmed value, it changes in steps of 0.5 dB. Also, the change rate can be controlled if the PGA Soft Stepping box is checked, where the PGA changes 0.5 dB at either 1 step per sample or 1 step per 2 samples.

Automatic gain control (AGC) is another more sophisticated way to control the ADC gain. When the box by AGC ON is checked, AGC is enabled, as shown in Figure 3–9. Refer to the TSC 2100 data sheet for setting and using the AGC.

Figure 3–9. Audio Screen With AGC On

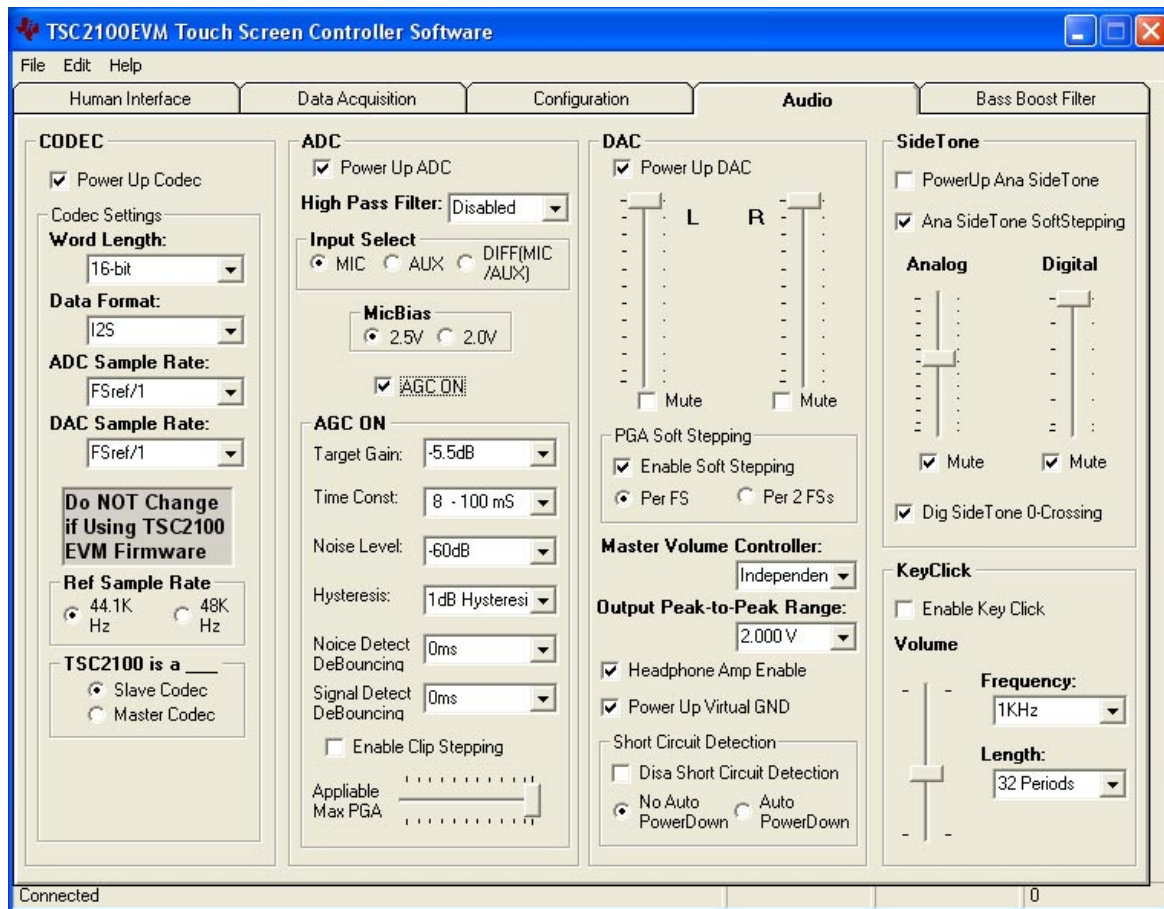

3.5.4.3 DAC Section

Like the ADC section, the TSC2100 audio DAC can be powered on or off. The stereo audio volumes can be controlled by the left (L) and right (R) volume control slides, in three different ways, selectable through setting the master volume controller: 1) independent, 2) right channel controlled, or 3) left channel controlled.

Like the audio ADC's gain controls the DAC's PGA gain can be changed in *soft stepping* either 0.5-dB per one sample, or 0.5-dB per 2 samples.

The audio DACs output swing range can be set from the list in the Output Peak-to-Peak Range pulldown. Refer to the TSC2100 data sheet to find out the range. Note that the output peak-to-peak range is related to the analog driver power supply voltage.

By checking the Headphone Amp Enable box, the amp is enabled, which can directly be connected to a 16- Ω load. Otherwise, the headphone driver is bypassed and the device can have a load of 10 k Ω .

By checking the Power Up Virtual GND box, the virtual ground for the headphone output is powered up.

3.5.4.4 Sidetone Section

The TSC2100 has an analog sidetone and a digital sidetone circuit. The audio output of the TSC2100 includes a mix of the DAC and the sidetone channels, in proportion to their respective volume settings.

The analog sidetone is enabled when the PowerUp AnaSideTone box is checked, and available only if the single-ended MICIN or AUX Input Select is selected as input to the ADC. Its volume can be adjusted by the analog volume control slider, ranging from 12 dB to -34.5 dB in 0.5-dB steps. The analog sidetone is muted when the Mute box under the slider is checked. Additionally, similar to the audio ADC and DAC, the analog sidetone volume change can be in soft stepping mode if the corresponding box is checked.

The TSC2100's digital sidetone has three settings. The volume is controlled by the digital slider, which changes from 0 dB to -48 dB in steps of 1.5 dB. The digital sidetone can be muted by checking the mute box under the volume control slider. The gain change is implemented with zero crossover, when enabled by checking the box below the sliders, and a possible pop sound may be avoided or reduced.

3.5.4.5 Keyclick Section

When the Enable Key Click box is checked, a clicking sound is heard whenever an audio related setting is selected or checked in the audio screen or in the PLL section of the configuration screen, or the bass boost filter and de-emphasizing filter are selected in the Base Boost Filter screen (see Figure 3-10).

The volume, frequency, and duration (length) of this keyclick can be adjusted using the corresponding slider and selectors shown in Figure 3-9.

3.5.5 Bass Boost Filter Screen

The Bass Boost Filter screen displays all of the coefficients for the bass boost filter function of the TSC2100, plus the Deemphasis Filter On enable box. These coefficients are programmable. This screen is shown in Figure 3-10.

Figure 3–10. Bass Boost Filter Screen

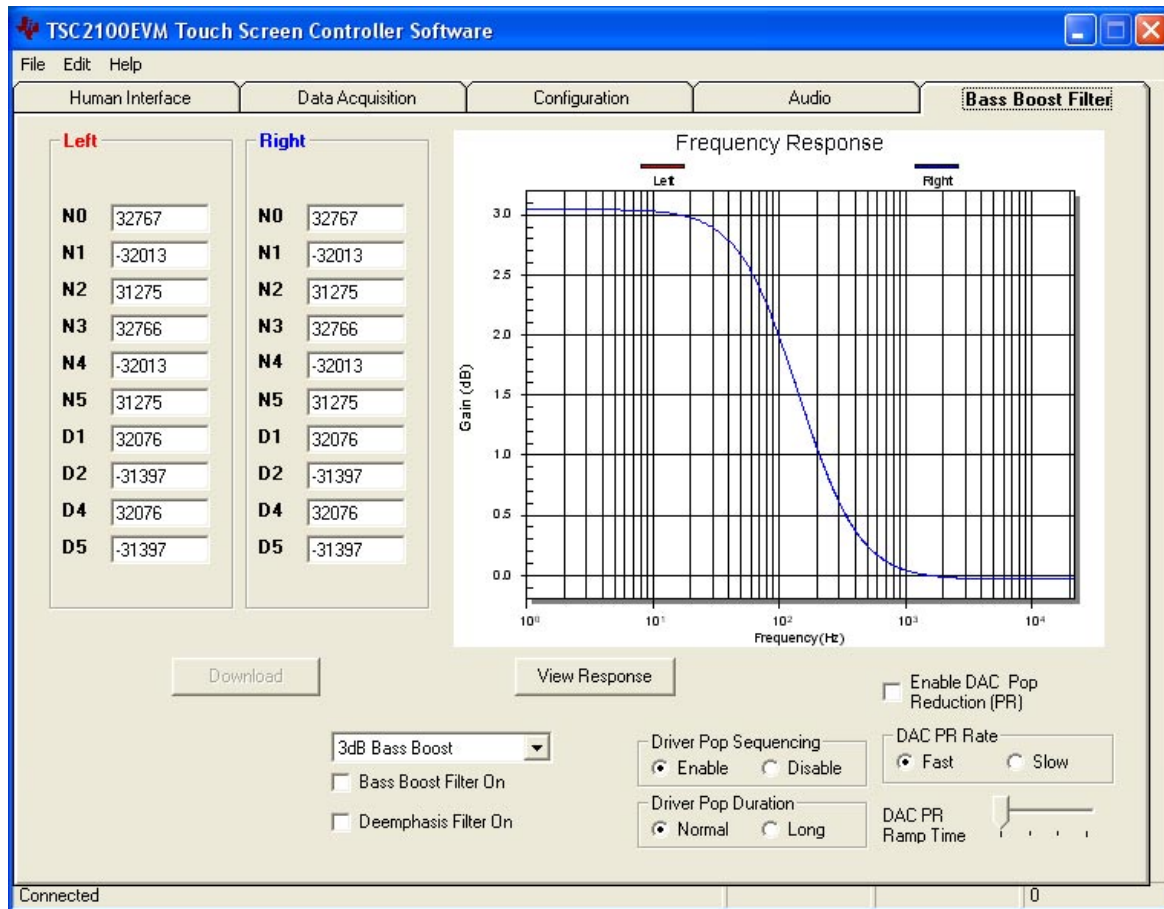

Different filter coefficients can be loaded for left and right channels, though usually these are set the same. Five *preconfigured* filters are selectable using the drop-down list box of this screen. Selecting one of these updates the coefficients and causes the graph of the filter response to update. However, nothing is loaded into the TSC2100 until the *Download* button is pressed.

If changes are made to coefficient values directly, the response can be viewed on the graph by pressing the *View Response* button. It is recommended that you view the response before downloading values to the TSC2100, as some values can cause clipping or oscillation of the filter. The filter equation is described in the TSC2100 data sheet.

Checking the Bass Boost Filter box enables the filter.

There is another digital filter, the de-emphasis filter, provided by the TSC2100 for the audio DAC. Checking the Deemphasis Filter On box enables the filter.

Moreover, to reduce the TSC2100's power-up pop noise, two pop-reduction functions were added to the TSC2100 and are selectable on this screen. They are the audio output driver pop-reduction and the audio DAC pop-reduction. Refer to the data sheet for the details of the pop-reduction features.



THIS PAGE INTENTIONALLY LEFT BLANK

Physical Description

This chapter contains the component locations, bill of materials, and the schematics.

Topic	Page
4.1 Component Locations	4-2
4.2 Bill of Materials	4-3
4.3 Schematics	4-6

4.1 Component Locations

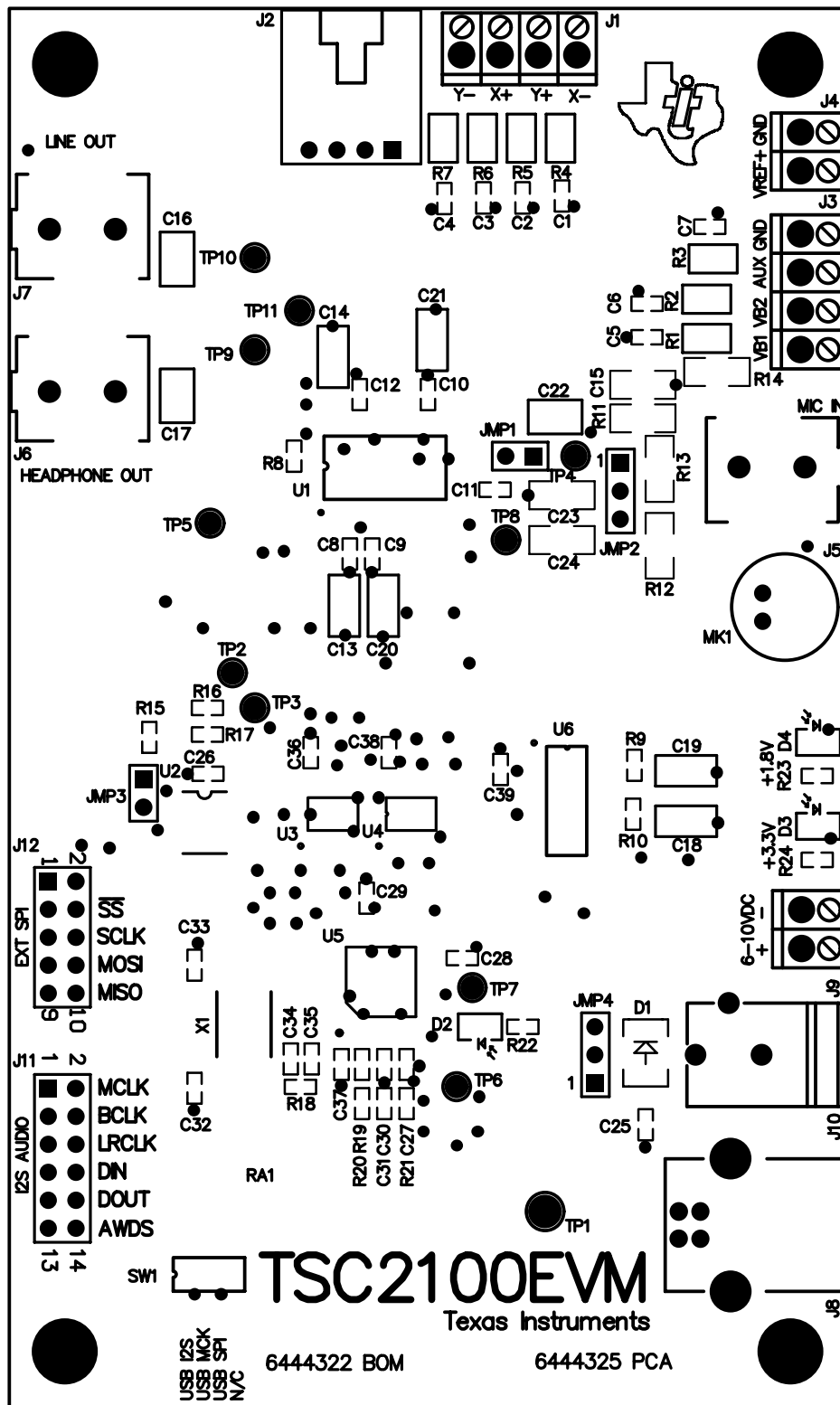

4.2 Bill of Materials

Item No.	Qty	Value	Ref Des	Description	Vendor	Part number
1	7	0R0	R1, R2, R3, R4, R5, R6, R7	1/10W 5% Chip resistor	Panasonic	ERJ-6GEY0R00V
2	1	0R0	R12	1/4W 5% Chip resistor	Panasonic	ERJ-8GEY0R00V
3	1	10R	R23	1/16W 5% Chip resistor	Panasonic	ERJ-3GEYJ100V
4	2	27R4	R20, R21	1/16W 1% Chip resistor	Panasonic	ERJ-3EKF27R4V
5	1	220R	R24	1/16W 5% Chip resistor	Panasonic	ERJ-3GEYJ221V
6	1	649R	R22	1/16W 1% Chip resistor	Panasonic	ERJ-3EKF6490V
7	1	680R	R14	1/4W 5% Chip resistor	Panasonic	ERJ-8GEYJ681V
8	1	1.5 K	R19	1/16W 5% Chip resistor	Panasonic	ERJ-3GEYJ152V
9	1	2.2 K	R13	1/4W 5% Chip resistor	Panasonic	ERJ-8GEYJ222V
10	4	3.09 K	R15, R16, R17, R18	1/16W 1% Chip resistor	Panasonic	ERJ-3EKF3091V
11	3	100 K	R8, R9, R10	1/16W 5% Chip resistor	Panasonic	ERJ-3GEYJ104V
Not Installed	1		R11	1/10W 5% Chip resistor	Panasonic	
12	1	10 K	RA1	1/8W Quad Isolated resistor array	CTS Corporation	744C083103JTR
13	2	33 pF	C32, C33	50 V Ceramic chip capacitor, $\pm 5\%$, NPO	Panasonic	ECJ-1VC1H330J
14	2	47 pF	C30, C31	50 V Ceramic chip capacitor, $\pm 5\%$, NPO	Panasonic	ECJ-1VC1H470J
15	1	100 pF	C34	50 V Ceramic chip capacitor, $\pm 5\%$, NPO	Panasonic	ECJ-1VC1H101J
16	1	1000 pF	C35	50 V Ceramic chip capacitor, $\pm 5\%$, NPO	Panasonic	ECJ-1VC1H102J
Not Installed	3	0.01 μ F	C1, C2, C3	16 V Ceramic chip capacitor, $\pm 10\%$, X7R	Panasonic	ECJ-1VB1C103K
17	1	0.01 μ F	C4	16 V Ceramic chip capacitor, $\pm 10\%$, X7R	Panasonic	ECJ-1VB1C103K
18	6	0.1 μ F	C8, C9, C10, C11, C12, C25	16 V Ceramic chip capacitor, $\pm 10\%$, X7R	Panasonic	ECJ-1VB1C104K
19	1	0.1 μ F	C24	16 V Ceramic chip capacitor, $\pm 10\%$, X7R	Panasonic	ECJ-3VB1C104K
Not Installed	3	0.1 μ F	C5, C6, C7	16 V Ceramic chip capacitor, $\pm 10\%$, X7R	Panasonic	ECJ-1VB1C104K
20	1	0.33 μ F	C39	6.3 V Ceramic chip capacitor, $\pm 10\%$, X5R	Panasonic	ECJ-1VB0J334K
21	7	1 μ F	C26, C27, C28, C29, C36, C37, C38	6.3 V Ceramic chip capacitor, $\pm 10\%$, X5R	Panasonic	ECJ-1VB0J105K

Bill of Materials

Item No.	Qty	Value	Ref Des	Description	Vendor	Part number
22	7	10 μ F	C13, C14, C15, C18, C19, C20, C21	6.3 V Ceramic chip capacitor, \pm 10%, X5R	Panasonic	ECJ-3YB0J106K
23	2	47 μ F	C16, C17	6.3 V Ceramic chip capacitor, \pm 20%, X5R	Panasonic	ECJ-4YB0J107K
24	1	47 μ F	C22	16 V Ceramic chip capacitor, \pm 10%, X7R	Panasonic	
Not Installed	1	100 μ F	C23	6.3 V Ceramic chip capacitor, \pm 20%, X5R	Panasonic	ECJ-4YB0J107M
25	1		D1	50 V, 1A, Diode MELF SMD	Micro Commercial Components	DL4001
26	1		D2	Yellow light emitting diode	Lumex	SML-LX0603YW-TR
27	1		D3	Green light emitting diode	Lumex	SML-LX0603GW-TR
28	1		D4	Red light emitting diode	Lumex	SML-LX0603IW-TR
29	1		MK1	Omnidirectional Microphone Cartridge	Knowles Acoustics	MD9745APZ-F
30	1		X1	6 MHz Crystal SMD	Epson	MA-505 6.000M-C0
31	1		U1	Touch screen controller, audio CODEC	Texas Instruments	TSC2100IDA
32	1		U5	USB streaming controller	Texas Instruments	TAS1020BPFB
33	1		U6	3.3 V/1.8 V dual output LDO regulator	Texas Instruments	TPS767D318PWP
34	2		U3, U4	Quad 3-state buffers	Texas Instruments	SN74LVC125APW
35	1		U2	64 K 2-wire serial EEPROM I ² C	Microchip	24LC64I/SN
36	1		N/A	TSC2100EVM PWB	Texas Instruments	6444324
37	10		TP2, TP3, TP4, TP5, TP6, TP7, TP8, TP9, TP10, TP11	Miniature test point terminal	Keystone Electronics	5000
38	1		TP1	Multipurpose test point terminal	Keystone Electronics	5011
39	1		J2	4 Pin right angle latching header	Tyco Electronics/A MP	103634-3
40	1		J8	USB Type B slave connector thru-hole	Mill-Max	897-30-004-90-000000
41	2		J4, J9	2 Position terminal block	On Shore Technology	ED555/2DS
42	2		J1, J3	4 Position terminal block	On Shore Technology	ED555/4DS
43	1		J10	2,5 mm Power connector	CUI Stack	PJ-102B

Item No.	Qty	Value	Ref Des	Description	Vendor	Part number
44	3		J5, J6, J7	3,5 mm Stereo audio jack SMT	CUI Stack	SJ-3515-SMT-1
45	1		J12	10 Pin double row header (2x5) 0.1"	Samtec	TSW-105-07-L-D
46	1		J11	12 Pin double row header (2x6) 0.1"	Samtec	TSW-106-07-L-D
47	2		JMP1, JMP3	2 Position Jumper , 0.1" spacing	Samtec	TSW-102-07-L-S
48	2		JMP2, JMP4	3 Position Jumper , 0.1" spacing	Samtec	TSW-103-07-L-S
49	1		SW1	SMT, Half-pitch 4 position switch	C & K Division, ITT	TDA04H0SK1
50	4		N/A	Jumper plug	Samtec	SNT-100-BK-T
51	4		N/A	0.25" x 0.625" Hex 4-40 threaded standoff	Keystone Electronics	1808
52	4		N/A	Pan head machine screw 4-40 x 1/2" Phillips	Building Fasteners	PMS 440 0050 PH

4.3 Schematics

Schematic diagrams of the TSC2100EVM showing the TSC2100 connections and the USB and connectors are shown on the following pages.

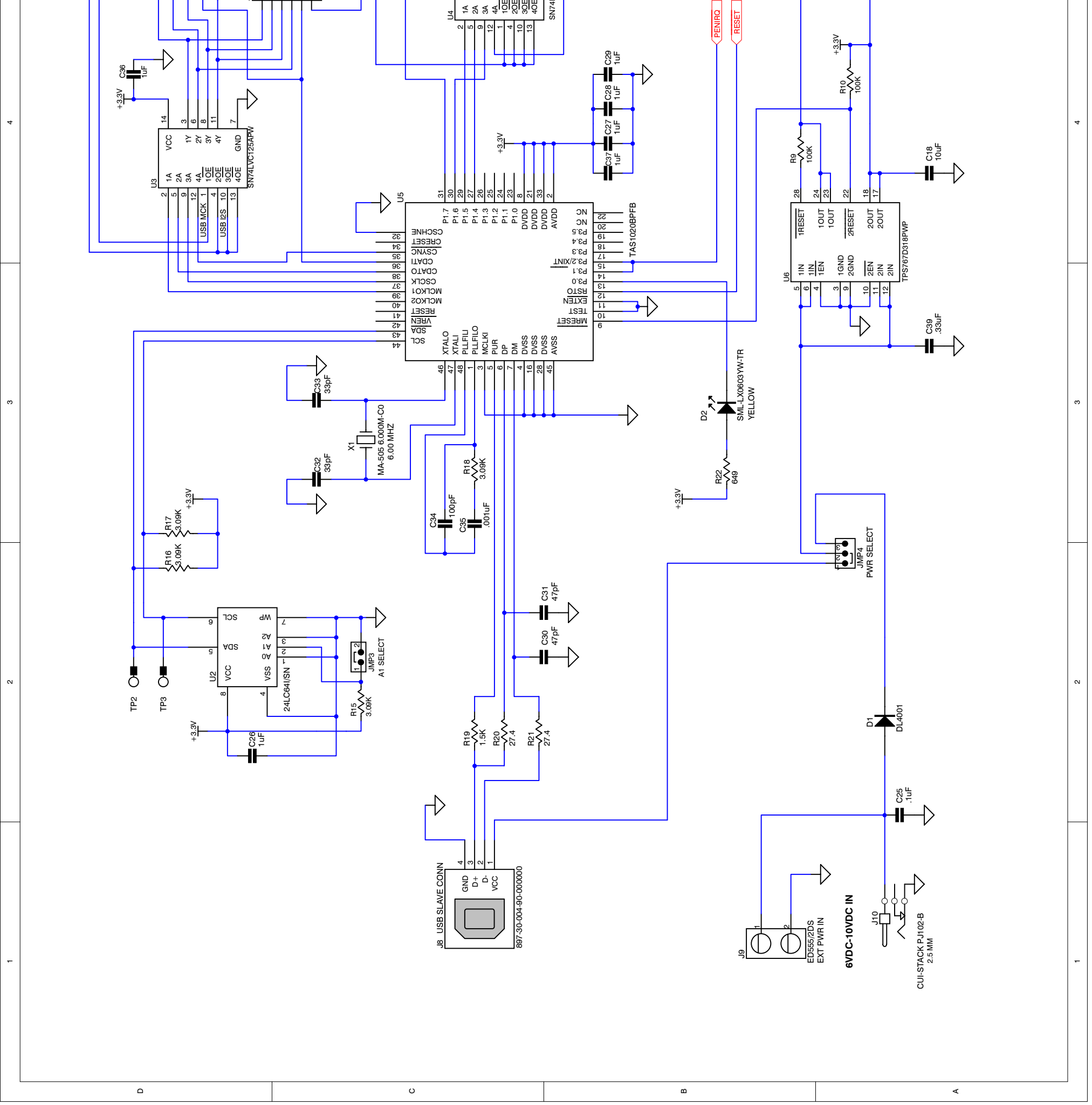

1

2

3

4

D

C

B

A

1

2

3

4

Looking for pricing, stock, or lifecycle information?

Click below to explore more details on WIN SOURCE:

 [View TSC2100EVM](#) on WIN SOURCE

 [Texas Instruments](#) Information

Optimize Your Supply Chain with WIN SOURCE Solutions

-  Global Sourcing Solution
-  Obsolete Management
-  Cost Control Management
-  Shortage Management
-  Alternative Solution
-  Excess Inventory Management