



**THE DATASHEET OF
TPS55340EVM-017**



TPS55340EVM-017, 5-V to 12-V Input, 24-V Output Boost Evaluation Module

This user's guide contains information for the TPS55340EVM-017 evaluation module (EVM) as well as the TPS55340 DC/DC converter. The document includes the performance specifications, schematic, and the bill of materials for the TPS55340EVM-017.

Contents

1	Background	2
2	Performance Specification Summary	2
3	Modifications.....	3
4	Test Setup and Results	3
5	Board Layout.....	12
6	Schematic and Bill of Materials.....	15

List of Figures

1	TPS55340EVM-017 Efficiency	4
2	TPS55340EVM-017 Output Voltage Load Regulation	5
3	TPS55340EVM-017 Output Voltage Line Regulation	5
4	TPS55340EVM-017 $V_{IN} = 5\text{-V}$ Transient Response	6
5	TPS55340EVM-017 $V_{IN} = 12\text{-V}$ Transient Response	6
6	TPS55340EVM-017 Loop Response	7
7	TPS55340EVM-017 $V_{IN} = 5\text{-V}$ Output Ripple	7
8	TPS55340EVM-017 $V_{IN} = 12\text{-V}$ Output Ripple	8
9	TPS55340EVM-017 DCM Output Ripple	8
10	TPS55340EVM-017 $V_{IN} = 12\text{-V}$ Pulse-Skipping	9
11	TPS55340EVM-017 $V_{IN} = 5\text{-V}$ Input Voltage Ripple	9
12	TPS55340EVM-017 $V_{IN} = 12\text{-V}$ Input Voltage Ripple	10
13	TPS55340EVM-017 Power Up With EN	10
14	TPS55340EVM-017 Power Down With EN	11
15	TPS55340EVM-017 Power Up With V_{IN}	11
16	TPS55340EVM-017 Power Down With V_{IN}	12
17	TPS55340EVM-017 Top-Side Assembly	13
18	TPS55340EVM-017 Top-Side Layout	13
19	TPS55340EVM-017 Internal Layer-1 Layout	14
20	TPS55340EVM-017 Internal Layer-2 Layout	14
21	TPS55340EVM-017 Bottom-Side Layout	15
22	TPS55340EVM-017 Schematic	15

⁽¹⁾ All trademarks are the property of their respective owners.

1 Background

The TPS55340 DC/DC converter is a step-up boost converter. Rated input voltage and output current range for the evaluation module are given in [Table 1](#). This EVM demonstrates the performance of the TPS55340 in an example application and accommodates evaluation of other boost applications supported by the TPS55340. This design shows that a small printed-circuit-board area is possible when designing with the TPS55340 regulator. However, appropriate sizing of the inductor and diode for the desired application can further reduce the board area. The switching frequency is externally set at a nominal 600 kHz. The 40-V, 5-A, low-side MOSFET is incorporated inside the TPS55340 package along with the gate-drive circuitry. The low drain-to-source on-resistance of the MOSFET achieves high efficiencies with the TPS55340. The compensation components are external to the integrated circuit (IC). The absolute maximum input voltage is 32 V for the EVM.

Table 1. Input Voltage and Output Current Summary

EVM	Input Voltage Range	Maximum Output Current
TPS55340EVM-017	$V_{IN} = 5\text{ V to }12\text{ V}$	$I_{OUT,max} = 800\text{ mA } (V_{IN} = 5\text{ V}) \text{ to } 1.9\text{ A } (V_{IN} = 12\text{ V})$

2 Performance Specification Summary

[Table 2](#) provides a summary of the EVM performance specifications. Specifications are given for an input voltage of $V_{IN} = 5\text{ V}$ and $V_{IN} = 12\text{ V}$ with an output voltage of 24 V, unless otherwise specified. The ambient temperature is 25°C for all measurements, unless otherwise noted.

Table 2. Performance Specification Summary

Specification	Test Conditions		Min	Typ	Max	Unit
V_{IN} voltage range			5		12	V
Output voltage set point				24		V
Line regulation	$I_{OUT} = 800\text{ mA}, V_{IN} = 5\text{ V to }12\text{ V}$			±1%		
Operating frequency				600		kHz
Specifications for $V_{IN} = 5.0\text{ V}$						
Output current range			1		800	mA
Load regulation	$I_{OUT} = 1\text{ mA to }800\text{ mA}$			±1%		
Load transient response	$I_{OUT} = 200\text{ mA to }600\text{ mA}$	Voltage change		-720		mV
		Recovery time		1		ms
	$I_{OUT} = 600\text{ mA to }200\text{ mA}$	Voltage change		720		mV
		Recovery time		1		ms
Loop bandwidth	$I_{OUT} = 800\text{ mA}$			5.3		kHz
Phase margin	$I_{OUT} = 800\text{ mA}$			66.5		°
Output ripple voltage	$I_{OUT} = 800\text{ mA}$			150		mVpp
Maximum efficiency	TPS55340EVM-017, $V_{IN} = 5\text{ V}, I_{OUT} = 300\text{ mA}$			92.1%		
Specifications for $V_{IN} = 12\text{ V}$						
Output current range			0.001		1.9	A
Load regulation	$I_{OUT} = 1\text{ mA to }1.9\text{ A}$			±1%		
Load transient response	$I_O = 475\text{ mA to }1.425\text{ A}$	Voltage change		-720		mV
		Recovery time		1		ms
	$I_{OUT} = 1.425\text{ A to }475\text{ mA}$	Voltage change		720		mV
		Recovery time		1		ms
Loop bandwidth	$I_{OUT} = 1.9\text{ A}$			15.6		kHz
Phase margin	$I_{OUT} = 1.9\text{ A}$			59.6		°
Output ripple voltage	$I_{OUT} = 1.9\text{ A}$			200		mVpp
Maximum efficiency	TPS55340EVM-017, $I_{OUT} = 800\text{ mA}$			95.9%		

3 Modifications

These evaluation modules provide access to the features of the TPS55340. Some modifications to this module are possible.

3.1 Output Voltage Set Point

The resistor divider network of R1 and R2 sets the output voltage. Keep R2 fixed at or close to 10 kΩ. Change the output voltage of the EVM by changing the value of resistor R1. Calculate the value of R1 for a specific output voltage by using [Equation 1](#).

$$R1 = R2 \times \left(\frac{V_{OUT}}{1.229V} - 1 \right) \quad (1)$$

Note that V_{IN} must be in a range so that the on-time is greater than the minimum controllable on-time (77 ns typical), and the maximum duty cycle is less than 89% minimum and 93% typical.

3.2 Maximum Output Current

After adjusting input or output voltage settings, verify the maximum output current pursuant to the equations given on the data sheet.

3.3 Slow-Start Time

Adjust the slow-start time by changing the value of C3. The EVM uses $C3 = 0.047 \mu\text{F}$, as recommended on the data sheet, avoiding any overshoot during start-up. A larger capacitance increases the slow-start time while a smaller capacitance decreases it.

3.4 Other Modifications

Please see data sheet recommendations and equations when changing the switching frequency, input/output voltage range, input inductor, output capacitors or compensation.

4 Test Setup and Results

This section describes how to properly connect, set up, and use the EVM. Included are test results typical for the evaluation module covering efficiency, output voltage regulation, load transients, loop response, output ripple, input ripple, start-up and shut-down.

4.1 Input/Output Connections

The EVM is provided with input and output connectors and test points as shown in [Table 3](#). Connect a power supply capable of supplying 5 A to J6 through a pair of 20 AWG wires. The jumper across JP1 in the ON position (1-2) must be in place. Connect the load to J7 through a pair of 20 AWG wires. The maximum load-current capability must be at least 1.9 A. Minimize wire lengths to reduce losses in the wires. Header J1 provides a place to monitor the V_{IN} input voltages with J3 providing a convenient ground reference. Use J2 to monitor the output voltage with J4 as the ground reference.

Table 3. EVM Connectors and Test Points

Reference Designator	Function
J1	2-pin header for V_{IN} input voltage connections
J2	2-pin header for V_{OUT} input voltage connections
J3, J4	2-pin header for GND connections
J5	2-pin header for synchronizing signal and ground
J6	V_{IN} input voltage connector. (See Table 1 for V_{IN} range.)
JP1	3-pin header for enable. Jumper installed from pins 1-2 enables and from pins 2-3 disables.
TP1	SW test point
TP2	Test point between voltage divider network and output. Used for loop-response measurements.

Table 3. EVM Connectors and Test Points (continued)

Reference Designator	Function
TP3	COMP test point
TP4	Output voltage test point at V_{OUT} connector
TP5	GND test point at V_{OUT} connector

4.2 Efficiency

The efficiency of this EVM peaks at a load current of about 300 mA at 5-V input and 800 mA at 12-V input, then decreases as the load current increases toward full load. Figure 1 shows the efficiency for the EVM at an ambient temperature of 25°C.

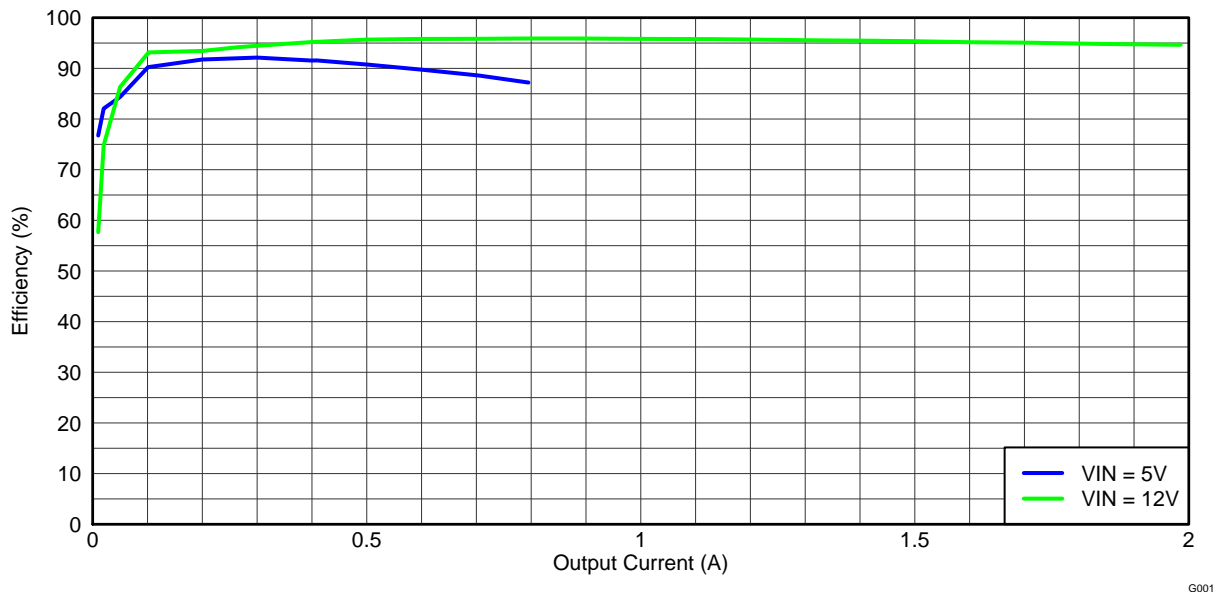
Figure 1. TPS55340EVM-017 Efficiency

The efficiency may be lower at higher ambient temperatures, due to temperature variation in the drain-to-source resistance of the internal MOSFET.

4.3 Output Voltage Load Regulation

Figure 2 shows the load regulation for the EVM.

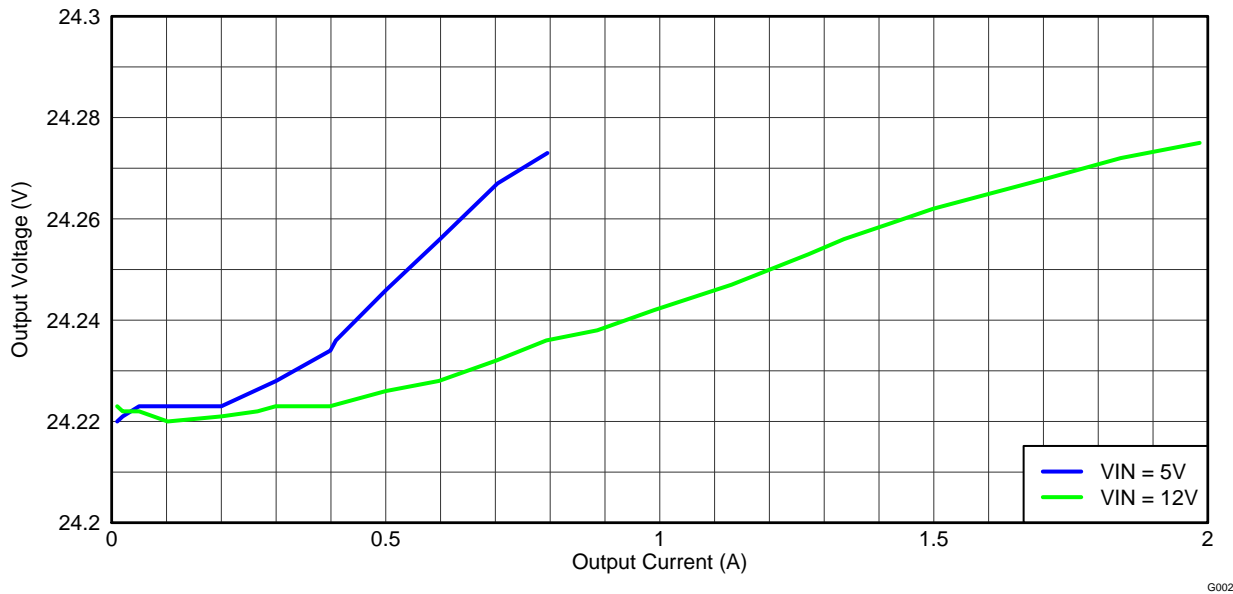

Figure 2. TPS55340EVM-017 Output Voltage Load Regulation

Measurements are for an ambient temperature of 25°C.

4.4 Output Voltage Line Regulation

Figure 3 shows the line regulation for the EVM with a 32-Ω (750-mA) load.

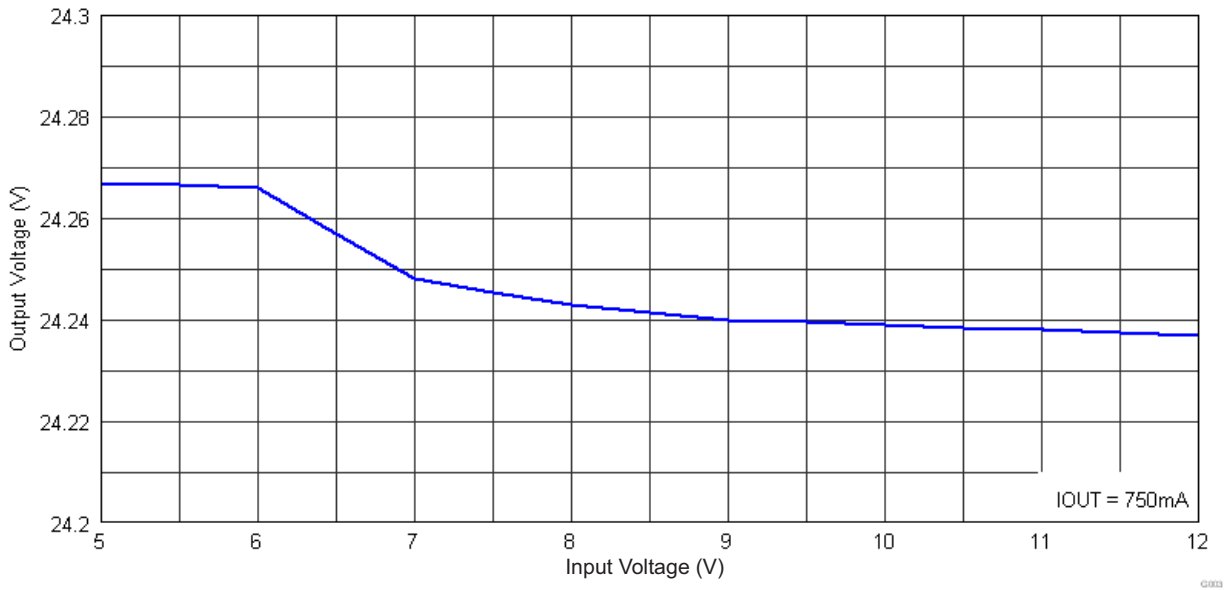

Figure 3. TPS55340EVM-017 Output Voltage Line Regulation

4.5 Load Transients

Figure 4 and Figure 5 show the EVM's response to load transients. The current step is from 25% to 75% of maximum rated load at a 5-V input and a 12-V input respectively. The current step slew rate is 10 mA/ μ s. Total peak-to-peak voltage variation is as shown, including ripple and noise on the output.

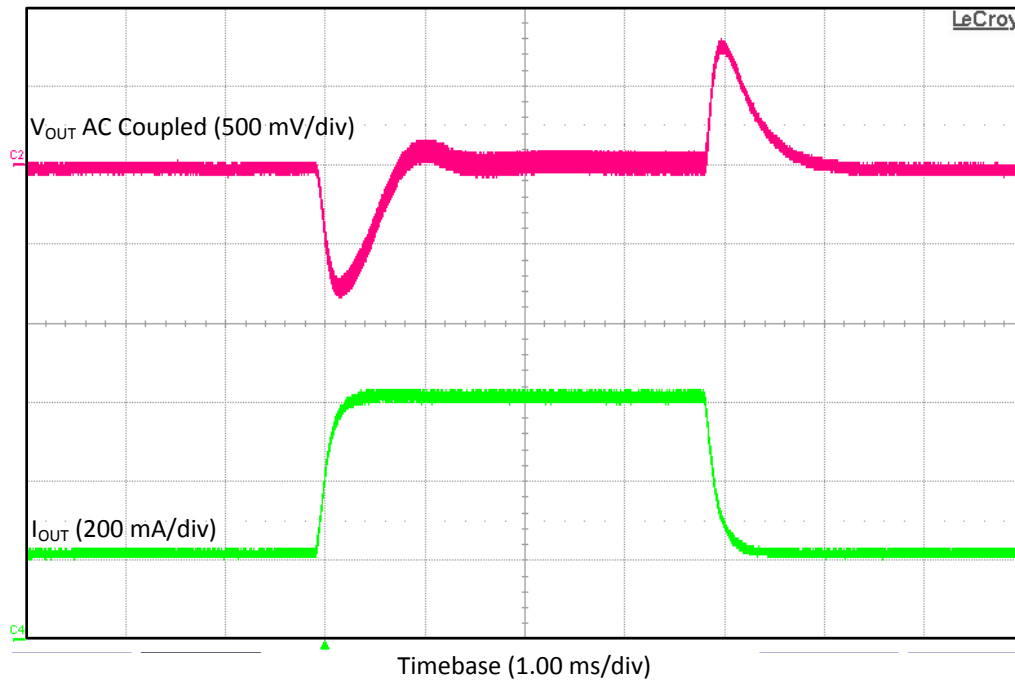

Figure 4. TPS55340EVM-017 $V_{IN} = 5\text{-V}$ Transient Response

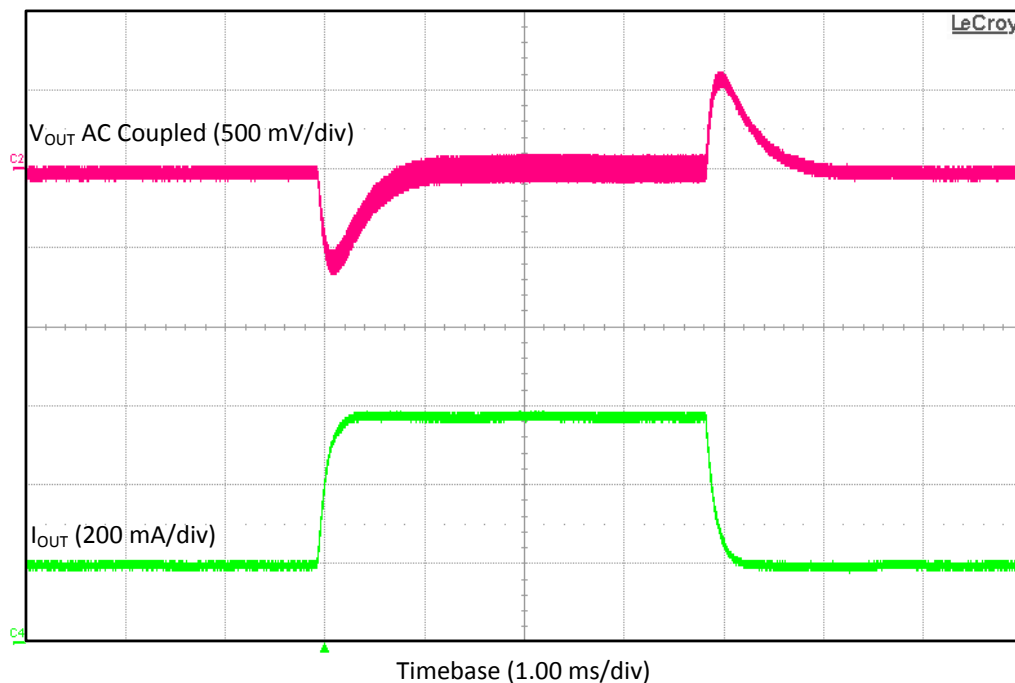

Figure 5. TPS55340EVM-017 $V_{IN} = 12\text{-V}$ Transient Response

4.6 Loop Characteristics

Figure 6 shows the EVM loop-response characteristics. Gain and phase plots are shown for V_{IN} voltages of 5 V and 12 V with load currents of 800 mA and 1.9 A, respectively.

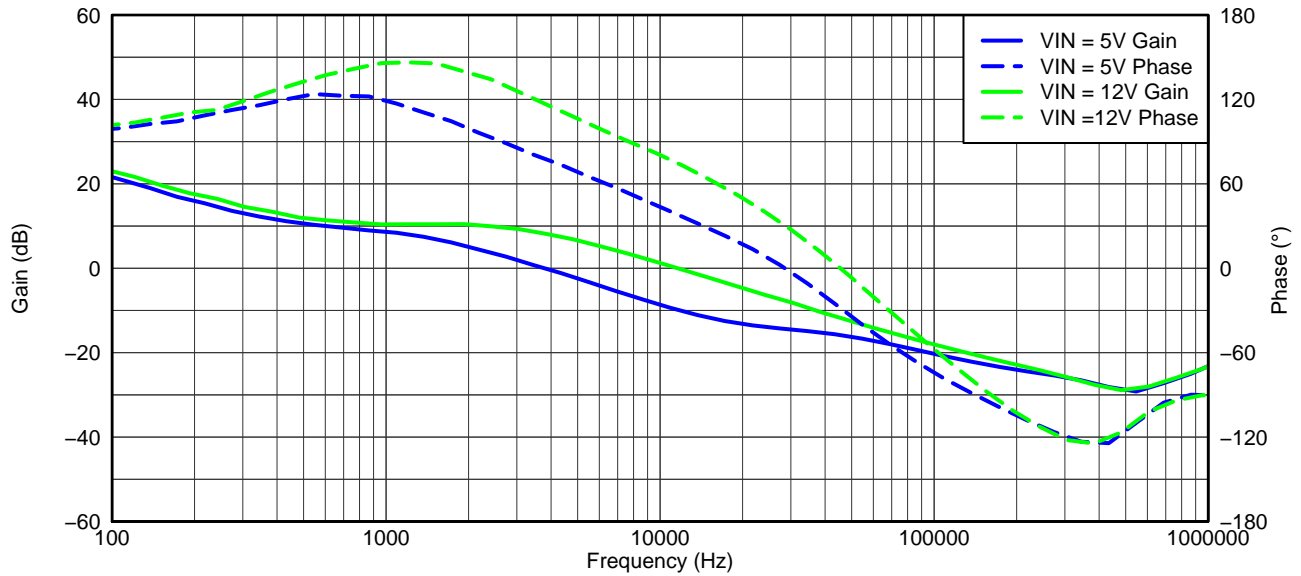

Figure 6. TPS55340EVM-017 Loop Response

G006

4.7 Output Voltage Ripple

Figure 7 shows the EVM output voltage ripple and inductor current ripple. The output current is the rated full load of 800mA and $V_{IN} = 5$ V. The ripple voltage is measured directly across the output capacitors.

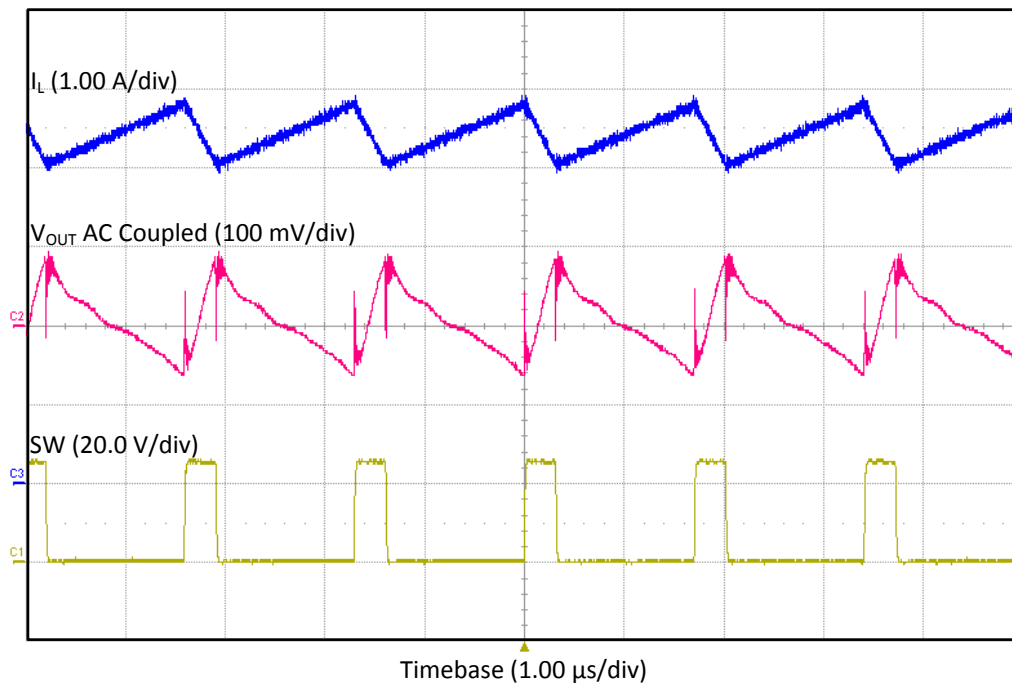

Figure 7. TPS55340EVM-017 $V_{IN} = 5$ -V Output Ripple

Figure 8 shows the EVM output voltage ripple and inductor current ripple. The output current is the rated full load of 1.9 A and $V_{IN} = 12$ V. The ripple voltage is measured directly across the output capacitors.

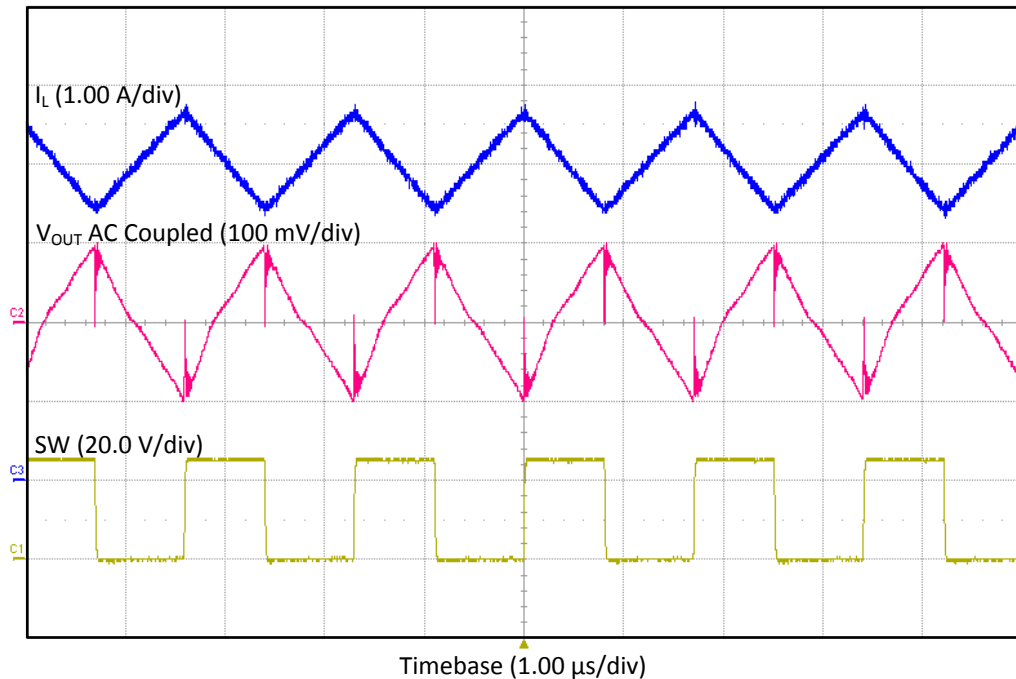

Figure 8. TPS55340EVM-017 $V_{IN} = 12$ -V Output Ripple

Figure 9 shows the EVM output voltage ripple, inductor current ripple and switching waveform while operating in discontinuous conduction mode (DCM). The input voltage is 5 V and the output is loaded with 1.2 k Ω .

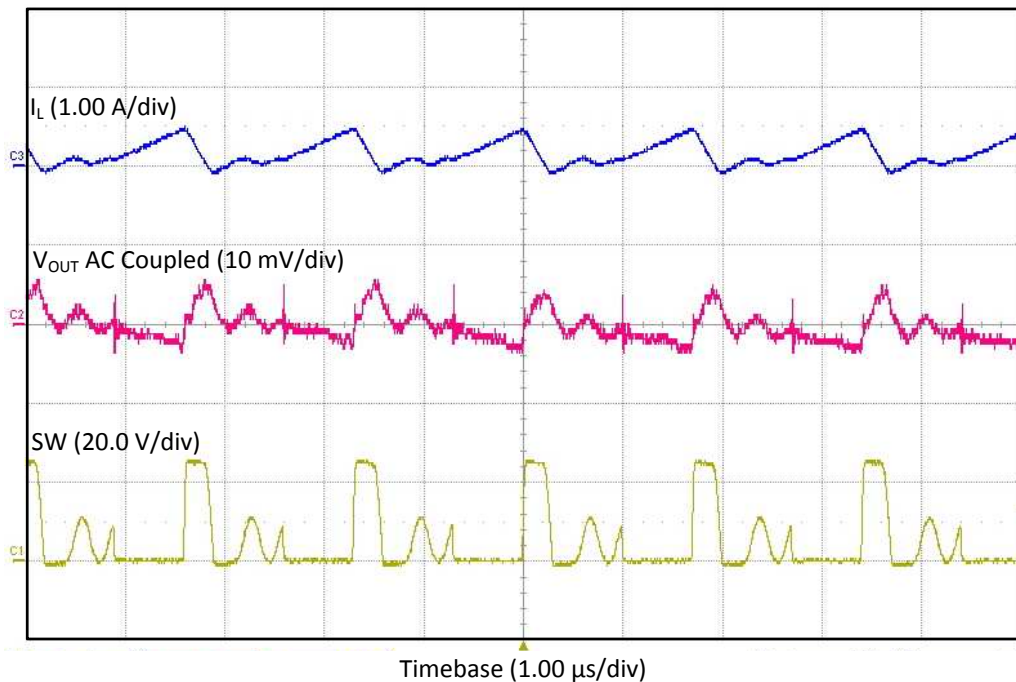

Figure 9. TPS55340EVM-017 DCM Output Ripple

4.8 Pulse-Skipping Operation

The TPS55340 features pulse-skipping for output regulation when operating at light loads. Figure 9 shows the output voltage ripple and the pulse-skipping at SW. The input voltage is 12 V.

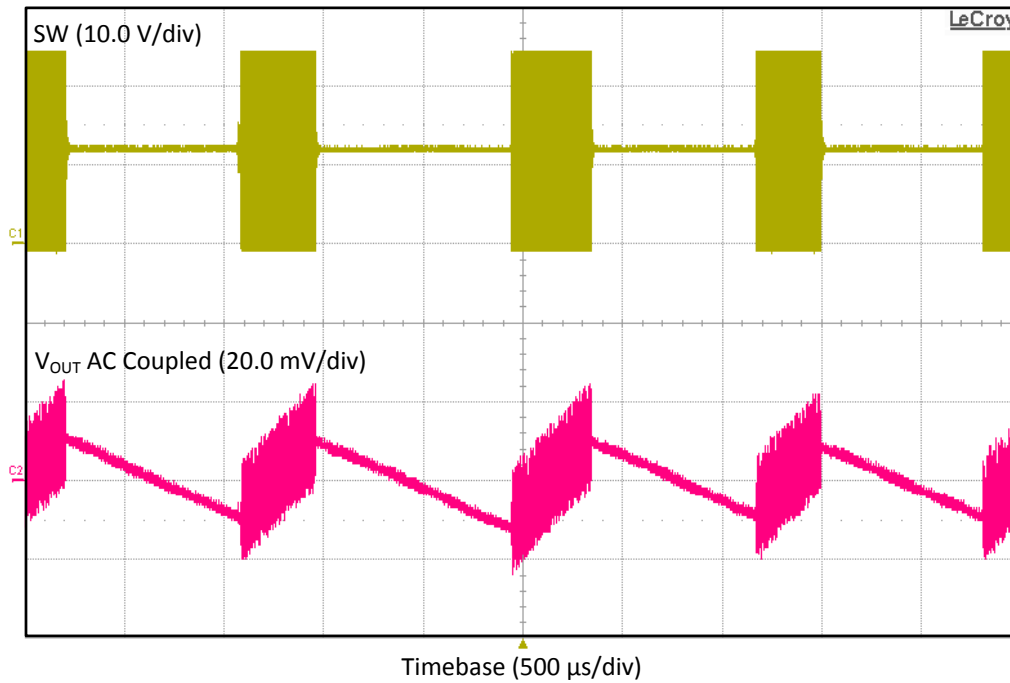

Figure 10. TPS55340EVM-017 V_{IN} = 12-V Pulse-Skipping

4.9 Input Voltage Ripple

Figure 11 shows the EVM input voltage ripple. The output current is the rated full load of 800 mA at V_{IN} = 5 V. The ripple is measured directly across the input capacitor, C2.

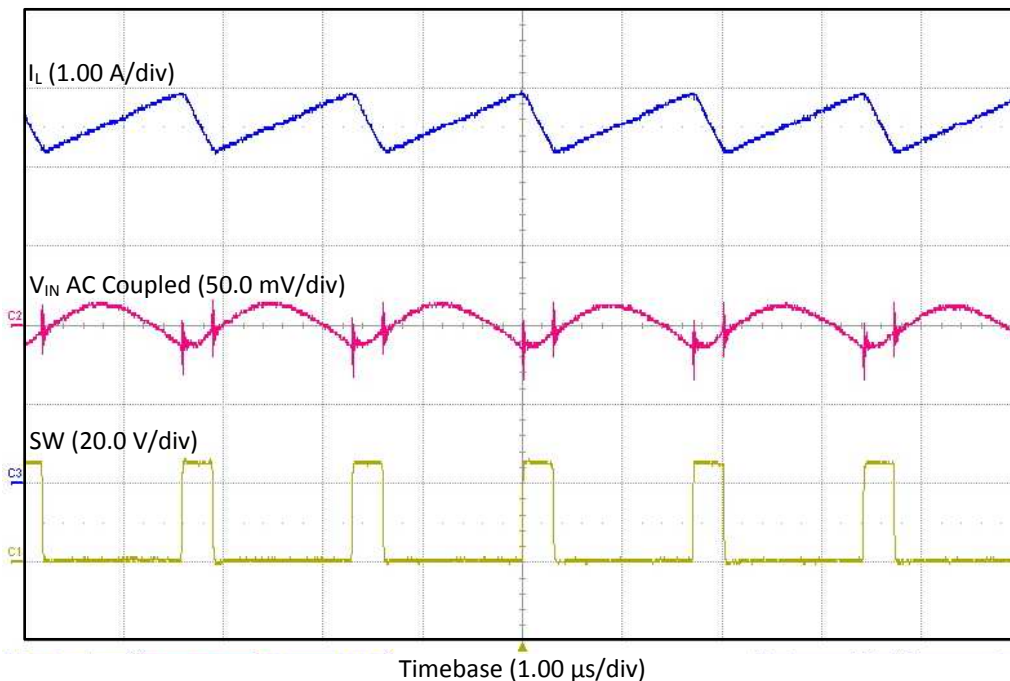

Figure 11. TPS55340EVM-017 V_{IN} = 5-V Input Voltage Ripple

Figure 12 shows the EVM input voltage ripple. The output current is the rated full load of 1.9 A at $V_{IN} = 12$ V. The ripple is measured directly across the input capacitor, C2.

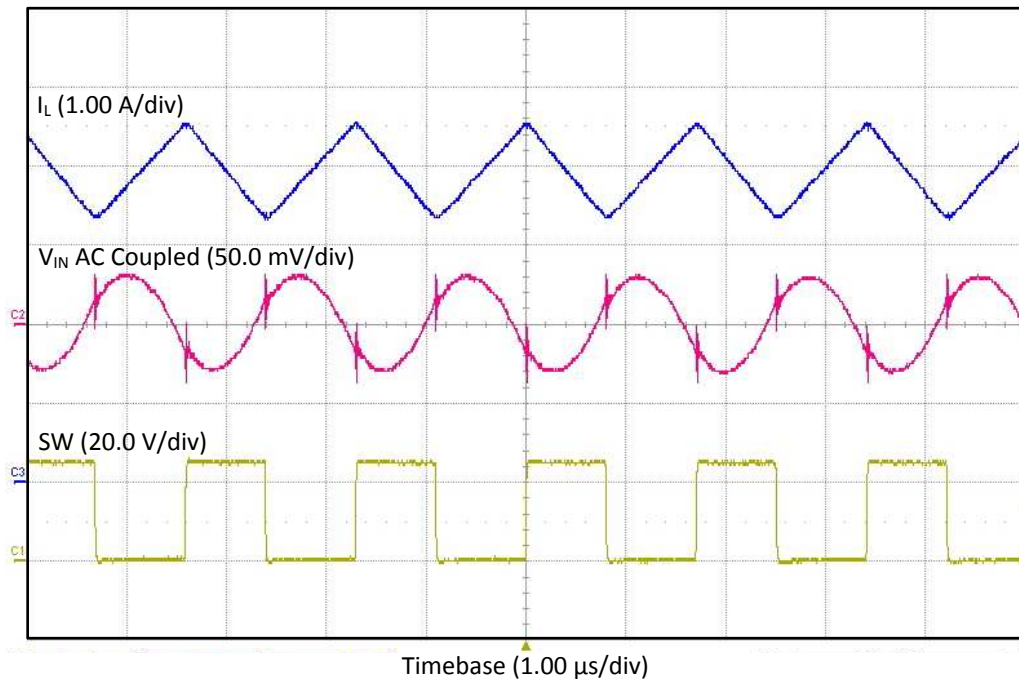

Figure 12. TPS55340EVM-017 $V_{IN} = 12$ -V Input Voltage Ripple

4.10 Powering Up and Down with EN

Figure 13 shows the start-up waveforms for the EVM. The input voltage is 5 V, the EN goes high and the output voltage ramps from V_{IN} to 24V. The load is 120 Ω .

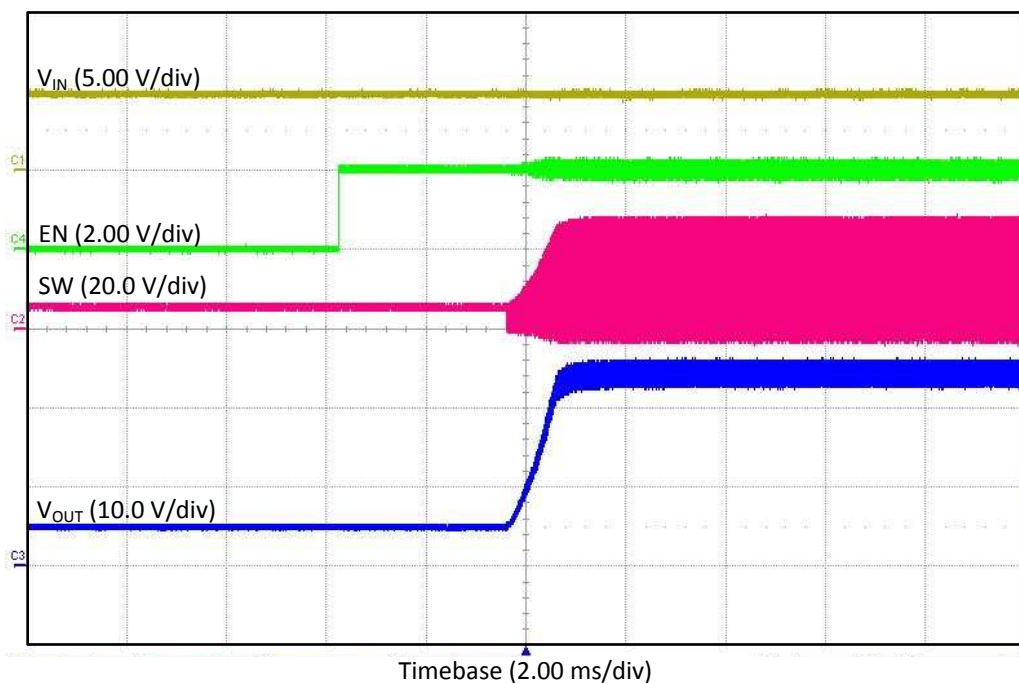

Figure 13. TPS55340EVM-017 Power Up With EN

Figure 14 shows the shutdown waveforms for the EVM. The input voltage is 5V. The EN goes low and the output voltage ramps from 24 V to V_{IN} . The load is 120 Ω .

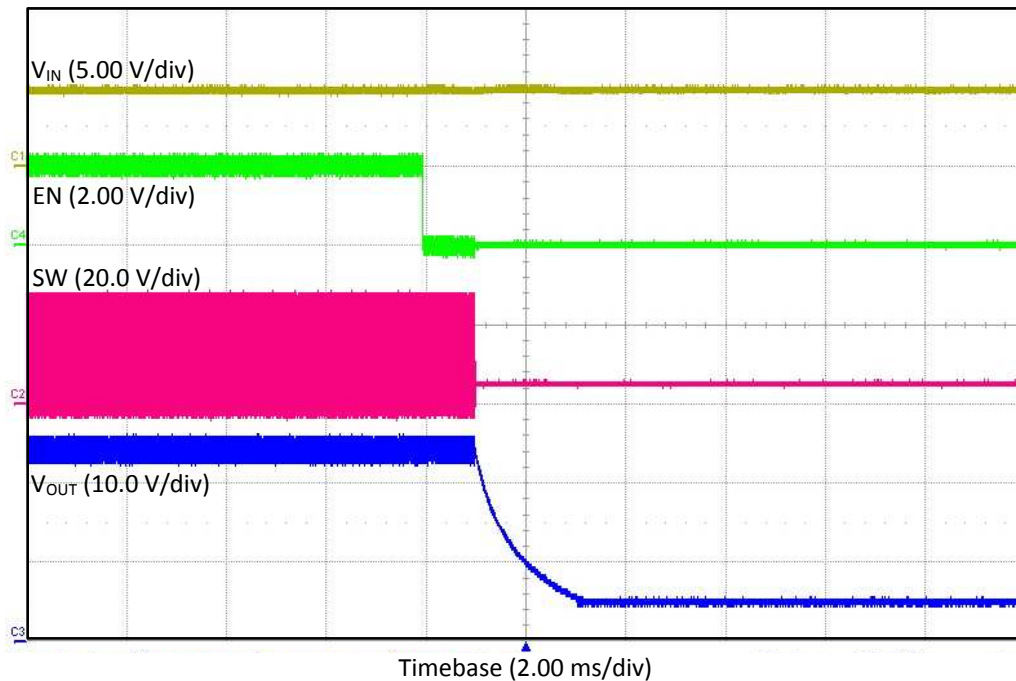

Figure 14. TPS55340EVM-017 Power Down With EN

4.11 Powering Up and Down with V_{IN}

Figure 15 shows the start-up waveforms for the EVM. The input voltage ramps with the input voltage power supply and EN is tied to V_{IN} . V_{IN} ramps up, the converter starts switching and the output voltage ramps to 24 V. The load is 120 Ω .

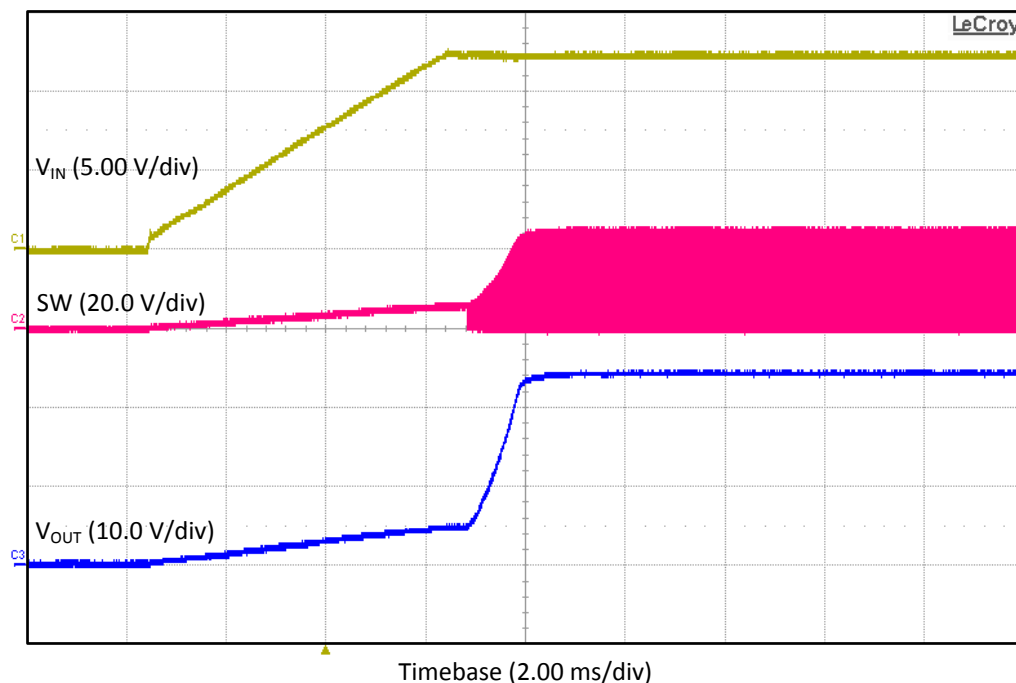

Figure 15. TPS55340EVM-017 Power Up With V_{IN}

Figure 16 shows the shutdown waveforms for the EVM. The input voltage ramps down with the input voltage power supply and EN is tied to V_{IN} . When V_{IN} is less than the 2.5-V typical UVLO, the converter stops switching and the output voltage ramps down. The load is 120 Ω .

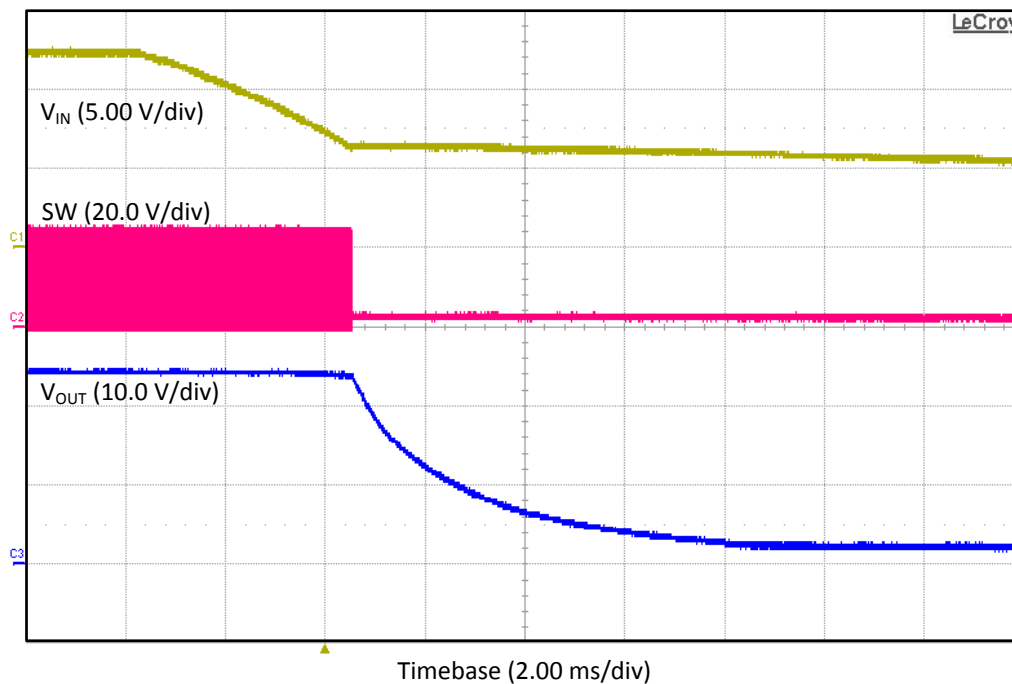

Figure 16. TPS55340EVM-017 Power Down With V_{IN}

5 Board Layout

This section provides a description of the EVM board layout and layer illustrations.

5.1 Layout

The board layout for the EVM is shown in Figure 17 through Figure 21. The top-side layer of the EVM is laid out in a manner typical of a user application. The top, bottom, and internal layers are 2-oz. copper.

The top layer contains the main power traces for V_{IN} , V_{OUT} , and SW. Also on the top layer are connections for the remaining pins of the TPS55340 and a large area filled with ground. The internal layers and bottom are primarily ground with additional fill areas for V_{IN} and V_{OUT} . The top-side ground traces connect to the bottom and internal ground planes with multiple vias placed around the board. Nine vias directly under the TPS55340 device provide a thermal path from the top-side ground plane to the bottom-side ground plane.

Place the output decoupling capacitors (C8–C11) as close to the IC as possible. The copper area of the SW node is kept small minimizing noise. The vias near the diode, D1, on the V_{OUT} plane aid with thermal dissipation. Additionally, keep the voltage setpoint resistor divider components close to the IC. The voltage divider network ties to the output voltage at the point of regulation, the copper V_{OUT} trace at the J7 output connector. For the TPS55340, an additional input bulk capacitor may be necessary, depending on the EVM connection to the input supply. Critical analog circuits such as the voltage setpoint divider, frequency set resistor, slow-start capacitor, and compensation components terminate to ground using a separate ground trace on the top and bottom connected power ground, pour only at one point directly under the IC.

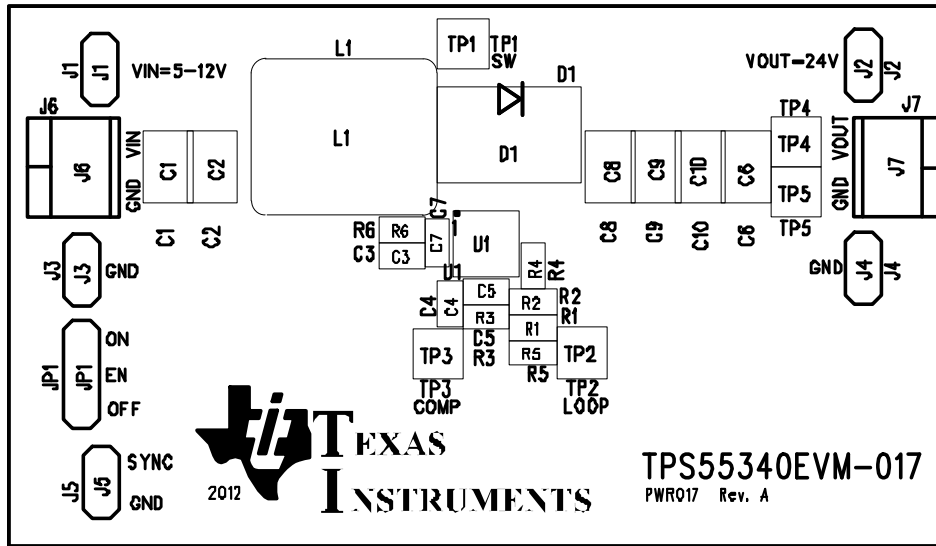

Figure 17. TPS55340EVM-017 Top-Side Assembly

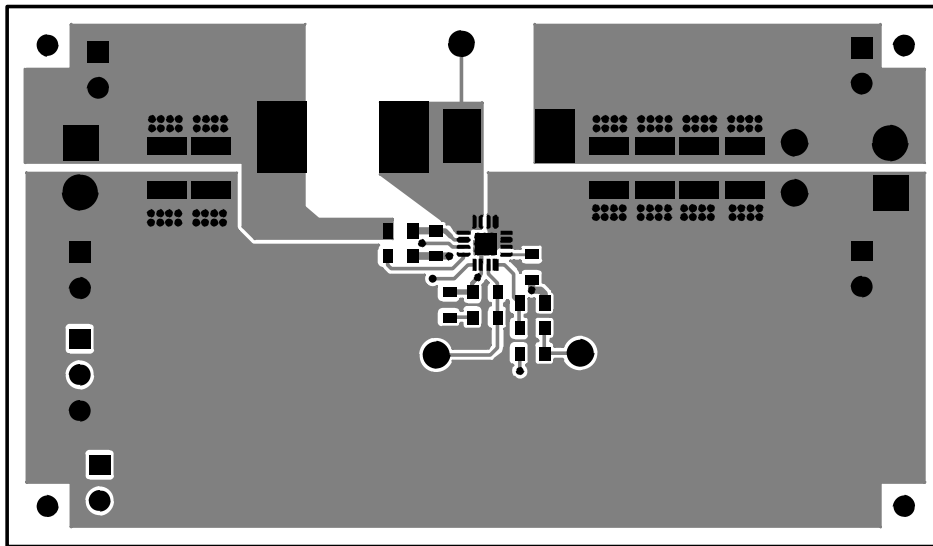

Figure 18. TPS55340EVM-017 Top-Side Layout

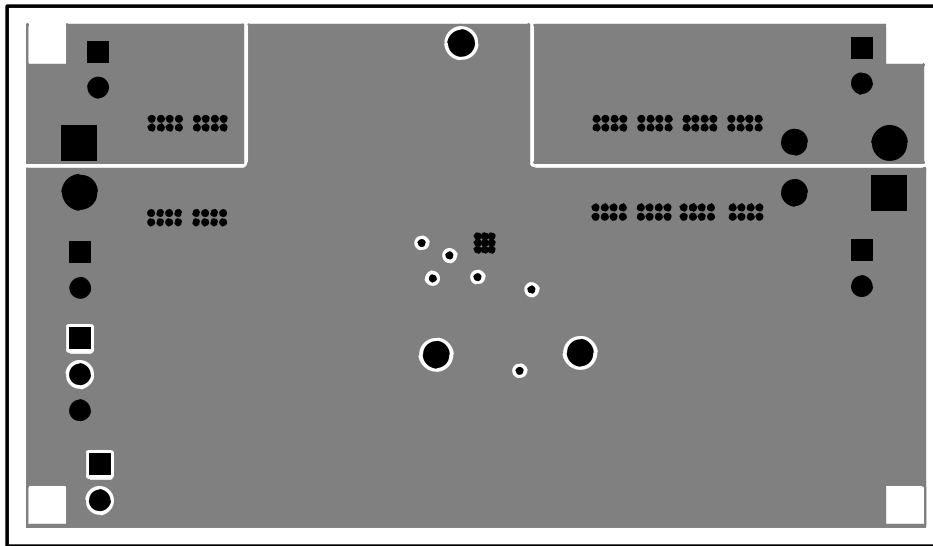

Figure 19. TPS55340EVM-017 Internal Layer-1 Layout

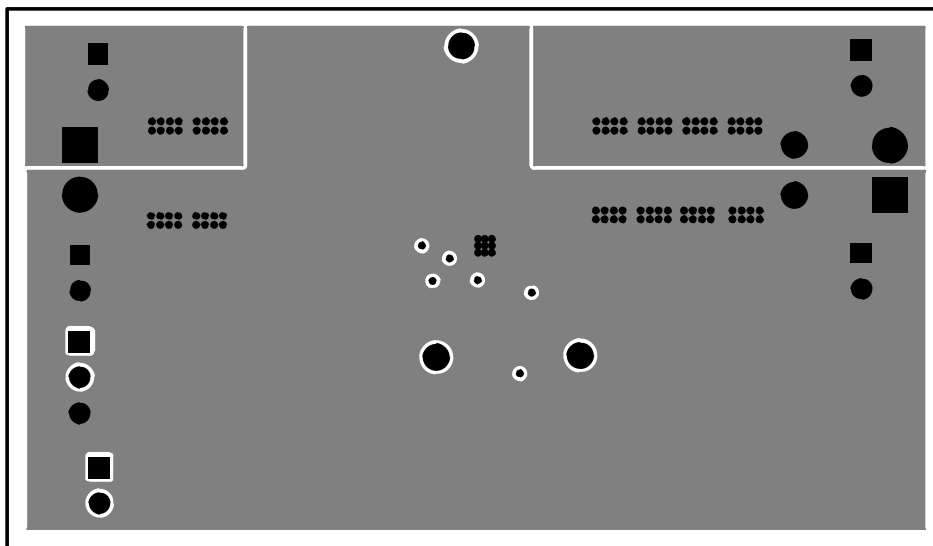

Figure 20. TPS55340EVM-017 Internal Layer-2 Layout

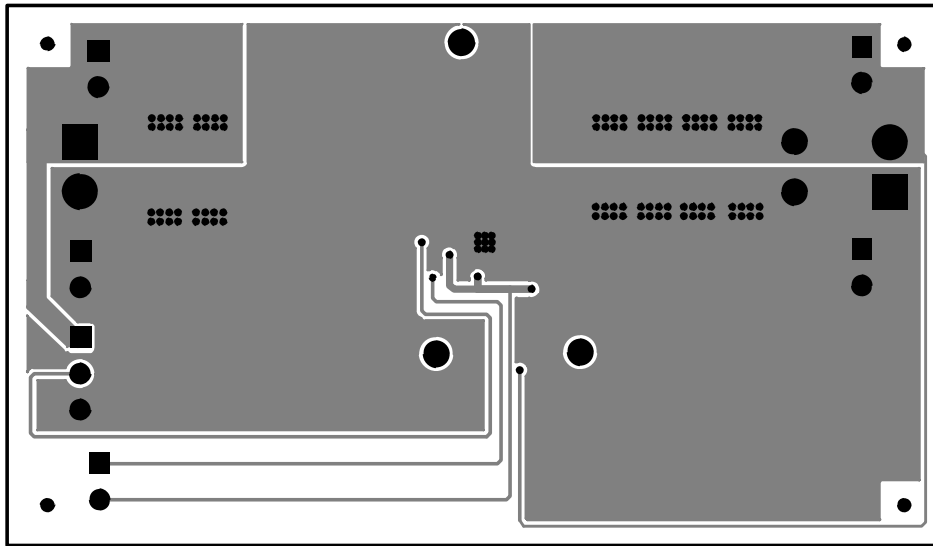

Figure 21. TPS55340EVM-017 Bottom-Side Layout

6 Schematic and Bill of Materials

This section presents the EVM schematic and bill of materials.

6.1 Schematic

Figure 22 is the schematic for the EVM.

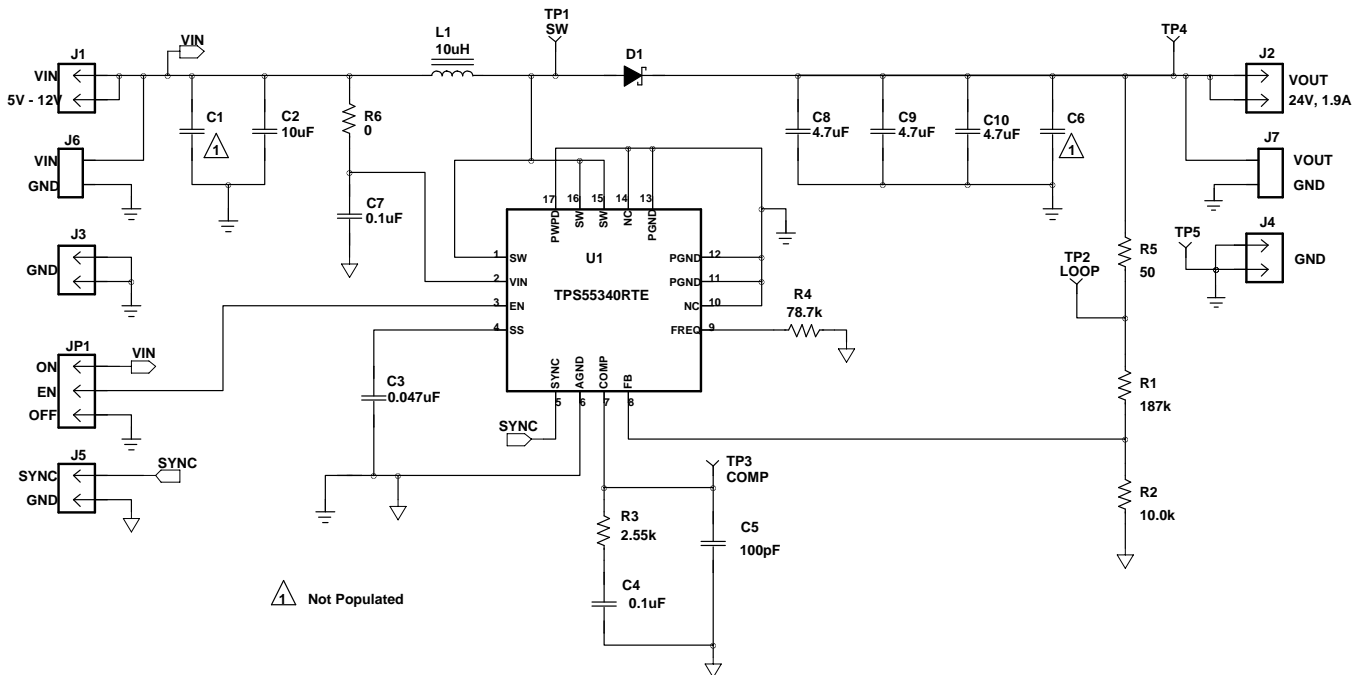

Figure 22. TPS55340EVM-017 Schematic

6.2 Bill of Materials

Table 4 presents the bill of materials for the EVM.

Table 4. TPS55340EVM-017 Bill of Materials

QTY	RefDes	Value	Description	Size	Part Number	MFR
0	C1	Open	Capacitor, ceramic, 35 V, X7R, 10%	1210	STD	STD
1	C2	10 μ F	Capacitor, ceramic, 35 V, X7R, 10%	1210	GRM32ER7YA106KA12L	Murata
1	C3	0.047 μ F	Capacitor, ceramic, 10 V, X7R, 10%	0603	STD	STD
1	C4	0.1 μ F	Capacitor, ceramic, 10 V, X7R, 10%	0603	STD	STD
1	C5	100 pF	Capacitor, ceramic, 10 V, X7R, 10%	0603	STD	STD
0	C6	Open	Capacitor, ceramic, 50 V, X7R, 10%	1210	STD	STD
1	C7	0.1 μ F	Capacitor, ceramic, 50 V, X7R, 10%	0603	STD	STD
3	C8-C10	4.7 μ F	Capacitor, ceramic, 50 V, X7R, 10%	1210	GRM32ER71H475KA88L	Murata
1	D1	8540C-13-F	Diode, Schottky, 5 A, 40 V	SMC	B540C-13-F	Diodes Inc
5	J1-5	PEC025AAN	Header, Male 2-pin, 100 mil spacing	0.100 x 2 in	PEC025AAN	Suffins
2	J6-7	ED555/2DS	Terminal block, 2 pin, 6 A, 3.5 mm	0.27 x 0.25 in	ED555/205	OST
1	JP1	PEC035AAN	Header, Male 3 pin, 100 mil spacing	0.100 x 3 in	PEC035AAN	Sullins
1	L1	10 μ H	Inductor, SMT, 12.5 A, 30 m Ω	0.400 x 0.453 in	74437368100	Würth Elektronik
1	R1	187 k Ω	Resistor, chip, 1/16W, 1%	0603	STD	STD
1	R2	10.0 k Ω	Resistor, chip, 1/16W, 1%	0603	STD	
1	R3	2.55 k Ω	Resistor, chip, 1/16W, 1%	0603	STD	
1	R4	78.7 k Ω	Resistor, chip, 1/16W, 1%	0603	STD	
1	R5	49.9 Ω	Resistor, chip, 1/16W, 1%	0603	STD	
1	R6	0 Ω	Resistor, chip, 1/16W, 1%	0603	STD	
1	SH1		Short jumper, 100 mil	0.100 in	929950-00	3M
1	TP5	5001	Test point, black, Thru Hole Color Keyed	0.100 x 0.100 in		Keystone
4	TP1-4	5000	Test point, red, thru hole color keyed	0.100 x 0.100 in		Keystone
1	U1	TPS55340RTE	IC, 5-A, 40-V, Boost Converter with Soft-start and Programmable Switching Frequency	QFN-16	TPS55340RTE	TI
1	--		PCB, 2.6 in x 1.5 in x 0.062 in		PWR017	Any

- Notes: 1. These assemblies are ESD sensitive, observe ESD precautions.
 2. These assemblies must be clean and free from flux and all contaminants. Use of no clean flux is not acceptable.
 3. These assemblies must comply with workmanship standards IPC-A-610 Class 2.
 4. Ref designators marked with an asterisk (***) cannot be substituted. All other components can be substituted with equivalent MFG's components.

6.3 Reference

1. *TPS55340, Integrated 5-A 40-V Boost/SEPIC/Flyback Converter with Adjustable Switching Frequency* data sheet (SLVSB04)

Revision History

NOTE: Page numbers for previous revisions may differ from page numbers in the current version.

Changes from A Revision (July 2012) to B Revision	Page
• Changed Figure 3 Image Object X-axis label to Input Voltage	5

Changes from Original (April 2012) to A Revision	Page
• Corrected Equation 1	3

STANDARD TERMS FOR EVALUATION MODULES

1. *Delivery:* TI delivers TI evaluation boards, kits, or modules, including any accompanying demonstration software, components, and/or documentation which may be provided together or separately (collectively, an "EVM" or "EVMs") to the User ("User") in accordance with the terms set forth herein. User's acceptance of the EVM is expressly subject to the following terms.
 - 1.1 EVMs are intended solely for product or software developers for use in a research and development setting to facilitate feasibility evaluation, experimentation, or scientific analysis of TI semiconductor products. EVMs have no direct function and are not finished products. EVMs shall not be directly or indirectly assembled as a part or subassembly in any finished product. For clarification, any software or software tools provided with the EVM ("Software") shall not be subject to the terms and conditions set forth herein but rather shall be subject to the applicable terms that accompany such Software
 - 1.2 EVMs are not intended for consumer or household use. EVMs may not be sold, sublicensed, leased, rented, loaned, assigned, or otherwise distributed for commercial purposes by Users, in whole or in part, or used in any finished product or production system.
2. *Limited Warranty and Related Remedies/Disclaimers:*
 - 2.1 These terms do not apply to Software. The warranty, if any, for Software is covered in the applicable Software License Agreement.
 - 2.2 TI warrants that the TI EVM will conform to TI's published specifications for ninety (90) days after the date TI delivers such EVM to User. Notwithstanding the foregoing, TI shall not be liable for a nonconforming EVM if (a) the nonconformity was caused by neglect, misuse or mistreatment by an entity other than TI, including improper installation or testing, or for any EVMs that have been altered or modified in any way by an entity other than TI, (b) the nonconformity resulted from User's design, specifications or instructions for such EVMs or improper system design, or (c) User has not paid on time. Testing and other quality control techniques are used to the extent TI deems necessary. TI does not test all parameters of each EVM. User's claims against TI under this Section 2 are void if User fails to notify TI of any apparent defects in the EVMs within ten (10) business days after delivery, or of any hidden defects with ten (10) business days after the defect has been detected.
 - 2.3 TI's sole liability shall be at its option to repair or replace EVMs that fail to conform to the warranty set forth above, or credit User's account for such EVM. TI's liability under this warranty shall be limited to EVMs that are returned during the warranty period to the address designated by TI and that are determined by TI not to conform to such warranty. If TI elects to repair or replace such EVM, TI shall have a reasonable time to repair such EVM or provide replacements. Repaired EVMs shall be warranted for the remainder of the original warranty period. Replaced EVMs shall be warranted for a new full ninety (90) day warranty period.

WARNING

Evaluation Kits are intended solely for use by technically qualified, professional electronics experts who are familiar with the dangers and application risks associated with handling electrical mechanical components, systems, and subsystems.

User shall operate the Evaluation Kit within TI's recommended guidelines and any applicable legal or environmental requirements as well as reasonable and customary safeguards. Failure to set up and/or operate the Evaluation Kit within TI's recommended guidelines may result in personal injury or death or property damage. Proper set up entails following TI's instructions for electrical ratings of interface circuits such as input, output and electrical loads.

NOTE:

EXPOSURE TO ELECTROSTATIC DISCHARGE (ESD) MAY CAUSE DEGRADATION OR FAILURE OF THE EVALUATION KIT; TI RECOMMENDS STORAGE OF THE EVALUATION KIT IN A PROTECTIVE ESD BAG.

3 Regulatory Notices:

3.1 United States

3.1.1 Notice applicable to EVMs not FCC-Approved:

FCC NOTICE: This kit is designed to allow product developers to evaluate electronic components, circuitry, or software associated with the kit to determine whether to incorporate such items in a finished product and software developers to write software applications for use with the end product. This kit is not a finished product and when assembled may not be resold or otherwise marketed unless all required FCC equipment authorizations are first obtained. Operation is subject to the condition that this product not cause harmful interference to licensed radio stations and that this product accept harmful interference. Unless the assembled kit is designed to operate under part 15, part 18 or part 95 of this chapter, the operator of the kit must operate under the authority of an FCC license holder or must secure an experimental authorization under part 5 of this chapter.

3.1.2 For EVMs annotated as FCC – FEDERAL COMMUNICATIONS COMMISSION Part 15 Compliant:

CAUTION

This device complies with part 15 of the FCC Rules. Operation is subject to the following two conditions: (1) This device may not cause harmful interference, and (2) this device must accept any interference received, including interference that may cause undesired operation.

Changes or modifications not expressly approved by the party responsible for compliance could void the user's authority to operate the equipment.

FCC Interference Statement for Class A EVM devices

NOTE: This equipment has been tested and found to comply with the limits for a Class A digital device, pursuant to part 15 of the FCC Rules. These limits are designed to provide reasonable protection against harmful interference when the equipment is operated in a commercial environment. This equipment generates, uses, and can radiate radio frequency energy and, if not installed and used in accordance with the instruction manual, may cause harmful interference to radio communications. Operation of this equipment in a residential area is likely to cause harmful interference in which case the user will be required to correct the interference at his own expense.

FCC Interference Statement for Class B EVM devices

NOTE: This equipment has been tested and found to comply with the limits for a Class B digital device, pursuant to part 15 of the FCC Rules. These limits are designed to provide reasonable protection against harmful interference in a residential installation. This equipment generates, uses and can radiate radio frequency energy and, if not installed and used in accordance with the instructions, may cause harmful interference to radio communications. However, there is no guarantee that interference will not occur in a particular installation. If this equipment does cause harmful interference to radio or television reception, which can be determined by turning the equipment off and on, the user is encouraged to try to correct the interference by one or more of the following measures:

- Reorient or relocate the receiving antenna.
- Increase the separation between the equipment and receiver.
- Connect the equipment into an outlet on a circuit different from that to which the receiver is connected.
- Consult the dealer or an experienced radio/TV technician for help.

3.2 Canada

3.2.1 For EVMs issued with an Industry Canada Certificate of Conformance to RSS-210 or RSS-247

Concerning EVMs Including Radio Transmitters:

This device complies with Industry Canada license-exempt RSSs. Operation is subject to the following two conditions:

(1) this device may not cause interference, and (2) this device must accept any interference, including interference that may cause undesired operation of the device.

Concernant les EVMs avec appareils radio:

Le présent appareil est conforme aux CNR d'Industrie Canada applicables aux appareils radio exempts de licence. L'exploitation est autorisée aux deux conditions suivantes: (1) l'appareil ne doit pas produire de brouillage, et (2) l'utilisateur de l'appareil doit accepter tout brouillage radioélectrique subi, même si le brouillage est susceptible d'en compromettre le fonctionnement.

Concerning EVMs Including Detachable Antennas:

Under Industry Canada regulations, this radio transmitter may only operate using an antenna of a type and maximum (or lesser) gain approved for the transmitter by Industry Canada. To reduce potential radio interference to other users, the antenna type and its gain should be so chosen that the equivalent isotropically radiated power (e.i.r.p.) is not more than that necessary for successful communication. This radio transmitter has been approved by Industry Canada to operate with the antenna types listed in the user guide with the maximum permissible gain and required antenna impedance for each antenna type indicated. Antenna types not included in this list, having a gain greater than the maximum gain indicated for that type, are strictly prohibited for use with this device.

Concernant les EVMs avec antennes détachables

Conformément à la réglementation d'Industrie Canada, le présent émetteur radio peut fonctionner avec une antenne d'un type et d'un gain maximal (ou inférieur) approuvé pour l'émetteur par Industrie Canada. Dans le but de réduire les risques de brouillage radioélectrique à l'intention des autres utilisateurs, il faut choisir le type d'antenne et son gain de sorte que la puissance isotrope rayonnée équivalente (p.i.r.e.) ne dépasse pas l'intensité nécessaire à l'établissement d'une communication satisfaisante. Le présent émetteur radio a été approuvé par Industrie Canada pour fonctionner avec les types d'antenne énumérés dans le manuel d'usage et ayant un gain admissible maximal et l'impédance requise pour chaque type d'antenne. Les types d'antenne non inclus dans cette liste, ou dont le gain est supérieur au gain maximal indiqué, sont strictement interdits pour l'exploitation de l'émetteur.

3.3 Japan

3.3.1 *Notice for EVMs delivered in Japan:* Please see http://www.tij.co.jp/lstds/ti_ja/general/eStore/notice_01.page 日本国内に輸入される評価用キット、ボードについては、次のところをご覧ください。
http://www.tij.co.jp/lstds/ti_ja/general/eStore/notice_01.page

3.3.2 *Notice for Users of EVMs Considered "Radio Frequency Products" in Japan:* EVMs entering Japan may not be certified by TI as conforming to Technical Regulations of Radio Law of Japan.

If User uses EVMs in Japan, not certified to Technical Regulations of Radio Law of Japan, User is required to follow the instructions set forth by Radio Law of Japan, which includes, but is not limited to, the instructions below with respect to EVMs (which for the avoidance of doubt are stated strictly for convenience and should be verified by User):

1. Use EVMs in a shielded room or any other test facility as defined in the notification #173 issued by Ministry of Internal Affairs and Communications on March 28, 2006, based on Sub-section 1.1 of Article 6 of the Ministry's Rule for Enforcement of Radio Law of Japan,
2. Use EVMs only after User obtains the license of Test Radio Station as provided in Radio Law of Japan with respect to EVMs, or
3. Use of EVMs only after User obtains the Technical Regulations Conformity Certification as provided in Radio Law of Japan with respect to EVMs. Also, do not transfer EVMs, unless User gives the same notice above to the transferee. Please note that if User does not follow the instructions above, User will be subject to penalties of Radio Law of Japan.

【無線電波を送信する製品の開発キットをお使いになる際の注意事項】 開発キットの中には技術基準適合証明を受けていないものがあります。技術適合証明を受けていないものご使用に際しては、電波法遵守のため、以下のいずれかの措置を取っていただく必要がありますのでご注意ください。

1. 電波法施行規則第6条第1項第1号に基づく平成18年3月28日総務省告示第173号で定められた電波暗室等の試験設備でご使用いただく。
2. 実験局の免許を取得後ご使用いただく。
3. 技術基準適合証明を取得後ご使用いただく。

なお、本製品は、上記の「ご使用にあたっての注意」を譲渡先、移転先に通知しない限り、譲渡、移転できないものとします。

上記を遵守頂けない場合は、電波法の罰則が適用される可能性があることをご留意ください。日本テキサス・インスツルメンツ株式会社

東京都新宿区西新宿 6 丁目 2 4 番 1 号
西新宿三井ビル

3.3.3 *Notice for EVMs for Power Line Communication:* Please see http://www.tij.co.jp/lstds/ti_ja/general/eStore/notice_02.page 電力線搬送波通信についての開発キットをお使いになる際の注意事項については、次のところをご覧ください。
http://www.tij.co.jp/lstds/ti_ja/general/eStore/notice_02.page

3.4 European Union

3.4.1 *For EVMs subject to EU Directive 2014/30/EU (Electromagnetic Compatibility Directive):*

This is a class A product intended for use in environments other than domestic environments that are connected to a low-voltage power-supply network that supplies buildings used for domestic purposes. In a domestic environment this product may cause radio interference in which case the user may be required to take adequate measures.

- 4 *EVM Use Restrictions and Warnings:*
 - 4.1 EVMS ARE NOT FOR USE IN FUNCTIONAL SAFETY AND/OR SAFETY CRITICAL EVALUATIONS, INCLUDING BUT NOT LIMITED TO EVALUATIONS OF LIFE SUPPORT APPLICATIONS.
 - 4.2 User must read and apply the user guide and other available documentation provided by TI regarding the EVM prior to handling or using the EVM, including without limitation any warning or restriction notices. The notices contain important safety information related to, for example, temperatures and voltages.
 - 4.3 *Safety-Related Warnings and Restrictions:*
 - 4.3.1 User shall operate the EVM within TI's recommended specifications and environmental considerations stated in the user guide, other available documentation provided by TI, and any other applicable requirements and employ reasonable and customary safeguards. Exceeding the specified performance ratings and specifications (including but not limited to input and output voltage, current, power, and environmental ranges) for the EVM may cause personal injury or death, or property damage. If there are questions concerning performance ratings and specifications, User should contact a TI field representative prior to connecting interface electronics including input power and intended loads. Any loads applied outside of the specified output range may also result in unintended and/or inaccurate operation and/or possible permanent damage to the EVM and/or interface electronics. Please consult the EVM user guide prior to connecting any load to the EVM output. If there is uncertainty as to the load specification, please contact a TI field representative. During normal operation, even with the inputs and outputs kept within the specified allowable ranges, some circuit components may have elevated case temperatures. These components include but are not limited to linear regulators, switching transistors, pass transistors, current sense resistors, and heat sinks, which can be identified using the information in the associated documentation. When working with the EVM, please be aware that the EVM may become very warm.
 - 4.3.2 EVMs are intended solely for use by technically qualified, professional electronics experts who are familiar with the dangers and application risks associated with handling electrical mechanical components, systems, and subsystems. User assumes all responsibility and liability for proper and safe handling and use of the EVM by User or its employees, affiliates, contractors or designees. User assumes all responsibility and liability to ensure that any interfaces (electronic and/or mechanical) between the EVM and any human body are designed with suitable isolation and means to safely limit accessible leakage currents to minimize the risk of electrical shock hazard. User assumes all responsibility and liability for any improper or unsafe handling or use of the EVM by User or its employees, affiliates, contractors or designees.
 - 4.4 User assumes all responsibility and liability to determine whether the EVM is subject to any applicable international, federal, state, or local laws and regulations related to User's handling and use of the EVM and, if applicable, User assumes all responsibility and liability for compliance in all respects with such laws and regulations. User assumes all responsibility and liability for proper disposal and recycling of the EVM consistent with all applicable international, federal, state, and local requirements.
5. *Accuracy of Information:* To the extent TI provides information on the availability and function of EVMs, TI attempts to be as accurate as possible. However, TI does not warrant the accuracy of EVM descriptions, EVM availability or other information on its websites as accurate, complete, reliable, current, or error-free.
6. *Disclaimers:*
 - 6.1 EXCEPT AS SET FORTH ABOVE, EVMS AND ANY MATERIALS PROVIDED WITH THE EVM (INCLUDING, BUT NOT LIMITED TO, REFERENCE DESIGNS AND THE DESIGN OF THE EVM ITSELF) ARE PROVIDED "AS IS" AND "WITH ALL FAULTS." TI DISCLAIMS ALL OTHER WARRANTIES, EXPRESS OR IMPLIED, REGARDING SUCH ITEMS, INCLUDING BUT NOT LIMITED TO ANY EPIDEMIC FAILURE WARRANTY OR IMPLIED WARRANTIES OF MERCHANTABILITY OR FITNESS FOR A PARTICULAR PURPOSE OR NON-INFRINGEMENT OF ANY THIRD PARTY PATENTS, COPYRIGHTS, TRADE SECRETS OR OTHER INTELLECTUAL PROPERTY RIGHTS.
 - 6.2 EXCEPT FOR THE LIMITED RIGHT TO USE THE EVM SET FORTH HEREIN, NOTHING IN THESE TERMS SHALL BE CONSTRUED AS GRANTING OR CONFERRING ANY RIGHTS BY LICENSE, PATENT, OR ANY OTHER INDUSTRIAL OR INTELLECTUAL PROPERTY RIGHT OF TI, ITS SUPPLIERS/LICENSORS OR ANY OTHER THIRD PARTY, TO USE THE EVM IN ANY FINISHED END-USER OR READY-TO-USE FINAL PRODUCT, OR FOR ANY INVENTION, DISCOVERY OR IMPROVEMENT, REGARDLESS OF WHEN MADE, CONCEIVED OR ACQUIRED.
7. *USER'S INDEMNITY OBLIGATIONS AND REPRESENTATIONS.* USER WILL DEFEND, INDEMNIFY AND HOLD TI, ITS LICENSORS AND THEIR REPRESENTATIVES HARMLESS FROM AND AGAINST ANY AND ALL CLAIMS, DAMAGES, LOSSES, EXPENSES, COSTS AND LIABILITIES (COLLECTIVELY, "CLAIMS") ARISING OUT OF OR IN CONNECTION WITH ANY HANDLING OR USE OF THE EVM THAT IS NOT IN ACCORDANCE WITH THESE TERMS. THIS OBLIGATION SHALL APPLY WHETHER CLAIMS ARISE UNDER STATUTE, REGULATION, OR THE LAW OF TORT, CONTRACT OR ANY OTHER LEGAL THEORY, AND EVEN IF THE EVM FAILS TO PERFORM AS DESCRIBED OR EXPECTED.

8. *Limitations on Damages and Liability:*

8.1 *General Limitations.* IN NO EVENT SHALL TI BE LIABLE FOR ANY SPECIAL, COLLATERAL, INDIRECT, PUNITIVE, INCIDENTAL, CONSEQUENTIAL, OR EXEMPLARY DAMAGES IN CONNECTION WITH OR ARISING OUT OF THESE TERMS OR THE USE OF THE EVMS , REGARDLESS OF WHETHER TI HAS BEEN ADVISED OF THE POSSIBILITY OF SUCH DAMAGES. EXCLUDED DAMAGES INCLUDE, BUT ARE NOT LIMITED TO, COST OF REMOVAL OR REINSTALLATION, ANCILLARY COSTS TO THE PROCUREMENT OF SUBSTITUTE GOODS OR SERVICES, RETESTING, OUTSIDE COMPUTER TIME, LABOR COSTS, LOSS OF GOODWILL, LOSS OF PROFITS, LOSS OF SAVINGS, LOSS OF USE, LOSS OF DATA, OR BUSINESS INTERRUPTION. NO CLAIM, SUIT OR ACTION SHALL BE BROUGHT AGAINST TI MORE THAN TWELVE (12) MONTHS AFTER THE EVENT THAT GAVE RISE TO THE CAUSE OF ACTION HAS OCCURRED.

8.2 *Specific Limitations.* IN NO EVENT SHALL TI'S AGGREGATE LIABILITY FROM ANY USE OF AN EVM PROVIDED HEREUNDER, INCLUDING FROM ANY WARRANTY, INDEMNITY OR OTHER OBLIGATION ARISING OUT OF OR IN CONNECTION WITH THESE TERMS, , EXCEED THE TOTAL AMOUNT PAID TO TI BY USER FOR THE PARTICULAR EVM(S) AT ISSUE DURING THE PRIOR TWELVE (12) MONTHS WITH RESPECT TO WHICH LOSSES OR DAMAGES ARE CLAIMED. THE EXISTENCE OF MORE THAN ONE CLAIM SHALL NOT ENLARGE OR EXTEND THIS LIMIT.

9. *Return Policy.* Except as otherwise provided, TI does not offer any refunds, returns, or exchanges. Furthermore, no return of EVM(s) will be accepted if the package has been opened and no return of the EVM(s) will be accepted if they are damaged or otherwise not in a resalable condition. If User feels it has been incorrectly charged for the EVM(s) it ordered or that delivery violates the applicable order, User should contact TI. All refunds will be made in full within thirty (30) working days from the return of the components(s), excluding any postage or packaging costs.

10. *Governing Law:* These terms and conditions shall be governed by and interpreted in accordance with the laws of the State of Texas, without reference to conflict-of-laws principles. User agrees that non-exclusive jurisdiction for any dispute arising out of or relating to these terms and conditions lies within courts located in the State of Texas and consents to venue in Dallas County, Texas. Notwithstanding the foregoing, any judgment may be enforced in any United States or foreign court, and TI may seek injunctive relief in any United States or foreign court.

Mailing Address: Texas Instruments, Post Office Box 655303, Dallas, Texas 75265
Copyright © 2019, Texas Instruments Incorporated

IMPORTANT NOTICE AND DISCLAIMER

TI PROVIDES TECHNICAL AND RELIABILITY DATA (INCLUDING DATASHEETS), DESIGN RESOURCES (INCLUDING REFERENCE DESIGNS), APPLICATION OR OTHER DESIGN ADVICE, WEB TOOLS, SAFETY INFORMATION, AND OTHER RESOURCES "AS IS" AND WITH ALL FAULTS, AND DISCLAIMS ALL WARRANTIES, EXPRESS AND IMPLIED, INCLUDING WITHOUT LIMITATION ANY IMPLIED WARRANTIES OF MERCHANTABILITY, FITNESS FOR A PARTICULAR PURPOSE OR NON-INFRINGEMENT OF THIRD PARTY INTELLECTUAL PROPERTY RIGHTS.

These resources are intended for skilled developers designing with TI products. You are solely responsible for (1) selecting the appropriate TI products for your application, (2) designing, validating and testing your application, and (3) ensuring your application meets applicable standards, and any other safety, security, or other requirements. These resources are subject to change without notice. TI grants you permission to use these resources only for development of an application that uses the TI products described in the resource. Other reproduction and display of these resources is prohibited. No license is granted to any other TI intellectual property right or to any third party intellectual property right. TI disclaims responsibility for, and you will fully indemnify TI and its representatives against, any claims, damages, costs, losses, and liabilities arising out of your use of these resources.

TI's products are provided subject to TI's Terms of Sale (www.ti.com/legal/termsofsale.html) or other applicable terms available either on ti.com or provided in conjunction with such TI products. TI's provision of these resources does not expand or otherwise alter TI's applicable warranties or warranty disclaimers for TI products.

Mailing Address: Texas Instruments, Post Office Box 655303, Dallas, Texas 75265
Copyright © 2019, Texas Instruments Incorporated

Looking for pricing, stock, or lifecycle information?

Click below to explore more details on WIN SOURCE:

 [View TPS55340EVM-017](#) on WIN SOURCE

 [Texas Instruments](#) Information

Optimize Your Supply Chain with WIN SOURCE Solutions

-  Global Sourcing Solution
-  Obsolete Management
-  Cost Control Management
-  Shortage Management
-  Alternative Solution
-  Excess Inventory Management